

# Teaching mathematics

to students who are blind  
or visually impaired

Ilse Disseldorp  
Annemiek van Leendert  
George Willy Kutosi  
Paul Mundy

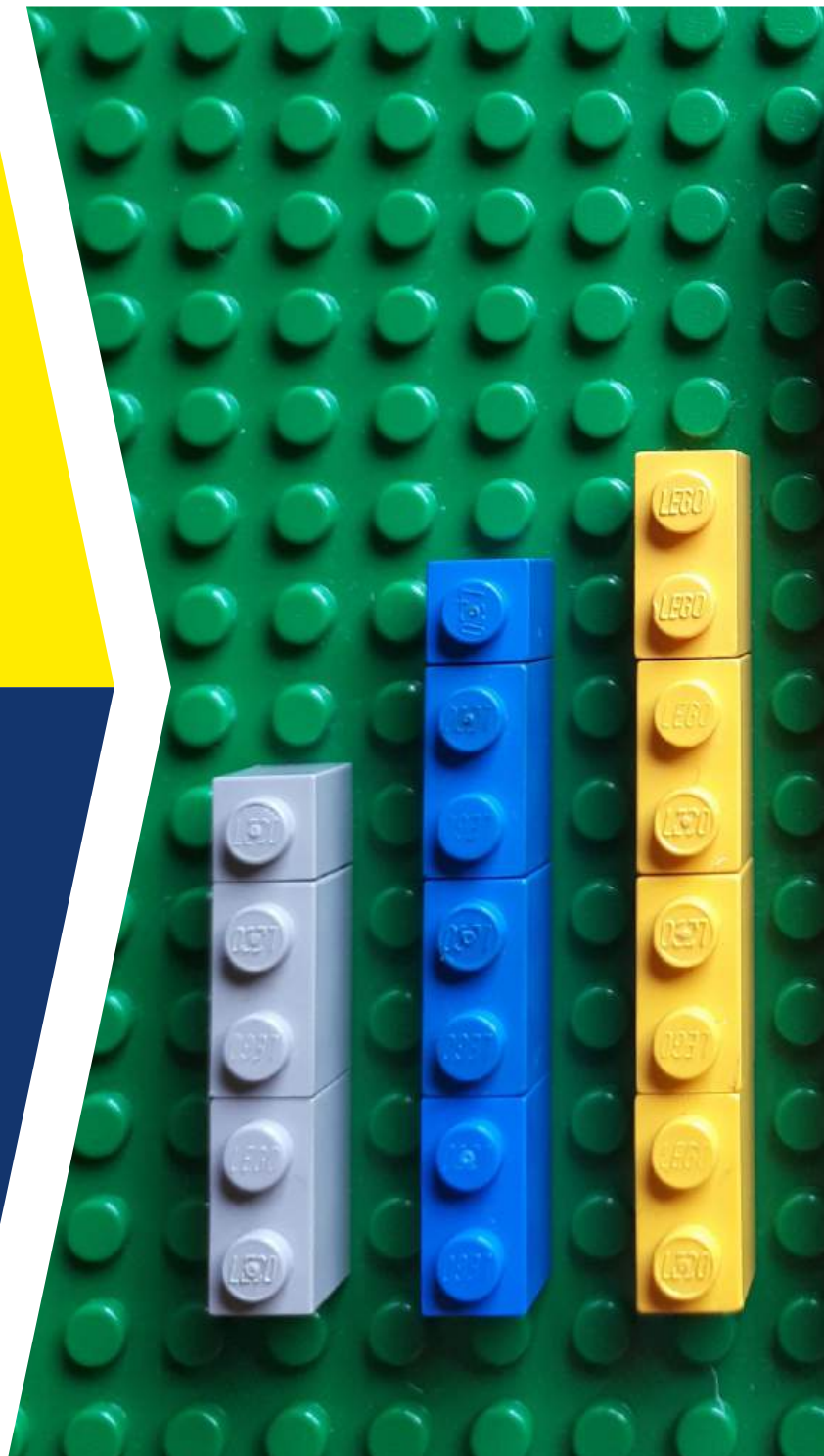

# Teaching mathematics to students who are blind or visually impaired

## Authors

Ilse Disseldorp

[ilsedisseldorp@visio.org](mailto:ilsedisseldorp@visio.org)

Annemiek van Leendert

[annemiekleendert@visio.org](mailto:annemiekleendert@visio.org)

George Willy Kutosi

[geowilkuts@gmail.com](mailto:geowilkuts@gmail.com)

Paul Mundy

[paul@mamud.com](mailto:paul@mamud.com)

## Editing

Paul Mundy

## Coordinator

Petra Wijen

[petrawijen@visio.org](mailto:petrawijen@visio.org)

## Basic design

Weijsters & Kooij vormgevers

## Layout

Makes Sense design

## Published by Royal Visio

PO Box 1180, 1270 BD Huizen, Netherlands. [www.visio.org](http://www.visio.org)

The utmost care has been taken in the preparation of this publication. The authors and publisher accept no liability for information that is nevertheless incomplete or incorrect. For questions, remarks or more information please write to: [international@visio.org](mailto:international@visio.org)

## Copyright

This publication is licensed under a Creative Commons Attribution-NonCommercial-ShareAlike 4.0 International (CC BY-NC-SA 4.0).



[creativecommons.org/licenses/by-nc-sa/4.0/deed.en\\_GB](http://creativecommons.org/licenses/by-nc-sa/4.0/deed.en_GB)

You are free to:

- **Share copy and redistribute** the material in any medium or format
- **Adapt, remix, transform, and build upon** the material under the following terms:
  - **Attribution** - You must give appropriate credit, provide a link to the license, and indicate if changes were made. You may do so in any reasonable manner, but not in any way that suggests the licensor endorses you or your use.
  - **NonCommercial** - You may not use the material for commercial purposes.

- **ShareAlike** - If you remix, transform, or build upon the material, you must distribute your contributions under the same license as the original.
- **No additional restrictions** - You may not apply legal terms or technological measures that legally restrict others from doing anything the license permits.

## Citation

Ilse Disseldorp, Annemiek van Leendert, George Willy Kutosi and Paul Mundy. 2023. Teaching mathematics to students who are blind or visually impaired. Royal Visio, Huizen, Netherlands.

## Photo cover

Paul Mundy

## Photography

Ilse Disseldorp  
 Amton Mbangeni  
 Paul Mundy  
 Annemiek van Leendert  
 Samia Serry  
 Visio/Gyntha Goertz

## Other photos

- americanthermoform.com
- Annielogue/Wikipedia (CC BY-SA 3.0)
- American Printing House, aph.org
- augenbit.de
- Aurora Europe
- Catiga
- ceciaa.com
- eduvip.nl
- Eren Li/pexels.com
- examenblad.nl
- eyoyousa.com
- Felix Winkelkemper/Wikipedia (CC BY-SA 4.0)
- Florida School for the Deaf and the Blind in St Augustine
- future-visions.tech
- Gwyn McCormack/Paths to Literacy
- Harpo
- healthcentral.com
- How to clay
- Humanware
- IDEK/Amazon
- klongdinsor.com
- large-print-apps.com
- learningresources.com
- lehrerwelt.de
- lipikagupta.com
- mathlearningcenter.org
- maxiaids.com
- melissaanddoug.com
- Morkka
- MTA, Modern Teaching Aids, teaching.com.au
- MyScript Calculator 2
- perkins.org
- playvisions.com
- resourcesfortheblind.org
- rnib.org.uk
- Romina Santarelli / Secretaría de Cultura de la Nación (CC BY-SA 2.0)
- Rosenfeld Media (CC BY 2.0)
- starplylam.com
- startsomegood.com
- Talking Scientific Calculator
- Texas Instruments, Casio
- thingiverse.com
- tiflonexos.org
- timetex.de
- ubuy.co.it
- Visio Sensemath
- Walmart
- wecarewebridge.in

# Contents

<b>Introduction</b>	<b>5</b>
Who is this book for?	7
What do we mean by blind or visually impaired?	7
<b>Part 1</b>	<b>9</b>
<b>Teaching methods</b>	<b>9</b>
1.1 Challenges faced by learners	9
1.2 Challenges faced by teachers	12
1.3 Expanded mathematics core curriculum	14
1.4 Teaching techniques	17
1.5 Where to teach maths to blind students?	19
1.6 Classroom management	19
1.7 Working with parents	20
1.8 Adapting materials	20
1.9 Textbooks for braille students	21
1.10 Support maths teachers and teaching assistants	23
1.11 Resource room	27
<b>Part 2</b>	<b>29</b>
<b>Equipment and teaching materials</b>	<b>29</b>
2.1 Where to get equipment and teaching materials	30
2.2 Alternative tools for teaching maths	30
2.3 Text	34
2.4 Counting and arithmetic tools	39
2.5 Mental arithmetic	44
2.6 Drawings and graphs	50
2.7 Measurement and drawing tools	71
2.8 3D objects and models	80
2.9 Abacus	90
2.10 Calculators	94
2.11 Computers	109
2.12 Braille	113
2.13 Cube frame or cubarithm	148
2.14 Taylor frame	153
<b>Part 3</b>	<b>164</b>
<b>Teaching specific subjects</b>	<b>164</b>
3.1 Long arithmetic	165
3.2 Algebra	177
3.3 Drawing	190
3.4 Plane geometry	202
3.5 3D geometry	213
3.6 Graphs	232
3.7 Tables	246
3.8 Probability	251
3.9 Statistics	257

# Introduction



Mathematics is a fundamental part of our daily lives. Numbers, shapes and formulae are all around us: in money, measurements, work, the household, and leisure. Reading diagrams, understanding the news, measuring recipe ingredients, paying bills, going shopping and checking change, and even playing board games – they all depend on an understanding of maths and the ability to manipulate figures. Many jobs rely on the ability to measure and calculate. Maths is vital to an understanding of many other fields: especially the sciences and social sciences. Along with a very few other subjects – most importantly literacy in your native language – it is a passport to higher education and to many jobs.

While maths is abstract, it is also a very visual subject. For the blind or visually impaired, numbers, equations, shapes, graphs and tables pose special challenges. Counting objects involves feeling for each object in turn. Simple arithmetic involves holding a set of numbers in the head, then

performing calculations on them. Performing more complex calculations requires special equipment, such as a braille or a talking calculator. Equations (algebra), geometry (the hypotenuse of a triangle) and graphs (the shape of a parabola) must be explained in words or converted into tactile forms. Maths is often a feat of memory as much as one of understanding or analytical ability.

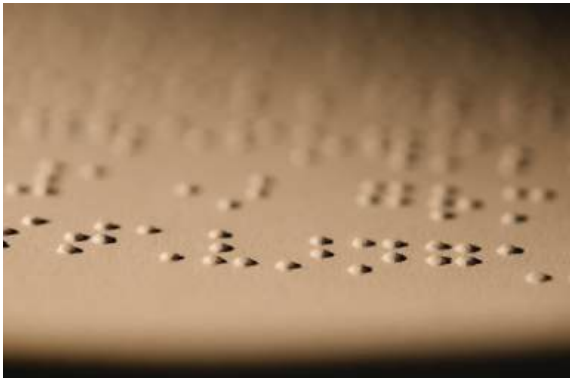

Braille consists of patterns of raised dots embossed into paper. Each pattern represents a letter, number or other character. The dots can be read with the fingertips.



A Perkins braille is a typewriter used to emboss braille into paper.

As a result, blind and visually impaired students lag behind sighted students in maths lessons. They underperform in maths compared to other subjects, and they are less likely to take advanced maths classes. Many maths teachers also lack the skills to teach blind and visually impaired students. A vicious circle results: the students fall behind in the class, and the teacher neglects their needs, causing them to fall behind even further. In too many schools and in too many countries, blind and visually impaired students are excluded from maths classes altogether as “the subject is too difficult for them”. Even if they are included, little extra effort is made to ensure they can learn along with their sighted peers. That leaves them at a permanent disadvantage both in school and in later life.

Education is not a privilege: it is a human right – one that must be made available to all without discrimination, including to the blind and visually impaired. An ability in maths makes it possible for them to be integrated into society as par as possible. A training in spatial, logical and numerical terms gained through mathematics stimulates brain development and makes it possible for the blind and visually impaired to function more easily in their families, communities, economy and society. It also helps them appreciate the world around them in ways that would otherwise be closed to them.

Mathematics is a multifaceted and multi-layered subject. Each new layer builds on the one before it: arithmetic builds on counting; algebra builds on arithmetic; and calculus builds on algebra. Trigonometry builds on both algebra and an understanding of shapes. Statistics is based on probability and graphs. Mastering each new sub-field depends on a mastery of those preceding it. Failure to master one of the basic fields makes it far more difficult to learn the layer built on top of it.

With the right teaching methods, and given some extra time, many blind and visually impaired students are capable of doing mathematics at a level comparable to sighted students.

## Who is this book for?

This manual is aimed at maths teachers, maths support teachers, resource-room teachers and teaching assistants who work with blind and visually impaired students. These may be:

- In special schools that cater especially to such learners.
- In regular schools where there may be one or two such learners in a class of sighted students.

The manual aims to provide you with the skills and knowledge that you need to help these learners achieve fluency in maths.

This manual does not attempt to provide all the skills and exercises that a student will cover during several years of maths classes. Rather, it gives guidelines for how to adapt your curriculum and teaching methods for the blind or visually impaired students in your class.

The manual focuses on the mathematics taught in secondary schools. It assumes that the students already have a knowledge of primary maths: numbers, arithmetic, clocks, 2- and 3-dimensional shapes, etc. For blind students, it assumes that they have already mastered the basics of braille. They will need to learn braille notation for mathematics as they are introduced to each concept.

Many different ways of representing mathematics in braille exist. This manual uses **Unified English Braille**, the system used in most of the English-speaking world. See the section on **Braille** in Part 2 for details.

## What do we mean by blind or visually impaired?

This manual discusses teaching mathematics for the blind and visually impaired. That includes learners who are blind as well as those who have low vision. Visual impairments range from mild, moderate and severe, to total blindness. The ideas in this book are likely to be useful for learners with moderate to severe visual impairments, and for those who are blind.

**Visual acuity** is tested by an optician using a standard letter chart.

- **Normal vision** is known as 6/6 (or 20/20) vision. This is what a person with good sight can see at a distance of 6 metres (or 20 feet). On the eye-testing chart, it means the person can read one of the rows of small letters near the bottom of the chart from 6 metres away.
- A person with **mild visual impairment** has a visual acuity of between 6/12 and 6/18: they can see at a distance of 6 metres what a person with normal sight can see from 12 metres away. That means they have to be closer to the object. At the standard distance of 6 metres, the person can read only the rows of larger letters on the test chart.
- A **moderate visual impairment** is where the person has a visual acuity of between 6/18 and 6/60. They can read the top letter in the chart and perhaps one or two rows of smaller letters below it.
- A **severe visual impairment** is a visual acuity of between 6/60 and 3/60. This person cannot read the biggest letter of the chart.
- **Functional blindness** is a visual acuity of worse than 3/60.
- **Total blindness** is no perception of light at all.

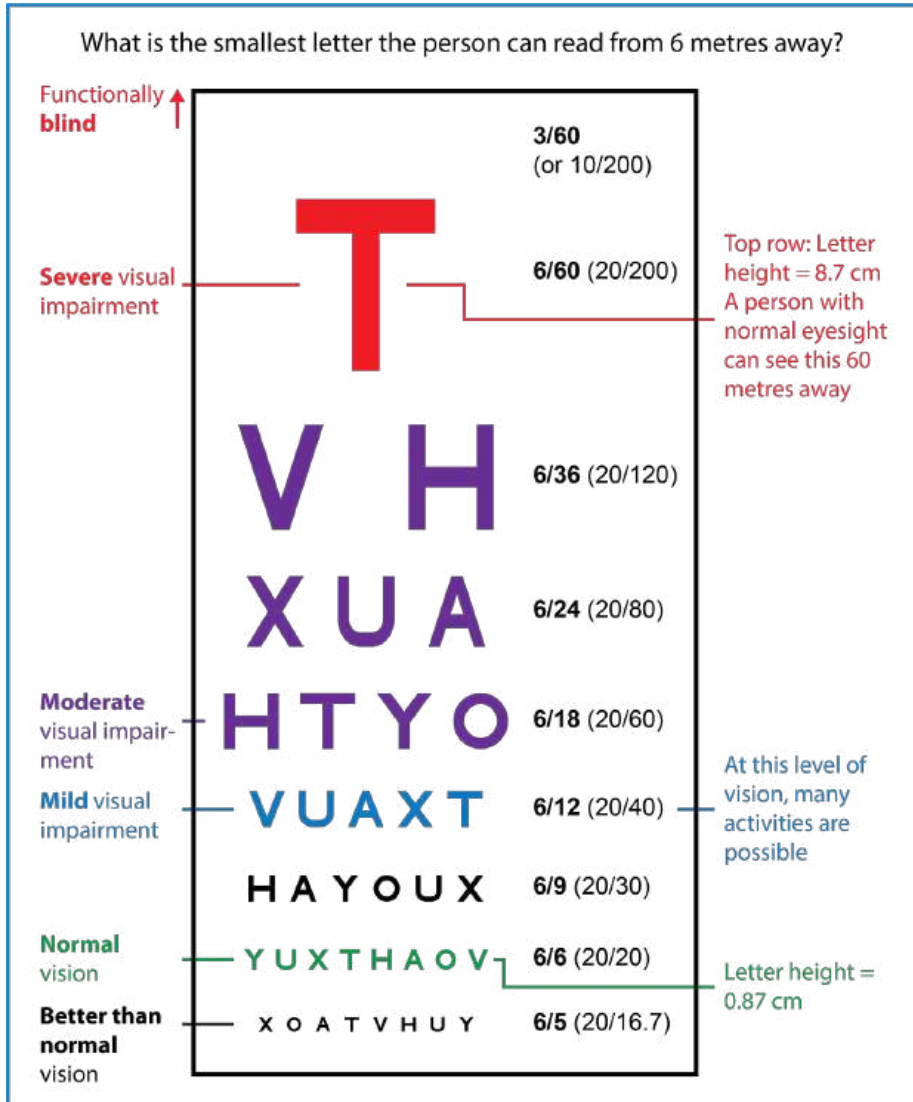

Levels of visual impairment as measured by a Snellen eye test chart. Important: eyesight tests should be done by a qualified professional. In a full-sized chart, the largest letter is 8.7 cm high.

Visual impairments have different causes, including injury, disease and congenital problems. Some children are born blind; other people lose their sight either gradually (because of disease) or suddenly (through injury). Learners who have lost their vision may still be able to remember what it was like to see, and may have been able to read. They are in a different situation to those who have been blind since birth or who lost their vision at an early age.

If you suspect a learner in your class is visually impaired (for example, if they squint at the board or hold the paper close to their eyes), make sure an optician tests their eyesight. Some types of visual impairment can be corrected using glasses.

Depending on their level of visual impairment, learners may find it better to use **braille** instead of, or as well as, alternatives such as **large-size print** or a **magnifier**. Learners who are expected to lose their sight because of a progressive disease should also learn braille. So too should those who support blind students: teachers, teaching support staff, social workers and parents.



# Part 1

## Teaching methods

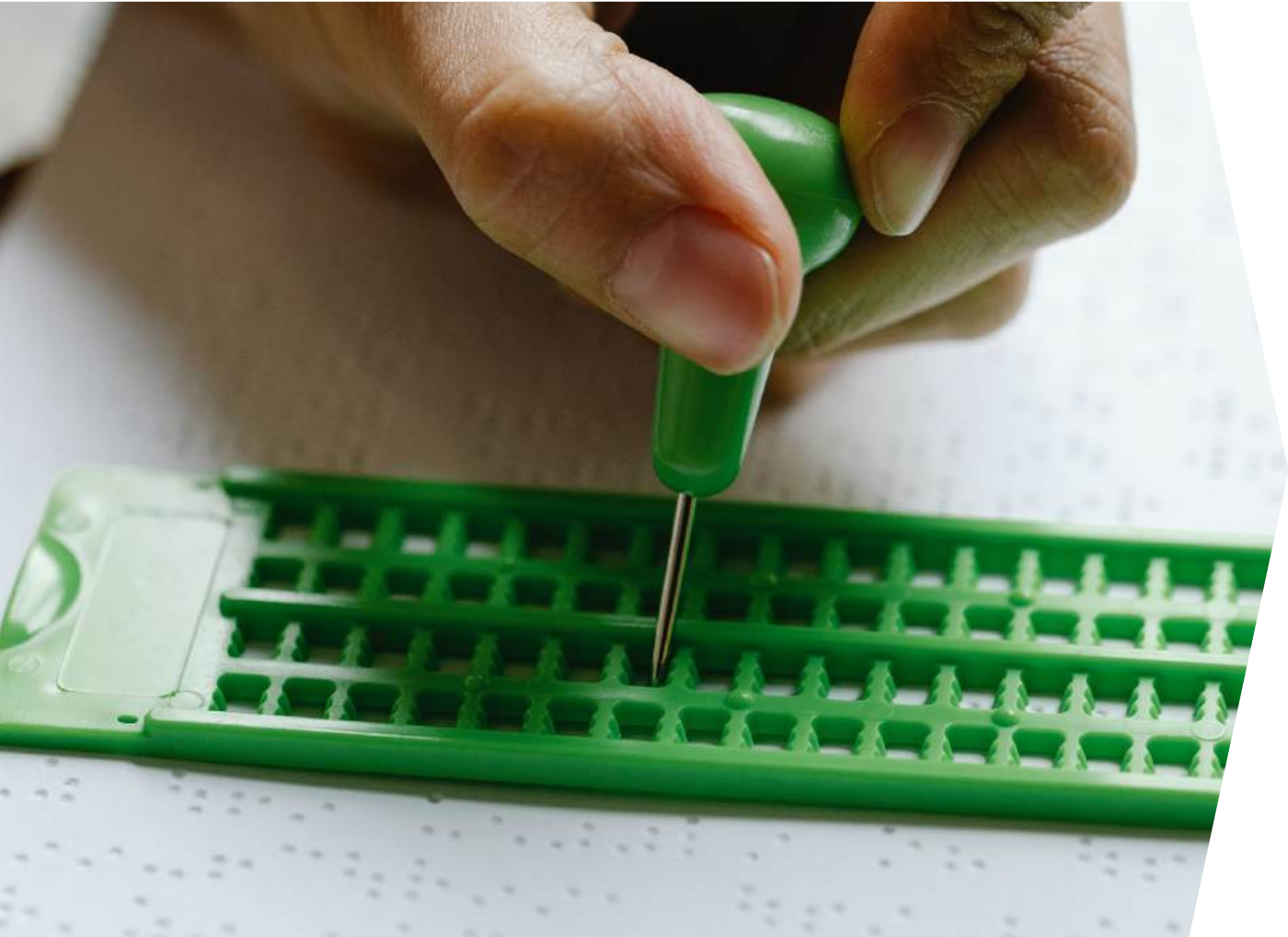

Part 1 describes how to teach maths to blind and visually impaired students. It covers the challenges faced by both learners and teachers, adaptations needed to the curriculum teaching techniques and materials, and how to work with other professionals to ensure that all students in the class, both sighted and visually impaired, learn mathematics to the best of their abilities.

### 1.1 Challenges faced by learners

#### **Lack of visual clues**

The mathematics teacher stands in front of the class, points to a drawing on the board, and says:

*"This figure here is a rhombus. It has four equal sides, and its opposite angles, here and here, are equal..."*

This description is very difficult to understand if you cannot see the drawing. Blind students cannot see the figure, the board, or the teacher's gestures. A student with low vision may be able to pick out the gestures and the board, but not the drawing. The description sounds a bit like the description of a square. "Why is it called a rhombus?" they wonder. "What is the difference between a square and a rhombus? Where is 'here'?"

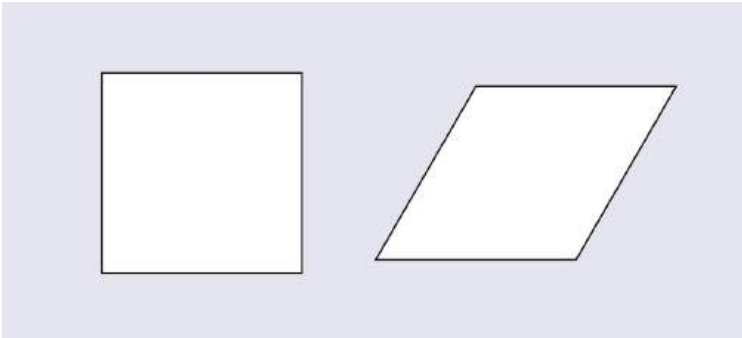

**Square or rhombus? The difference is obvious if a drawing is available.**

A tactile drawing (a drawing with raised lines that can be felt with the fingertips) of a rhombus would help a lot. The learner can then run their fingers over the drawing to feel that the sides are the same length and the opposite angles are indeed equal (and are not necessarily right angles). The verbal description still needs a little modification to help the blind or visually impaired student navigate it:

*"This figure is a rhombus. It has four sides that are equal in length. The opposite angles – at the top right and bottom left – are equal. The other two angles – at the top left and bottom right – are also equal."*

### Reliance on memory

An important activity in mathematics lessons is reading and calculating the value of an expression. The mathematics teacher writes this expression on the board:

$$23 + 14 - 8 =$$

The teacher says "twenty-three plus fourteen minus eight equals..."

A sighted student will reread this expression, or parts of it, a few times while calculating the result. They may write the numbers down and do the calculation on paper. Blind and visually impaired learners cannot do this. They cannot read what is written on the board, so have to rely on their memory, while at the same time performing the calculation in their heads. That is very challenging (try doing it with your eyes closed). They will probably not be able to keep up with their classmates.

The need to rely on memory is also why blind and visually impaired students make more errors when writing. Even if they have written an expression in braille (for example, using a braillewriter), it is difficult for them to reread it.

### Need for more time

Reading braille is generally more time-consuming than reading printed text because the student must read one braille character after the other in sequence. Blind and visually impaired students will probably need more time than their classmates to understand an exercise and come up with the answer.

This need for extra time can be a serious problem. The blind or visually impaired learners will miss out on work as the teacher moves the class on before they finish. It is also complicated to work together with their classmates because they work at a faster pace. This can make the blind or visually impaired learners feel very uncomfortable.

### Getting the big picture

It is not possible for blind students to get an overview of the content of a page at a glance (is this a description, a question or an equation? Is it a bar graph or a line graph?). With diagrams, the information (shapes, labels, instructions, questions) may be scattered across the page. Just finding all the bits of tactile information takes longer than with printed text.

### Need for supportive devices

The teacher says, "turn to page 53 and do exercise 1." A sighted learner can open the textbook on the right page, find the right exercise, grab a pencil and start answering straight away. Correcting a mistake means rubbing it out with an eraser and writing over it.

A blind student takes much longer to find the right page in the book and the location of exercise 1. They must read the exercise, then use special equipment – a braille or slate and stylus – to write the answer. They must feed special paper into the equipment, then laboriously punch out the braille character by character (or, with a slate and stylus, dot by dot). If they make a mistake, they have to go through a longer routine to correct it.

Braille is expensive pieces of equipment, and not every blind student (or school) has one. A slate and stylus are cheaper and more portable, but are slower to use.



Using a slate and stylus to write braille.

### Sequential channels

Sighted students can scan a page, a drawing or an equation to get the big picture, then focus in on the details. They can go back repeatedly to check details or to remind themselves of things they did not understand at first.

Blind learners have it much harder. They learn through two main channels: by feeling with their fingertips, and by listening. Both of these channels are sequential: they take in one piece of information, then another, then another, rather than several items at once. It is impossible for a blind student to scan a page, and it is difficult to stop and go back to check what they have already covered. Learners with low vision also find it difficult to scan what is on a page, and may be able to see only a part of a drawing or an equation at a time. A wrong answer may be because of a misreading (such as misinterpreting or skipping a braille sign) rather than a lack of understanding.

### Mismatch between spoken and tactile versions

When an expression is spoken aloud for sighted students, it often does not correspond with what a braille reader reads with their fingertips. For example, the fraction  $\frac{x+2}{x+3}$  is written in braille as  $[x + 2/x + 3]$ . The braille version is written on a single line and uses special characters to show the start and end of the fraction. The teacher focusing on a classroom full of sighted students is not likely to mention them.

**Extra things to learn** Because of the need for supportive devices, a blind or visually impaired student must learn more than their sighted peers. In addition to the subject of mathematics itself, they also have to learn how to read and write mathematical braille notation, tactile drawings and graphs; if they use a computer, they will have to learn how to understand the audio information from the screen reader program that reads out what is on the display.

## 1.2 Challenges faced by teachers

Maths teachers face various challenges when teaching blind or visually impaired students.

### Balancing needs

It is difficult at the best of times to balance the needs of all the learners in a class. That is particularly true if one or two learners are blind or visually impaired, especially in large classes.

### Special materials and equipment

Classrooms, equipment, teaching materials and curricula are all designed with the needs of sighted learners in mind. But blind and visually impaired students have additional needs. In particular, they need special learning materials and equipment. The equipment can be expensive, and preparing the materials can take a lot of time. The teacher needs to understand how the special learning materials and equipment affect the teaching and the students' learning. This is difficult and time-consuming.

### Teaching methods

Teaching methods such as "chalk and talk" (writing on the board while you explain something) do not work well for visually impaired and blind learners. They cannot see what you have written or what you are pointing at. Many teachers teach in the same way as they themselves were taught. All too often that means rote learning rather than stimulating understanding or creative problem-solving. Curricula are often prescriptive and highly restrictive. At the same time, learners

often have expectations on how they will be taught. It can be difficult to be creative and introduce new methods.

At the same time, approaches useful for blind and visually impaired students can also make learning easier and more fun for sighted learners. Examples in this manual include the abacus, algebra tiles, 3D shapes and nets.

### Textbooks and exercises

Printed materials for classroom use or homework need to be converted to a format that the learner can understand and use. That may mean converting them to braille, or enlarging them for readers with low vision. Diagrams and graphs need to be tactile (for blind and some visually impaired learners) or high-contrast (for learners with some vision). But adapting exercises (or designing new ones) takes effort and preparation time.

### Time

It typically takes blind and visually impaired learners longer to understand and do an exercise. You need to give them extra time for exercises and in tests. You can also reduce the number of exercises to make it possible for the learner to learn the concepts in the time available. But selecting which exercises are suitable requires preparation time.

### Assistance

Schools with learners who have special needs (such as blind or visually impaired pupils) should have support staff to help provide the special needs of these students. For mathematics this is particularly important, as this is a technical subject that requires special knowledge and skills to teach. Ideally, the school should have a dedicated **support maths teacher** to take on this role. This person should have both the maths background and the skills needed to teach learners who have special needs. Unfortunately this is rarely the case.

More likely, a school has one or more **teaching assistants** to help the regular classroom and subject-matter teachers. It may also have a resource room equipped with the special equipment and teaching materials required. This resource room is managed by a **resource-room teacher** (see the section on **Resource room** below).

It is the job of these support staff to provide whatever assistance is needed to ensure the special-needs learners can learn optimally. That may include preparing teaching materials and exercises, teaching basic skills such as braille that are necessary to learn subjects such as maths, and supporting the maths teacher in the classroom. But it is not normally the job of the resource-room teacher or teaching assistant to teach maths (and indeed, they may not have the knowledge and skills to do so). That is the job of a qualified maths teacher. See the section below on **Support maths teachers and teaching assistants** for more on their role.

One piece of general advice: when interacting with blind or visually impaired learners, view yourself also as a potential learner. They can show you new ways to obtain and respond to information. You will pick up new techniques that will make you a better teacher and help all the students in the class.

### 1.3 Expanded mathematics core curriculum

Blind and visually impaired students have the same academic goals as sighted students of equal cognitive ability. Where blind and visually impaired students are expected to follow the same core curriculum as their sighted peers, they will need specific instruction in certain areas. This extra set of skills is known as the “expanded core curriculum”.

The expanded core curriculum for mathematics includes (for blind students) learning how to read mathematical expressions in braille. For students with low vision, it includes using a magnification device to explore a graph. The expanded curriculum will be adapted for each student, depending among other things on the student’s cognitive abilities and the severity of their visual impairment.

This extra instruction may be provided by different professionals, including the maths teacher and the resource-room teacher or teaching assistant. These professionals must agree on the content, planning and organization of the extra curriculum. Who does what depends on their knowledge and skills and the time they have available. A family member or a classmate may also give some support.

Before introducing a new subject or chapter, the maths teacher (in collaboration with other professionals in the school) must think about what extra support the student needs. Fill in a form for expanded mathematics core curriculum (**Table 1**) for each topic you will cover or each chapter in the maths textbook. This form will guide the teaching team throughout the school term. Use the form to note the most appropriate teaching techniques to use for each topic (see the next section).

#### More information

Cushman, C. Expanded core curriculum. An introduction to the Expanded Core Curriculum (ECC) for students who are blind or visually impaired. Paths to Literacy.

<https://www.pathstoliteracy.org/expanded-core-curriculum>

**Table 1. Empty form for expanded mathematics core curriculum**

Name of student	
Vision (delete not applicable)	Blind / visually impaired
Subject	
Responsible professional (delete not applicable)	Maths teacher / support teacher / teaching assistant / resource-room teacher
Start teaching subject in class	

**Preparation of materials**

Material	Action	Completed by	Responsible	Remarks

**Instruction of expanded curriculum**

Skills	Instructor	Materials	Schedule	Remarks

**Tests**

Date of test	Time needed for student to complete test	Test marked by	Date of marking test

**Evaluation**

Topic	Performance	Schedule

**Table 2. Example of complete form for expanded mathematics core curriculum**

Name of student	Henry A.
Vision (delete not applicable)	Blind / <del>visually impaired</del>
Subject	Linear equations (Chapter 3, textbook)
Responsible professional (delete not applicable)	Maths teacher / <del>support teacher / teaching assistant / resource room teacher</del>
Start teaching subject in class	19 April

**Preparation of materials**

Material	Action	Completed by	Responsible	Remarks
Exercises 3 and 6	Not accessible, adjust exercise	20 April	Maths teacher	
Exercise 4	Not accessible, remove exercise	20 April	Maths teacher	
Worksheet 5	Not accessible, remove worksheet	20 April	Maths teacher	
Test item 2	Not accessible, adjust item	2 May	Maths teacher	
Chapter 3	Transcribe to braille	25 April	Support teacher	With adjustments
Worksheets 1-10	Transcribe to braille	25 April	Support teacher	With adjustments
Final test	Transcribe to braille	10 May	Support teacher	With adjustments

**Instruction of expanded curriculum**

Skills	Instructor	Materials	Schedule	Remarks
Reading linear equations in braille	Support teacher	Linear equations in braille	19 and 21 April: 10 mins	Accurate reading and getting an overview
Writing (typing) linear equations in braille	Support teacher	Slate and stylus, paper	19 and 21 April: 10 mins	Accurate writing
Listening skills	Support teacher	Telephone	21 and 23 April: 10 mins	Equations need to be spoken aloud in correct mathematical language

**Tests**

Date of test	Time needed for student to complete test	Test marked by	Date of marking test
27 May	50 minutes	Maths AND support teacher	29 May

**Evaluation**

Topic	Performance	Schedule
Linear equations	57/100	Has difficulty with binomials



## 1.4 Teaching techniques

This section describes how to adapt your teaching techniques to cater for the blind or visually impaired students in your class.

### Give verbal support

The student cannot see, or may misinterpret, gestures and facial expressions. So you need to give clear verbal instructions, especially for what you write or draw on the board.

- Don't stand with your back to the students while verbalizing, as you will not be heard properly.
- Be detailed in the directions you give, and avoid using terms that will mean nothing to the blind or visually impaired student, such as "there", "here", or "this". Give specific descriptions instead, and teach the sighted classmates also to formulate in this way.

No	Yes
"Over there"	"At the top right corner"
"Here"	"The centre of the circle"
"This"	"The first term in the equation, $x^2$ "

- Spell out each new technical term so all the students (and not just the blind and visually impaired) know how to spell it correctly.

"The hypotenuse – that's H-Y-P-O-T-E-N-U-S-E. The hypotenuse is the longest side of a right-angled triangle."

- Make sure that you, and the learners, use the correct mathematical vocabulary. This will benefit all students.

### Provide a copy of notes

It can be challenge for blind and visually impaired students to take notes during the lesson. If so, you can give them a copy of the notes beforehand, depending on the student either in standard or enlarged print, or in braille. If the student uses a computer, you can email these notes to them. If there are drawings that are critical to the text, give the blind student a verbal description of the drawing.

### Use multiple ways to provide content

Use several different methods of providing content to the student: visual, verbal and tactile. This manual has many examples of how to do this. Always supplement visual or tactile material with clear verbal explanations.

### Provide tactile teaching materials

Provide tactile versions of 2-dimensional drawings and graphs. Provide 3D-models such as pyramids and cubes instead of relying on 2D-drawings of these 3-dimensional figures. Use the expanded mathematics core curriculum form (**Table 1**) to plan what materials you will need in which lesson. The student may need a braille version of a printed book or equipment such as a tactile ruler

or protractor. It may be necessary to prepare teaching materials and tactile exercise sheets beforehand. Try to find ways for the sighted and blind learners to use the same equipment. Sometimes, though, it is better to look for alternatives for blind students. Each device has its strengths and weaknesses: one device may promote collaboration with sighted students but be of limited use for learning maths. Another device may promote maths learning by the blind student but can hinder collaboration with a sighted classmate. Weigh up what is most important for each situation.

### **Make audio recordings**

To help blind and visually impaired students understand your classroom instruction, you can make recordings to introduce or summarize the lesson. You can also share these recordings with the sighted students.

### **Offer multiple ways for students to express themselves**

Encourage students to use various ways of expressing what they want to say: in writing, speaking, or gesturing. In general, blind and visual impaired students need more time to complete a mathematical task. It may be helpful to allow them to do at least part of the task orally.

### **Lesson planning**

Most lessons should have a fixed, predictable structure. This allows the blind or visually impaired student to anticipate what is expected of them, and allows them to work independently sooner. Plan each lesson carefully to find ways for the blind student to participate fully.

When giving instructions for an activity, first make sure the sighted students understand what to do. Then give individual attention to the blind student, before going on to supervise the sighted children. Alternatively, the support teacher can make sure the blind student has understood what to do.

### **One-on-one guidance**

Blind and visually impaired students may need more one-on-one guidance than their sighted classmates. The support teacher can be very helpful in providing this.

### **Pre-teach and post-teach**

The maths support teacher can go over the material with the blind and visually impaired students before the lesson to help them understand the concepts and to familiarize them with the teaching material. After the lessons, the support teacher can make sure the students have understood the material and provide assistance with the homework.

### **Additional time**

Exercises and homework take more time for blind and visually impaired students. Give them breaks to reduce fatigue. They also need about 100% more time to complete a maths test or exam. This can be shortened if all or part of the test or exam is taken orally.

But do not give these students too much time: they (along with sighted students) need to be challenged to work quickly and efficiently.

## 1.5 Where to teach maths to blind students?

In schools where the blind students are in the same classes as sighted students, they should do as many activities as possible together with their sighted peers. This includes mathematics. But some aspects of mathematics require skills that they will have to learn in addition. Examples are mathematical notation in braille and the use of the Taylor frame. It is best to teach them such subjects separately from the rest of the class. This can be done by taking them out of the classroom at suitable times and giving them special lessons with the support teacher.



A Taylor frame is used to perform arithmetical calculations. It is a pegboard with star-shaped holes, into which the user can insert pegs in any one of eight different orientations. See the section on **Taylor frame** in **Part 2** for details.

## 1.6 Classroom management

### Seating

All students in the class should have their own regular places in the classroom, with the items they need within easy reach. This is especially true for blind students. Smaller groups are better for blind learners.

Seat the blind students in the middle towards the front. For visually impaired students, ensure the lights come from behind or the side.

Place a blind or visually impaired student next to a sighted classmate who can help with, for example, exploring a (tactile) graph.

### Noise can be very disturbing for the blind student

They need quiet so they can hear and make sense of what is happening in the classroom. At the same time, a Perkins braille (used by blind students to take notes and write exercises) can be noisy and distract other children from their work.

### Student involvement

Involve the blind learner fully in classroom activities. For example, get them to respond to questions, take part in group work, and do measurements and calculations, along with their sighted peers.

### Student cooperation

Get sighted and blind students to cooperate with each other wherever possible. With the right equipment and approach, blind students can engage on an equal basis with sighted children. The sighted students should not perform tasks for the blind student: make sure that everyone takes their turn.

Help sighted students relate to the blind child. For example, remind them to say who they are, and get the blind student to ask. Tell the blind student what their classmates are doing and help them interact with each other. Encourage the classmates to include the blind student in their activities and to verbalize their gestures. For example, have the sighted classmate say that they are pointing to the x-axis.

Look for ways for students who are blind or visually impaired to link up with what sighted students do. Many of the ideas in this manual can also be used with sighted students. When choosing a calculator, for example, consider what type the sighted classmates use. Can you obtain a similar, accessible, model for the students who are visually impaired?

### **Display classroom rules**

It may be helpful if everyone in the class follows the same simple rules that help everyone learn mathematics. For example, give verbal support while making gestures.

### **Organization of materials**

The teaching assistant or resource-room teacher can help the blind and visual impaired students organize their materials by using checklists and containers to keep materials organized in desks. Give these students the possibility to put assistive devices (such as a braille) on an extra table. Put the equipment needed for maths in a corner of the classroom where the blind student can find it easily.

## **1.7**

### **Working with parents**

#### **Contact with parents**

Keep in contact with the parents of the blind student. Explain to them what their child is learning and what you are doing to help them learn.

Provide the parents with feedback on their learner's performance. Discuss problems with them and seek solutions. Discuss with them how they can help their child further.

#### **Braille**

Provide printed equivalents of the braille learning materials (text, exercises) that the learner takes home so the parents can help with homework.

Encourage the parents to learn braille so they can support their child at home. Provide them with learning materials if possible. Braille courses designed for sighted learners are available to buy or online.

## **1.8**

### **Adapting materials**

Students who are blind cannot use printed materials designed for sighted learners. (Many learners with low vision may be able to use them with a magnifier and suitable lighting.) The materials may need to be adapted in a suitable way, depending on the severity of the visual impairment, the student's cognitive ability, and the task to be done.

Possibilities include braille, large print, regular print with the use of optical devices, and audio recordings. Use the expanded mathematics core curriculum (**Table 1**) to note the appropriate adaptations for a particular student.

Not all drawings and graphs in a text are vital. For those that are important, you should provide a verbal explanation plus a tactile version.

See **Part 2** for how to adapt materials for blind or visually impaired learners.

### 1.9 Textbooks for braille students Useful for: Blind

If your school does not have maths textbooks in braille, here are some ways to make them available.

- Find out if a braille version of the book is available. Try contacting the publisher or your national organization for blind people.
- Find a service in your country that is able to convert it to braille. Ask your national organization for blind people (check the website of the World Blind Union for a list of national associations of the blind in your country). These services have specialized staff and software that can convert materials to braille quickly and accurately (see below). Many countries have signed the Treaty of Marrakesh, which makes it easier to produce and adapt material for blind and visually impaired people.
- Ask other schools in your area whether they have the book in braille form.
- Try to get an electronic copy of the textbook. Ask the publisher and explain why you need it. To avoid intellectual property concerns, assure them that you will not use the file for any other purpose, or share it with anyone else. Then convert it to braille notation using a software braille translator such as that produced by Duxbury Systems (see **More information**). Caution: this is a major job that requires considerable time and expertise in both braille and maths. It should not be the job of someone who is not sufficiently skilled in both. Always check the braille output for errors before using it.
- If only a hardcopy is available, retype the text in braille format. (This is an even bigger job!)
- Instead of converting a complete textbook to braille, consider converting only those parts that are vital, such as key explanations and exercises.
- If you have an electronic version in braille, and the student has a computer and braille display, then give the file to the student to read on the display.
- If no braille display is available, print the book on a braille embosser and give the student a hardcopy.
- If no computer and embosser is available, use a Perkins brailier to produce a hardcopy.
- If a different textbook is available in braille, consider teaching students who are blind separately from their sighted classmates (this may be possible with a support maths teacher). Try to convert the exercises from the main textbook into braille so the students can do them in class alongside their sighted classmates.
- Consider using a general textbook and then converting it to braille. See **More information** for sources of free maths textbooks.

It is not usually the task of the maths teacher to convert textbooks to braille. Depending on the situation, this may be the task of the support teacher.

### 1.9.1

#### Braille notation of mathematical expressions

##### Useful for: Blind

In converting textbooks to braille, special attention is needed to transcribe the mathematical expressions and formulas correctly. Braille has a lot of detailed rules for mathematics.

See **Part 2: Braille** for details.

Some organizations for blind and visually impaired people have software that can automatically convert mathematical expressions into the correct braille notation. If you can get a digital version of the textbook, find out if an organization in your country can do the conversion for you. This is much easier and quicker than doing it yourself, and there will be fewer errors.

#### More information

##### Free maths textbooks

American Institute of Mathematics. Approved textbooks. <https://aimath.org/textbooks/approved-textbooks/>

PreTeXt. <https://pretextbook.org/catalog.html>

##### Free online braille translators

Caution: these can transcribe simple expressions but do not allow the input of mathematical symbols such as powers and roots. Always check the braille output carefully before using it.

BrailleTranslator.org. Free online Grade 2 braille translator. <https://www.brailletranslator.org/>

Branah.com. Braille translator. <https://www.branah.com/braille-translator>

Maths is Fun. Braille translator. <https://www.mathsisfun.com/braille-translation.html>

##### Organizations and treaties

Wikipedia: Marrakesh VIP Treaty. [https://en.wikipedia.org/wiki/Marrakesh\\_VIP\\_Treaty](https://en.wikipedia.org/wiki/Marrakesh_VIP_Treaty)

WIPO. The Marrakesh Treaty. [https://www.wipo.int/marrakesh\\_treaty/en/](https://www.wipo.int/marrakesh_treaty/en/)

World Blind Union. <https://worldblindunion.org/>

##### Software braille translators

American Foundation for the Blind. Braille Translators. <https://www.afb.org/blindness-and-low-vision/using-technology/assistive-technology-products/braille-translators>

Duxbury Systems. <https://www.duxburysystems.com/>

RNIB. Transcribing text to braille. <https://www.rnib.org.uk/braille-and-other-tactile-codes-portal-writing-and-producing-braille/transcribing-text-braille>

## 1.10

### Support maths teachers and teaching assistants

Useful for: Blind, Low vision, Sighted

It is unrealistic to expect a regular maths teacher to have all the skills and knowledge needed to teach mathematics to students who are blind or visually impaired. This requires skills in braille and using special equipment. The regular maths teacher with a full classroom and timetable is also unlikely to have the time needed to devote to individual students who are blind or visually impaired. The solution is to appoint a support maths teacher or teaching assistant to assist the maths teacher with learners who have visual impairments.

A **support maths teacher** is someone who has both the maths background and the skills needed to teach learners with visual impairments. This person could provide maths support to all the students with visual impairment in the school, or could perhaps serve several schools within easy reach of each other.

A **teaching assistant** is someone who provides support to teachers of various subjects, not just maths. This person does not have the background to teach the content of lessons (especially at the more advanced levels), but can still provide vital support to the subject-matter teachers. A school that has one or more blind pupils should have at least one teaching assistant to ensure that these children have the same opportunities to learn as sighted children.

#### 1.10.1

##### Roles

Ideally, both the support maths teacher and the teaching assistant should be able to read and write braille and to use the equipment required by learners who are blind or visually impaired. However, reality is often less than ideal. The roles played by the support maths teacher and the teaching assistant will depend on the skills of these individuals. Each school will have to find its own staffing solution within the staffing and budgetary constraints it faces.

Below are some guidelines if you are a support maths teacher or teaching assistant (note that the specific tasks and responsibilities will depend on the situation and your own skills).

The support maths teacher is responsible for all the children in the classroom, including the blind and visually impaired learners. Your job is to support the teacher and help pupils learn and become independent adults. Remember, the emphasis is always on helping them learn to do things themselves, and not doing things for them.

Your job consists of four main tasks:

- Behind-the-scenes work
- Direct assistance
- Facilitating
- Enrichment.

## 1.10.2

**Behind the scenes**

Ideally, sighted children are automatically given a suitable learning environment from Day 1: they are given the books, equipment and working space they need. (Unfortunately in some countries this is not yet the case.) You should give a blind or visually impaired learner the equivalent environment that will help them learn to the best of their ability.

- Set up the desk and the surrounding area so the pupil can use them independently. They need to know where books, papers other items will be, where to put completed work. The items should always be in the same place and within their easy reach. As the pupil moves between classrooms, make sure the equipment and materials are available in the right place.
- The desk should be for the use of the blind or visually impaired learner, not for you. If you have a desk in the room, it should not be next to theirs. That way, the learner's focus is on the teacher, not on you.
- Watch the learner's progress and identify tasks that they can do by themselves.
- Plan with the maths teacher what to do, and prepare materials and equipment as needed. This includes obtaining (or making) braille versions of texts and exercises.
- Adapt materials for maths lessons. Sometimes this is easy; sometimes it will require a lot of imagination and creativity. Sometimes it may be necessary to provide the blind or visually impaired learner something very different from what the sighted students are using. Coordinate with the teacher.

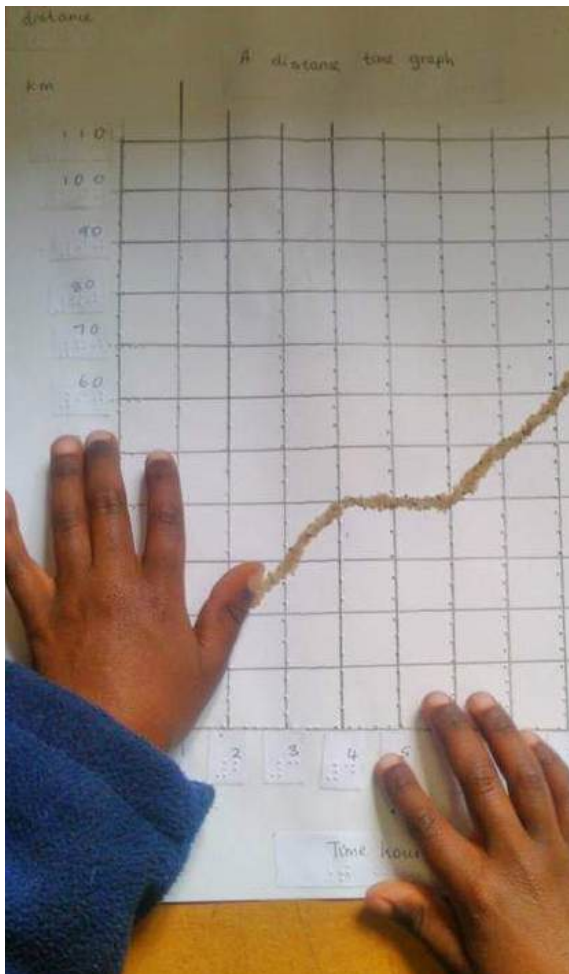

Preparing tactile versions of the teaching materials used in class can be time-consuming. It is important to develop the skills to produce them quickly and efficiently.



- Obtain materials that the learner will need for their lessons.
- Maintain the resource room and help pupils that use it.
- Advise and help maths teachers to adapt lessons to accommodate blind and visually impaired learners.
- Many braille books omit diagrams, maps, etc. Check them and provide alternatives if needed.
- If braille worksheets are used for homework, provide a print copy for the parents.
- Transcribe the blind pupil's work by writing in ink above each braille line. The maths teacher can then mark the work along with the rest of the learners' papers. Label items that are in braille with printed letters so the teacher and parents know what they are.

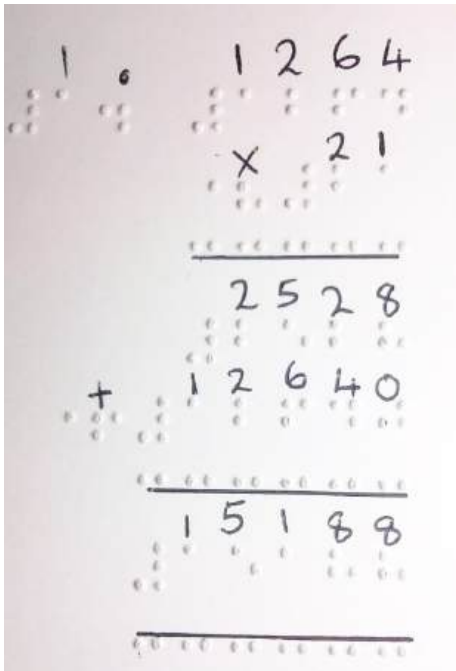

Transcribe what the child has written in braille. Note that the child has made two mistakes: multiplying by 12 (not 21), and adding the two intermediate figures incorrectly. It is the maths teacher's job to mark these as errors.

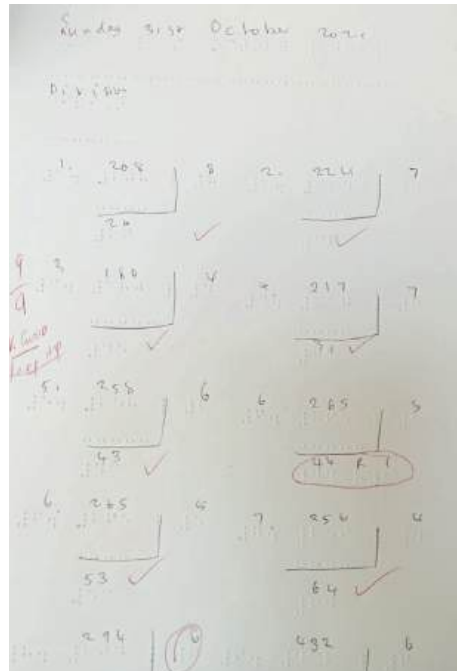

The support maths teacher transcribes the braille so the maths teacher can mark the learner's work. Use different colours so the transcription and corrections are easy for parents to distinguish.

- If the school has a braille translation program and embosser, you can produce many items in braille: worksheets, tests, announcements, etc. You can also print out the maths teacher's comments and corrections. If you have only a Perkins brailier, you will be able to produce much less braille material, so the teacher will have to choose what to give priority to. You can use tactile materials such as tactile glue or waxed thread to put the teacher's marking in a form the pupil can read.

### 1.10.3

#### Direct assistance

- Pre-teach (or post-teach) topics that the blind or visually impaired student is likely to find difficult during the regular class. For maths, it may be necessary to allocate 20 minutes a day to do this in a one-to-one setting for a blind student (probably less for a student who is visually impaired). The aim is for the student to participate in and profit from the regular lessons in the classroom.

- Teach topics that the blind or visually impaired student must learn but sighted children do not. These include reading and writing braille and working with tactile equipment such as a Taylor frame.
- Help the learner plan their homework, and teach them to ask for support when they need it.
- Help the pupil become as independent as possible. Do not do things for them. Instead, find ways for them to learn how to do things by themselves – for example finding the right book and navigating to the right page.

### 1.10.4

#### Facilitating

Facilitating means helping the blind or visually impaired learner to do things competently.

- Encourage the learner to explore and learn. Guide them to make discoveries.
- Verbalize what materials and equipment there are and which ones to use. Help them become familiar with the materials and equipment and how to use them.
- Give cues rather than help. Step back and allow the learner to do things themselves. A blind pupil will need more time than a sighted child.
- Read text to the learner, either directly or as a recording.
- Help the learner with specific tasks: using unfamiliar equipment such as a cube frame or calculator, or learning how to use a computer or a new piece of software.



The support teacher or teaching assistant should be able to read and write braille so they can produce teaching materials and help the learners.

### 1.10.5

#### Enrichment

This means enriching the blind or visually impaired pupil's educational experience to deepen their understanding and appreciation.

- Help the pupil become aware of the maths-related written and printed items around them, such as posters, bulletin boards, announcements, and pupils' work on the classroom walls. Add braille labels to these items. Make the pupil aware that this information exists, and help them learn how to discover it by themselves.
- Provide verbal descriptions of classroom activities, visual presentations and videos.

#### More information

Castellano, C. 1996. The blind child in the regular elementary classroom. *Future Reflections* 15 (3). <https://nfb.org//sites/default/files/images/nfb/publications/fr/fr15/issue3/f150302.html>

## 1.11

### Resource room

Useful for: Blind, Low vision

The school should have a resource room with the space, equipment and materials needed for teaching blind and visually impaired children.

Depending on the situation, this room may perform various functions.

- Teaching blind or visually impaired pupils certain subjects separately – for skills such as reading and writing mathematical expressions in braille, and using maths equipment designed for learners who are blind or visually impaired.
- Independent learning by the pupils.
- Storage of equipment and materials.
- Preparation of teaching and learning materials.

#### 1.11.1

##### Resource-room teacher

A teacher should be appointed to be responsible for the resource room. Depending on the situation, this may be a full-time job or it may be combined with other tasks (such as teaching assistant or support maths teacher). This person's job is to:

- Provide additional instruction for blind and visually impaired students. This normally means instruction in the additional skills the student needs to understand a subject (such as how to use a braille or a magnifier), and not instruction in the subject (e.g., maths) itself.
- Manage the resource room and the materials and equipment in it.
- Prepare teaching materials (such as braille versions of exercises or tactile diagrams).

#### 1.11.2

##### Workspace

The resource room may provide a workspace for blind or visually impaired learners to have separate lessons or to learn independently.

- Desks and chairs set up for teaching and independent work.
- A computer with a refreshable tactile display, Perkins braille or slate and stylus.
- Learning equipment, materials and consumables within easy reach.

#### 1.11.3

##### Storage space

Shelves or cupboards to store equipment and materials. Braille materials should be stored upright to prevent the embossed dots from being squashed. They should not be squeezed into shelves for the same reason.

Certain equipment and materials, such as textbooks and reading materials, may be lent out to the blind or visually impaired pupils and returned when they are no longer needed.

Other equipment and materials should be taken to the classroom by the teacher or teaching assistant as required, and then returned to the resource room.

The storage space in the resource room should be kept organized, with items in the correct places. Shelves, cupboards and boxes should have printed and braille labels to show what they contain.

### 1.11.4

#### Teaching and learning materials

These may include the following. See **Part 2 on Equipment and teaching materials** for more.

- Braille and large-print versions of textbooks and exercises.
- Braille reading and reference materials (these can also be kept in the school library).
- A manual of the mathematical braille notation used.
- Tactile versions of teaching materials such as diagrams, graphs and maps.
- Three-dimensional equivalents of items presented to sighted children as two-dimensional pictures: small objects, models, shapes.
- Geometrical shapes, building blocks, Lego bricks, magnetic manipulatives, etc.

### 1.11.5

#### Equipment

Some of this equipment is for use by the teacher; others are for the learners to use. For student use, several items of equipment may be needed.

- Computer with braille translation software, screen reader, braille display
- Embosser for creating tactile materials, heat lamp for swell paper
- Perkins braille
- Slate and stylus
- Taylor frame
- Abacus
- Geoboard (board with a grid of holes or pins)
- Calculator
- Magnifier
- Tactile rulers, tape measures, protractors and set squares
- Scissors, knives, marker pens, etc.

### 1.11.6

#### Consumables

- Braille paper, swell paper
- Waxed sticks (for graphs and diagrams)
- Tactile glue and paint (for graphs and diagrams)
- Paper, wire, rubber bands, plasticine or Play-Doh, etc. to make shapes and objects
- Etc.

## Part 2

### Equipment and teaching materials

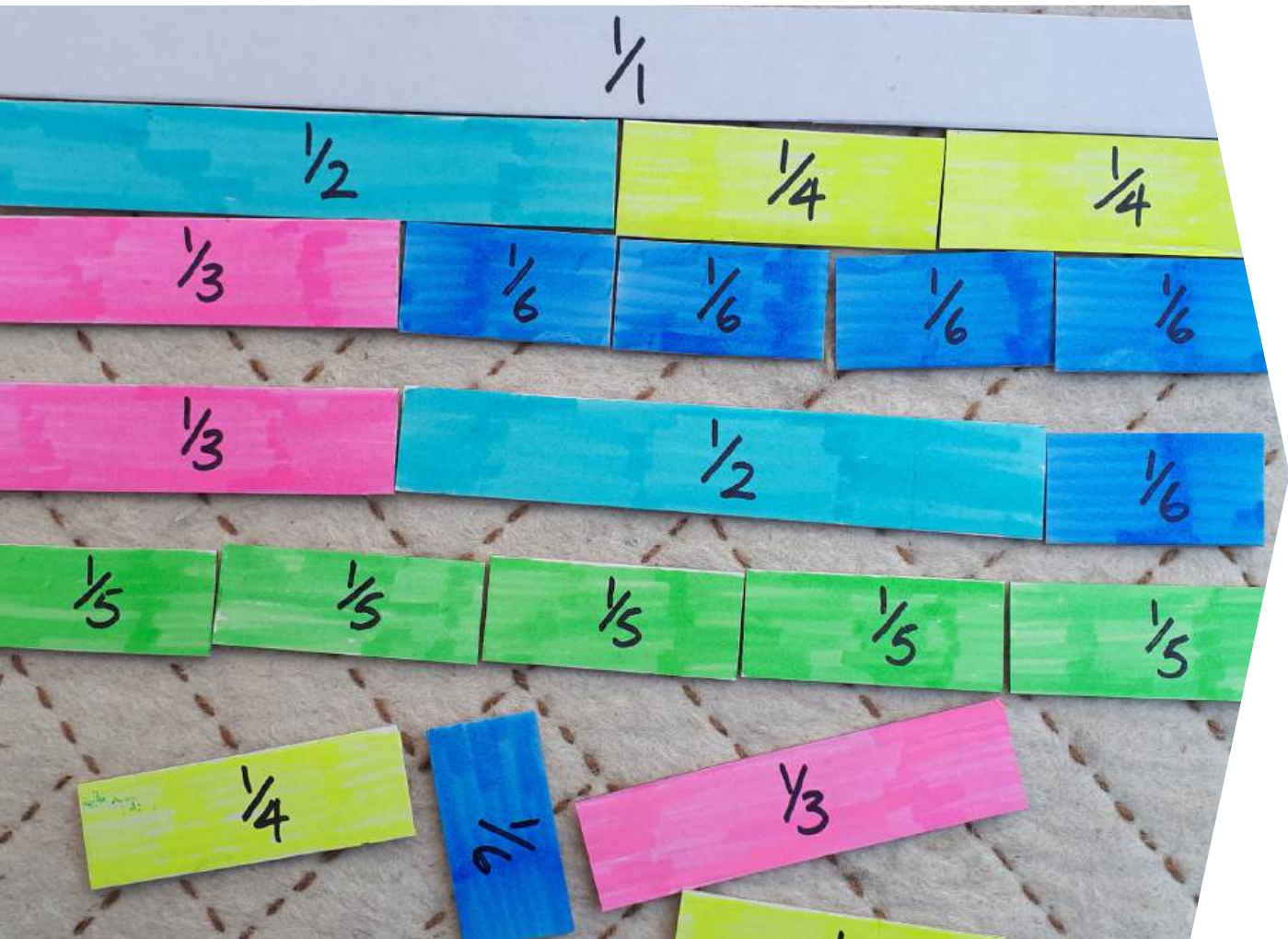

Part 2 focuses on the various types of equipment, teaching materials and techniques you can use to teach mathematics to blind and visually impaired learners.

These materials range from the simple and free to the complex and costly. You can use simple, everyday items to illustrate solid shape: tin cans (cylinders), balls (spheres), and boxes (cuboids). These are useful also for sighted students. Some calculators have a large, high-contrast display that both sighted students and those with some vision can use.

You may be able to adapt some items for blind or visually impaired students. For example, you can add tactile features to protractors and rulers so these students can use them.

Some items are useful only for blind or visually impaired students. Examples are tactile graphs, magnifiers, Taylor frames, brailers, and materials in braille.

Special computer software exists that makes it possible for blind and visually impaired students to learn and use programs such as spreadsheets.

## 2.1

### Where to get equipment and teaching materials

Many of the items described in this manual are everyday objects that can be bought in a toy shop, stationers, grocery or hardware store. Some can be made from readily available objects such as beads, string, card or plastic sheets.

For specialist items such as brailers, cube frames and talking calculators, check:

- Shops in your country that specialize in items for the blind or people with disabilities.
- Your national organization for blind people, the government ministry responsible (normally the Ministry of Education), or other organizations in your country supporting the blind and visually impaired.
- The websites listed in each section of this manual.

Make sure that the vendor will ship items to your country, and that they will not get held up in customs.

## 2.2

### Alternative tools for teaching maths

Various tools can be used to teach mathematics. Each has its strengths and weaknesses (**Table 3**). Some items are very expensive, and the school must weigh up the benefits against the costs of acquisition and maintenance.

It is useful for blind learners to learn how to use a range of techniques that they may encounter during their lives. We suggest introducing **braille**, then the **cube frame**, and then the **Taylor frame** (if you decide to use this) in that order. If **calculators**, **smartphones** and **computers** are available, they should be introduced at an appropriate stage, depending on the age and ability of the learners and the subjects to be taught.

Where possible, learners who are blind or visually impaired should use the same or equivalent equipment to their sighted peers.

Different types of equipment have different strengths and weaknesses.

An **abacus** is a useful tool for arithmetic; it is cheap and portable, and can be used by both sighted and visually impaired students. It cannot be used to store the answers for later reference.

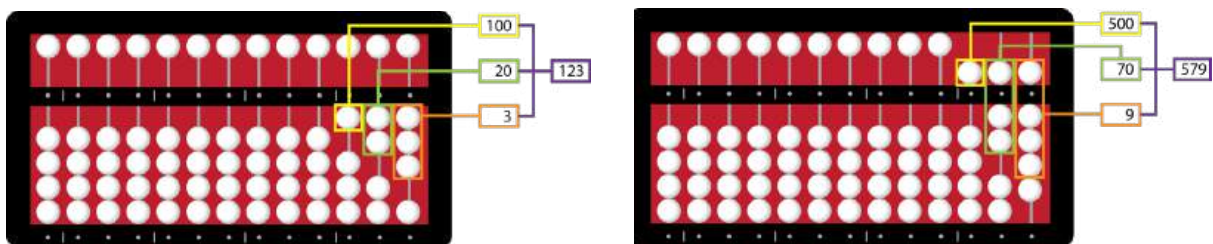

The calculation  $123 + 456 = 579$  on the Cranmer abacus. When moved to the central bar, the bottom beads represent the numbers 1-4; the top bead moved to the bar represents a 5

A **pocket slate and stylus** can be used to make permanent notes of calculations, but is difficult to use for vertical calculations.

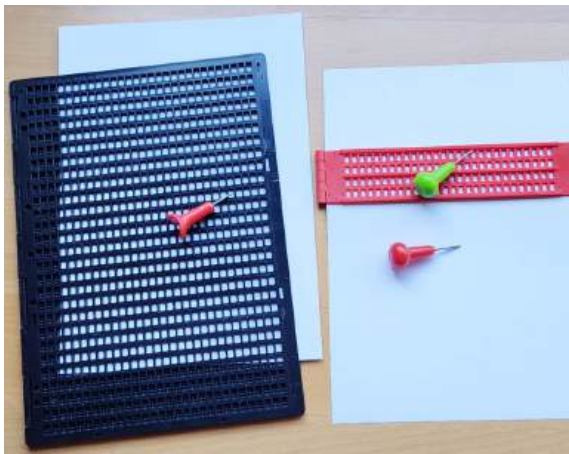

A full-sized (A4) slate (left) and a pocket (four line) slate (right), plus a selection of styluses.

Using a full-sized slate and stylus or **Perkins brailier**, it is possible to perform vertical calculations such as long arithmetic.

		123
		456 +
		—
		500
		70
		9 +
		—
		579

Long addition in braille using a slate and stylus or Perkins brailier

Most **braille notetakers** have only a single line of braille display, so they cannot be used to perform vertical calculations. It is necessary to compress the workings onto a single line.

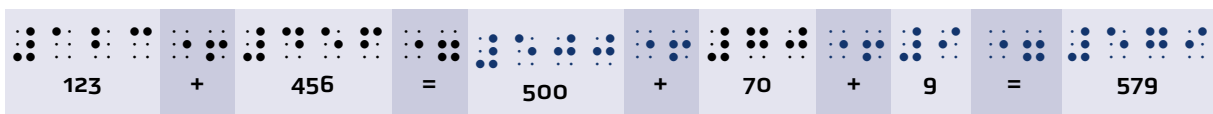

Compressing long addition into a single line for a braille display

See the section on **Braille** for more.

The **Taylor frame** and **cube frame** permit both vertical and horizontal calculations, but cannot be used to save the calculation.

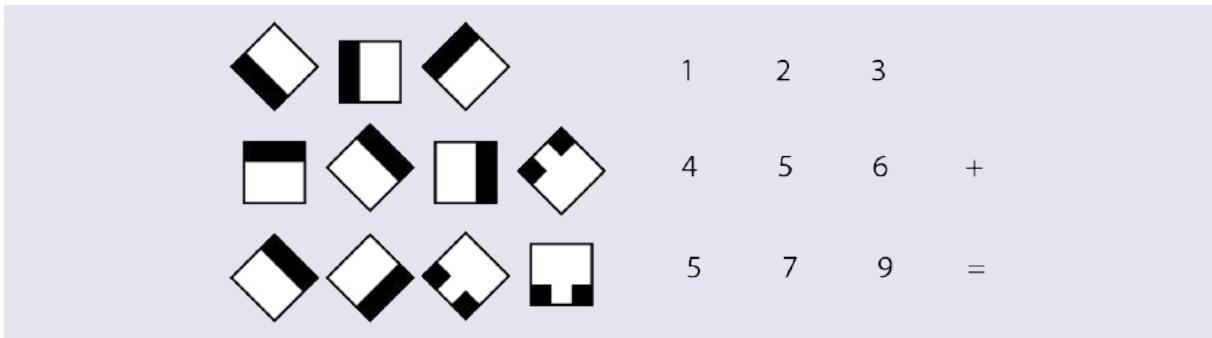
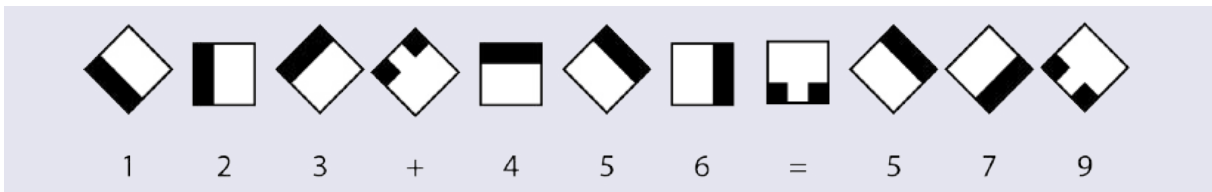

The equation  $123 + 456 = 579$  on a Taylor frame as horizontal and vertical calculations.

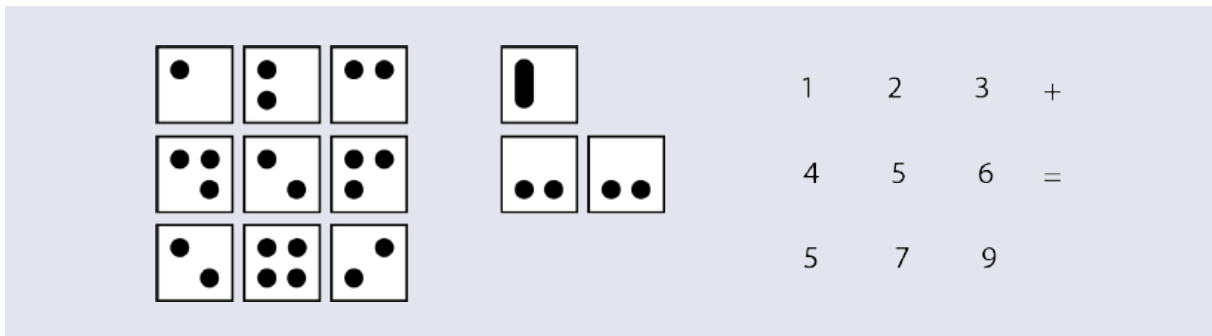
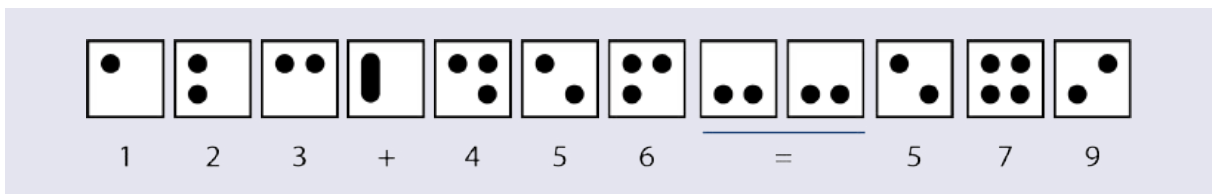

The same equation on a cube frame.

See the **sections on Taylor frame and Cube frame** or **cubarithm** for more.

The techniques in **Table 3** are not necessarily substitutes for one another. Someone using a braille, for example, must still do a lot of the calculations in their head: the braille is merely a help for making notes. A calculator or a computer using a spreadsheet program does the hard work for you.



Table 3. Characteristics of different equipment for learning and doing mathematics

	Page	Strengths	Drawbacks	Blind	Low vision	Sighted	Approx cost (USD)	Permanent record	Arithmetic	Algebra	Geometry	Trigonometry	Graphs	Tables
Slate and stylus	124	Cheap, portable	Slow, mirror writing	Y	N	N	15	Y	Y	Y	N	N	N	N
Geoboard	57	Cheap	Limited use	Y	Y	Y	20	N	N	N	Y	N	Y	N
Abacus	90	Cheap, portable	Limited use	Y	Y	Y	20	N	Y	N	N	N	N	N
Taylor frame	153	Versatile, vertical calculations possible	Hard to learn	Y	N	N	25	N	Y	Y	Y	N	Y	Y
Cube frame	148	Relates to braille, vertical calculations	Limited use	Y	N	N	80	N	Y	Y*	N	N	N	N
Computer + screen reader	111	Versatile	Requires electricity	Y	Y	Y	500	Y	Y	Y	Y/N**	Y	Y/N**	Y
Computer + magnified screen	110	Versatile, no extra software needed	Requires electricity	N	Y	Y	500	Y	Y	Y	Y	Y	Y	Y
Mechanical braille (e.g., Perkins)	125	Durable, versatile, vertical calculations	Noisy, requires paper, not portable	Y	N	N	800	Y	Y	Y	N	Y	N	Y
Electronic braille	126	Versatile, quiet, vertical calculations possible	Costly, requires paper	Y	N	N	2000	Y	Y	Y	N	Y	N	Y
Computer + screen reader + braille display	127	Versatile, quiet, can store inputs for later display and editing	Costly, single display line	Y	N	N	2500	N	Y	Y	N	Y	N	N
Simple calculator	94	Cheap	Requires batteries	N	Y	Y	10	N	Y	Y	N	N	N	N
Smartphone or tablet	98	Versatile	Requires charger	N	Y	Y	220	Y	Y	Y	Y	Y	Y	N
Scientific calculator	97	Versatile	Requires batteries	N	Y	Y	400	N	Y	Y	N	Y	Y	N
Talking calculator	97	Versatile	Requires batteries	Y	Y	Y	400	N	Y	Y	N	Y	Y	N

\* With additional algebra cubes

\*\* Yes for low vision, No for blind

## 2.3

### Text

#### Useful for: Low vision

To be readable by low-vision students, printed materials must be high-contrast and printed in a suitable font. Consider the following.

#### 2.3.1

##### Contrast

- Use the highest contrast possible. This means light (white or light yellow) letters on a dark (black or dark-coloured) background, or dark letters on light or white background.

Good	Bad
White letters on a dark background	Do not use colours that have low contrast
Dark letters on a light background	Do not use colours that have low contrast
Dark letters on a light background	

Aim for high contrast in printed materials. Use boldface to make the text stand out more.

- Advise the student to use a black pencil.
- Use bold-lined paper. This is available in many formats, including as graph paper. It has dark lines and enlarged spaces.
- The contrast is better if the lighting is good.

#### 2.3.2

##### Paper and printers

- Paper with a glossy finish can lessen readability because it causes glare. Use papers with a matte finish.
- For large print materials, you may need to use large-size paper (usually A3), and a large-format printer. If you do not have one, you can print two A4 sheets and tile them together to make a larger A3 sheet.
- To save toner, you can colour in diagrams by hand.

#### 2.3.3

##### Fonts

Use a sans serif font such as Verdana or Arial, rather than a serif font like Times New Roman. Avoid cursive script and *italics*.

Verdana and Arial are sans-serif fonts

Times New Roman is a serif font

*Don't use cursive script*

For learners with low vision, sans-serif fonts are easier to read than serif fonts.

<p>Antique Olive</p> <p>Arial</p> <p>Calibri</p> <p>Franklin Gothic Book</p> <p>Verdana</p>
---

Suitable fonts for large print (18 point).

- Lower-case letters are easier to read than CAPITAL LETTERS because their ascenders and descenders make them easier to distinguish.

### 2.3.4

#### Letter spacing

- Text with close letter-spacing often presents difficulties for readers who have low vision, especially those with central visual field defects. Use wide spacing where possible. You can add extra spaces or double spaces in expressions. A disadvantage is that these adjustments make the expression longer. That makes it harder to get an overview for a student who can see only part of the expression at any one time.
- Use a line spacing of at least 1.5.

closed spacing	normal spacing	expanded spacing	extra expanded spacing
----------------	----------------	------------------	------------------------

Differences in letter-spacing.

$3x+5x=9$ nospacebetween partsofequation	$3x + 5x = 9$ one space between parts	$3x + 5x = 9$ two spaces between parts
--	--	---

Use extra spaces to make expressions easier to read.

### 2.3.5

#### Large print

##### Useful for: Low vision

Large print is an option for presenting text to learners with low vision. Large print comes in two versions: printed, and on-screen.

Large print normally provides the same content as a standard print, but in larger font sizes. It is either printed on the same sized paper or on larger size pages. Both the text and diagrams are enlarged. This also gives the learner more space on worksheets in which to write their responses.

However, a higher magnification comes at the expense of the overview. A visually impaired student may be able to read the individual elements of an equation, but cannot get a view of the whole. Long equations may run over the end of the line; it may be impossible to get all the information on a single page. The extra reading effort is tiring. Therefore, students should be encouraged to use the smallest possible magnification that works for them. If you are making your own large-print materials, make the enlargement as small as possible. You can also give two graphs to a student: one in standard print (for the overview) and one in enlarged print (for accuracy). ...

Balance between accurate reading and getting an overview. The oval represents the visual field of the student. On the left, the student has an overview of the expression, but accurate reading may be difficult. On the right, the student can perceive only a part of the expression at one time.

Superscripts and subscripts are common in maths and the sciences. They are much smaller than the regular numbers and letters. To make them readable for students with low vision, you have to enlarge the whole expression. If a student needs a font size of 16 points for regular text, they will need a font size of 26 points for formulas, expressions and equations.

$3^2$	$\sum_{i=1}^n x_i$	$\frac{-b \pm \sqrt{b^2 - 4ac}}{2a}$
Font size 16 pt		
$3^2$	$\sum_{i=1}^n x_i$	$\frac{-b \pm \sqrt{b^2 - 4ac}}{2a}$
Font size 26 pt		

Extra enlargement for mathematical expressions with superscripts and subscripts.

Large print textbooks are not easy to come by in many countries. They are also bulky, expensive and difficult to store.

If you have the original text in a word processing file, you can enlarge the text in several ways:

- Select the text and enlarge the font size. In Microsoft Word, press Control + a to select all the text, then press Control + > several times to enlarge it.
- Modify the text styles to enlarge the font.

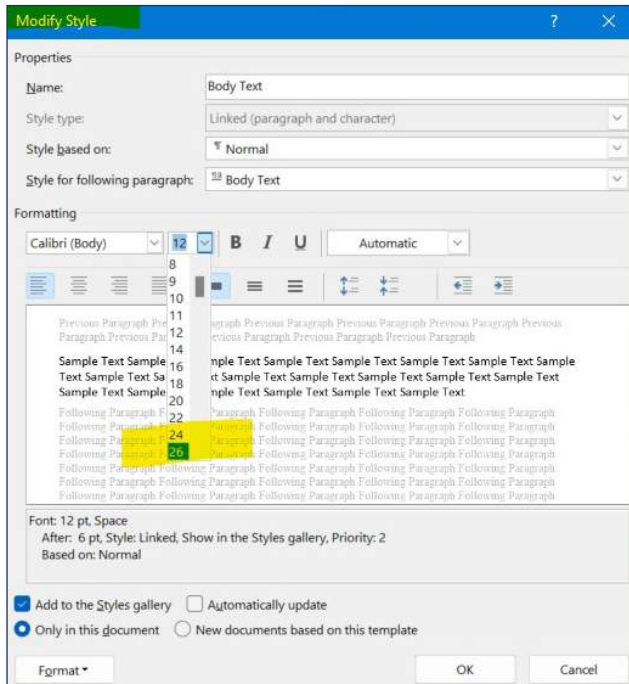

In Microsoft Word, you can modify the styles to enlarge the text.

Rather than retyping text and reformulating equations, you can make a screenshot and enlarge it.

### 2.3.6

#### Lighting

##### Useful for: Low vision, Sighted

Good lighting is important for low-vision learners as it improves both the light level and the contrast. Ensure that they are seated in the classroom so the light from the windows is behind them. Provide them with a table lamp if necessary to illuminate their work area and books.

### 2.3.7

#### Magnifiers

##### Useful for: Low vision

Low-vision students may be able to use regular textbooks and worksheets with the help of a magnifier. These come in many different forms, ranging from magnifying spectacles to hand-held or stand optical magnifiers, to electronic magnifiers. Some come with built-in lights to illuminate the text you are reading. The appropriate type of magnifier will depend on the learner's vision impairment and the use to which it is put. Hands-free magnifiers are useful where the learner needs both hands free while working.

For some students, the camera on a smartphone may provide enough magnification for many purposes.



An illuminated stand optical magnifier.



A handheld digital magnifier.

Magnifiers vary hugely in price. A simple optical magnifying glass costs a few dollars or euros. An electronic magnifier can cost hundreds of dollars.

#### More information

Paths to Literacy: Magnification. <https://www.pathstoliteracy.org/magnification>

American Foundation for the Blind. [Low vision optical devices. https://www.afb.org/node/16207/low-vision-optical-devices](https://www.afb.org/node/16207/low-vision-optical-devices)

Maxiaids: Magnifiers. <https://www.maxiaids.com/magnifiers>

Visionaware. What are low vision optical devices? <https://visionaware.org/everyday-living/helpful-products/overview-of-low-vision-devices/low-vision-optical-devices/>

### 2.3.8

#### Computers

You can enlarge the text on the computer screen using either the built-in Windows screen magnifier, or an add-on program such as a screen reader. See the section on **Computers** for details.

### 2.3.9

#### Highlighters

**Useful for: Low vision, Sighted**

You can use a highlighter to help students to focus on an expression or formula, or on a specific symbol. You can use different colours to help the student to distinguish between different items in the equation, or on different lines in a graph. Be consistent in your use of colours. For example, you could always use green for the unknown term to solve for.

$$3x^2 + 4 = y$$

$$x = 2$$

Using highlighters in an equation

You can also use a highlighters or stickers to indicate sections of text, such as theory, exercises, parts of a diagram, or tables.

### 2.3.10

#### Mathematical braille notation

##### Useful for: Blind

For blind students, the text (including any formulas, expressions and equations) needs to be transformed into braille. If this is not possible, consider an audio recording as an alternative. See the section on **Braille** for details on mathematical braille.

55 x 2 = 110



An equation in braille. Note that braille uses more characters (17, including spaces, compared to 12 for print) and takes up much more space.

## 2.4

### Counting and arithmetic tools

The information in this section is more suited to primary school students. We include it here because you may encounter students that need practice in this area.

These techniques are easy for parents to use with their children at home.

#### 2.4.1

##### Fingers

##### Useful for: Blind, Low vision, Sighted

Fingers are the simplest tool for counting and for doing sums up to 10. For blind children it is easiest to put their hands on the table so they can feel the fingers touching the surface.

Ask the learner to show you 10 fingers, then different numbers, such as 8, 3 and 1.

Teach the child how to add on their fingers: start with 3 fingers, then add 3 more to make 6 in all.

Or to subtract: start with 8 fingers, and take away 4.



10 minus 2 equals 8.

### 2.4.2

#### Objects

Useful for: **Blind, Low vision, Sighted**

A set of small, identical objects such as beans, pebbles or buttons can be used for counting. Put them in a bowl and get the child to count them into another bowl.



Small objects such as buttons, dried seeds or beans make good counters.

### 2.4.3

#### Bead strings

Useful for: **Blind, Low vision, Sighted**

Learners can use a bead string to count and do sums. The simplest bead strings have 10 beads: five of one shape and five of another shape. The learner counts and does arithmetic by moving beads along the string.

More advanced bead strings can have 20 or 100 beads. The learner can mark their place in the string with a clothes-peg.

The 100-bead string can be used for addition, subtraction, multiplication up to 100, and for division.

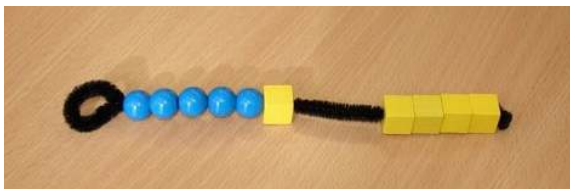

A bead string with 10 beads: 5 round and 5 square. The bead is set to show the number 6. The loop always goes on the learner's left.



A bead string with 20 beads, in 4 groups of 5.

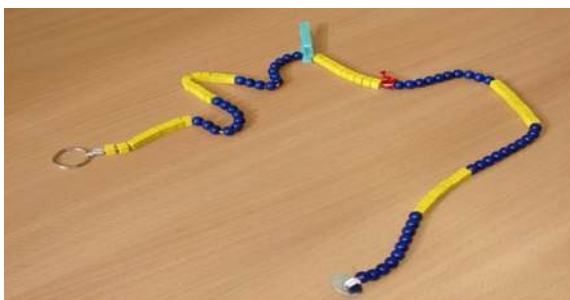

A 100-bead string, with 10 groups of 10 beads. The red marker shows 50. The peg is used to show the current number (here: 40).



#### 2.4.4

##### Bead board

**Useful for: Blind, Low vision, Sighted**

A bead board is a series of 100 beads strung on a rigid wire and fixed to a baseboard. Unlike the bead string, the beads cannot be moved: they are fixed in place by a series of screw eyes or woodworking staples that mark the 10s. Small upholstery nails mark the 5s. Two larger nails mark the 50.



A bead board. The beads are strung on a rigid wire fixed to the baseboard. They cannot be moved. Tactile marks show the 5s, 10s and 50.

Instead of counting and doing sums by moving beads, the learner points to the beads with their finger. The bead board can be used for arithmetic and to explain percentages. By setting the zero point in the middle, it can be used for both positive and negative numbers.

#### 2.4.5

##### Number board

**Useful for: Blind, Low vision, Sighted**

The number board is like a board board but without beads. Screw eyes (or staples) and upholstery nails are used to mark 5s, 10s and 50. You can make it the same length as the bead board to help the learner make the transition from counting beads to an abstract number line.



A bead board and a number line. The number line has tactile markings to show 5s, 10s and 50.

By setting the rightmost end of the number board to equal 1,000 (or 1 million) instead of 100, the board can be used to explain larger numbers.

#### 2.4.6

##### Number line

**Useful for: Blind, Low vision, Sighted**

A number line is the tactile equivalent of the number board, made by embossing paper or a plastic sheet.

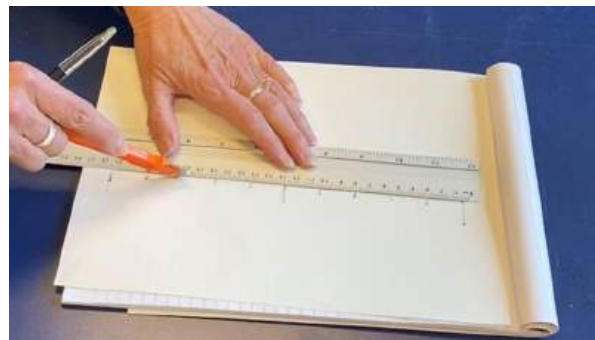
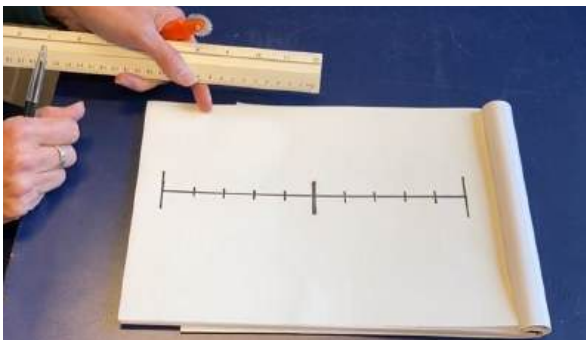

Embossing a tactile number line on paper using a spur wheel.

### 2.4.7

#### Braille number cards

Useful for: **Blind**

Braille number cards are useful for teaching the braille numbers. They can be used as flashcards to help learners recognize the numbers or to put them in the correct order. They can also be used for simple sums. You can make the number cards from a sheet of plastic, card or thick paper.

See the section on **Braille** for more information.



Braille numbers on cards: green: up to 10; red: up to 100. The holes are for orientation.

### 2.4.8

#### Braille number board

Useful for: **Blind, Low vision, Sighted**

A braille number board combines the idea of the number board with the braille numbers. It has a series of notches for each number from 1 to 20, each one marked with the number in braille.

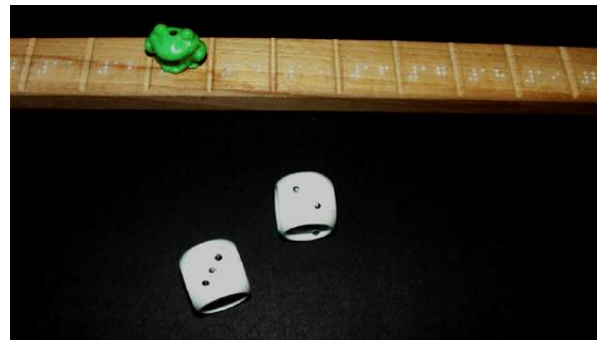
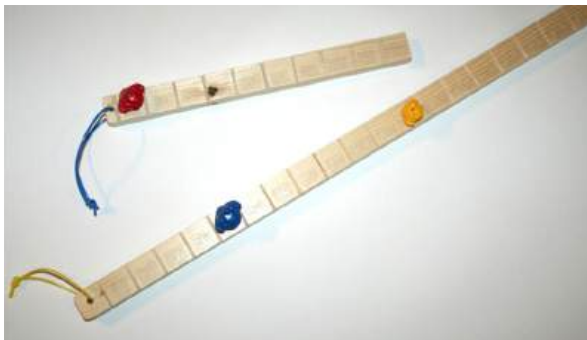

A number board with braille numbers. Throw the tactile dice and move the frog along the board by the number of spaces shown.

### 2.4.9

#### Braille clock

Useful for: **Blind, Low vision, Sighted**

You can make a braille clock out of card. Use a paper fastener to attach the hands to the clock face. Write the numbers in both normal text and braille so both sighted and blind students can use the clock.

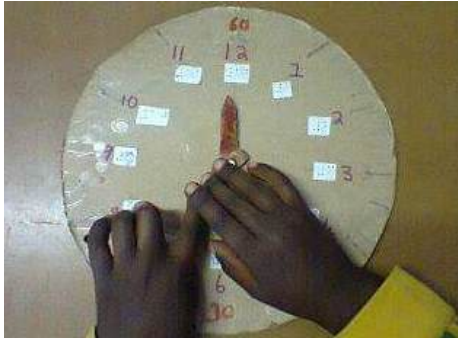

Tactile clock.

**2.4.10**

**Fraction tools**

**Useful for: Blind, Low vision, Sighted**

You can make (or buy) various tools to teach fractions. These include strips made from wood or cardboard, circles and pie slices, wooden blocks, and Lego. You can use materials with differently textured surfaces (corrugated card, sandpaper...) to make it easier to feel the various items. Add Velcro hooks on the back to keep them in place on a fuzzy work surface.

You can get the students to fold and then cut pieces of paper into fractions of the whole.

**More information**

Willings, C. Teaching students with visual impairments: Numbers & counting adaptations.

<https://www.teachingvisuallyimpaired.com/numbers--counting.html>



Fraction bars made from cardboard.

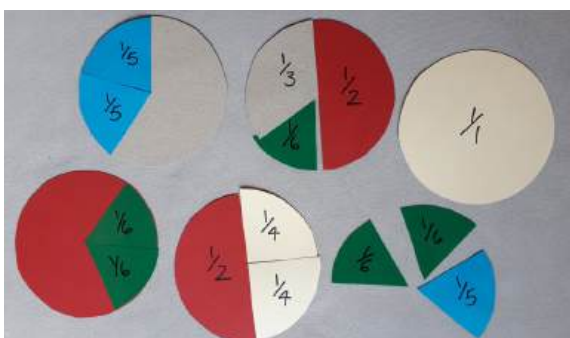

Fraction pies made from card. Better to make them from cardboard so they are easier to hold and feel. You can add stickers with braille to each pie slice to show the fractions.

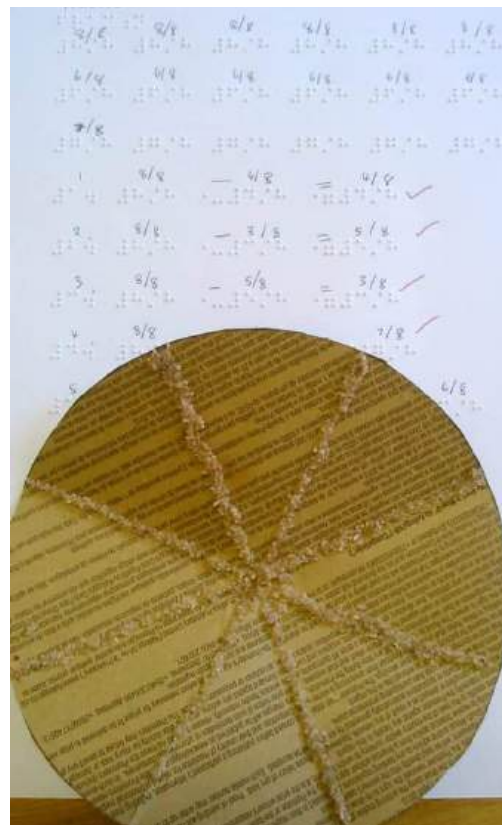

Tactile circle made from sand glued to paper, with exercise in braille.

## 2.5

**Mental arithmetic**

Useful for: Blind, Low vision, Sighted

Students who are blind or visually impaired often rely on their memory and on mental calculations more than sighted students do. Here are some tricks to make mental arithmetic easier.

## 2.5.1

**Adding using the “friends of 10”**

“Friends of 10” are pairs of numbers that together add up to 10:

$1 \leftrightarrow 9$     $2 \leftrightarrow 8$     $3 \leftrightarrow 7$     $4 \leftrightarrow 6$     $5 \leftrightarrow 5$

**Example:  $54 + 77 = ?$** 

Step 1: Find the nearest “friend of 10” for  $4 + 7$ : (this is  $3 + 7$ )

Step 2: Find the difference ( $4 - 3 = 1$ )

Step 3: Subtract the difference (1):  $54 - 1 = 53$

Step 4: Add together  $53 + 77 = 130$

Step 5: Add the difference back on:  $130 + 1 = 131$

**Answer:**  $54 + 77 = 131$

## 2.5.2

**Subtracting by rounding up**

To subtract two numbers, round the first number up to make the sum easier, subtract the numbers, then take away the extra you added on.

**Example:  $123 - 84 = ?$** 

Step 1: Round up 123 to 124 (extra = 1)

Step 2: Subtract 84 from 124:  $124 - 84 = 40$

Step 3: Take off the extra 1:  $40 - 1 = 39$

**Answer:**  $123 - 84 = 39$

## 2.5.3

**Rounding up to the nearest 10**

To add two numbers, round both of them up to the nearest 10 (remember how much you have added on), add the rounded numbers, then subtract the extra you added on.

**Example:  $54 + 77 = ?$** 

Step 1: Round up 54 to 60 (extra = 6)

Step 2: Round up 77 to 80 (extra = 3)

Step 3: Add the extras:  $6 + 3 = 9$

Step 4: Add the rounded numbers:  $60 + 80 = 140$

Step 5: Subtract the extras from this total:  $140 - 9 = 131$

**Answer:**  $54 + 77 = 131$

The same approach works with subtraction.

**Example:  $123 - 84 = ?$**

Step 1: Round up 123 to 130 (extra = 7)

Step 2: Round up 84 to 90 (extra = 6)

Step 3: Subtract the extras:  $7 - 6 = 1$

Step 4: Subtract the rounded numbers:  $130 - 90 = 40$

Step 5: Subtract the extras from this total:  $40 - 1 = 39$

**Answer:**  $123 - 84 = 39$

The same approach works with multiplication.

**Example:  $99 \times 80 = ?$**

Step 1: Round up 99 to 100 (extra = 1)

Step 2: Multiply the rounded numbers:  $100 \times 80 = 8000$

Step 3: Multiply the extra by the second number:  $1 \times 80 = 80$

Step 4: Subtract the answers:  $8000 - 80 = 7920$

**Answer:**  $99 \times 80 = 7920$

#### 2.5.4

##### Subtracting from 1000

To subtract a 3-digit number from 1000, subtract every number except the last from 9, and subtract the last number from 10.

**Example:  $1000 - 576 = ?$**

Step 1: Subtract 5 from 9 = 4

Step 2: Subtract 7 from 9 = 2

Step 3: Subtract 6 from 10 = 4

**Answer:**  $1000 - 576 = 424$

#### 2.5.5

##### Breaking sums down

To add two multiple-digit numbers, you can break the task down and work from left to right (rather than from right to left, as one would on paper).

**Example:  $34 + 17 = ?$**

Step 1: Add the tens column:  $30 + 10 = 40$

Step 2: Add the units column:  $4 + 7 = 11$

Step 3: Add the two answers:  $40 + 11 = 51$

**Answer:**  $34 + 17 = 51$

The same approach works with subtraction.

**Example:  $45 - 17 = ?$**

Step 1: Subtract the tens column:  $40 - 10 = 30$

Step 2: Subtract the units column:  $5 - 7 = -2$

Step 3: Add the two answers:  $30 + -2 = 28$

**Answer:**  $45 - 17 = 28$

The same approach works with multiplication.

**Example:  $25 \times 7 = ?$**

Step 1: Multiply the tens column:  $20 \times 7 = 140$

Step 2: Multiply the units column:  $5 \times 7 = 35$

Step 3: Add the two answers:  $140 + 35 = 175$

**Answer:**  $25 \times 7 = 175$

The same approach works with division.

**Example:  $234 \div 3 = ?$**

Step 1: Find a number close to 234 that is divisible by 3. Start with 210.

Step 2: Divide this number by 3:  $210 \div 3 = 70$

Step 3: Subtract 210 from 234:  $234 - 210 = 24$

Step 4: Divide 24 by 3:  $24 \div 3 = 8$

Step 5: Add the two division answers:  $70 + 8 = 78$

**Answer:**  $234 \div 3 = 78$

### 2.5.6

#### Multiplying by 5

To multiply an even number by 5, halve the number and add a zero.

**Example:  $5 \times 14 = ?$**

Step 1: Halve the number you multiply by 5. In this case:  $14 \div 2 = 7$

Step 2: Add a zero to the result:  $5 \times 4 = 70$

**Answer:**  $5 \times 14 = 70$

### 2.5.7

#### Dividing by 5

To divide a number by 5, double it and take off a zero.

**Example:  $65 \div 5 = ?$**

Step 1: Double the number:  $65 \times 2 = 130$

Step 2: Take off a zero (divide by 10):  $130 \div 10 = 13$

**Answer:**  $65 \div 5 = 13$

**2.5.8****Multiplying by 4 or 8**

To multiply a number by 4, double it twice. To multiply it by 8, double it again.

**Example:  $34 \times 4 = ?$  and  $34 \times 8 = ?$**

Step 1:  $34 \times 2 = 68$ .

Step 2:  $68 \times 2 = 136$ . Therefore  $34 \times 4 = 136$

Step 3:  $136 \times 2 = 272$ . Therefore  $34 \times 8 = 272$

**Answers:**  $34 \times 4 = 136$

$34 \times 8 = 272$

**2.5.9****Dividing by 4 or 8**

To divide a number by 4, halve it, then halve it again. To divide by 8, halve it one more time.

**Example:  $656 / 4 = ?$  and  $656 / 8 = ?$**

Step 1: Halve the number:  $656 / 2 = 328$

Step 2: Halve it again:  $328 / 2 = 164$ . Therefore  $656 / 4 = 164$

Step 3: Halve it again:  $164 / 2 = 82$ . Therefore  $656 / 8 = 82$

**Answers:**  $656 / 4 = 164$

$656 / 8 = 82$

**2.5.10****Multiplying by 11**

To multiply a two-digit number by 11, add the two digits together and put this sum between the original two digits.

**Example:  $14 \times 11 = ?$**

Step 1:  $1 + 4 = 5$

Step 2: Put the 5 between the 1 and the 4: 154

**Answer:**  $14 \times 11 = 154$

If the sum of the two digits is greater than 9, carry the 1 over to the tens digit.

**Example:  $39 \times 11 = ?$**

Step 1:  $3 + 9 = 12$

Step 2: Put the 2 from the 12 between the 3 and the 9, and add the 1 from the 12 to the 3 to make 4: 429

**Answer:**  $39 \times 11 = 429$

## 2.5.11

**Is a number divisible by...?**

Here are quick ways to determine if a number is divisible by 2, 3, 4, 5, 6, 8, 9 and 10.

The number is divisible by...

**2:** If the number ends in an even number: 0, 2, 4, 6 or 8.

**Example: Is 1348 divisible by 2?**

1348 ends in an 8, which is an even number

**Answer:** 1348 is divisible by 2

**3:** Add up the individual digits and check whether the sum can be divided by 3.

**Example: Is 114 divisible by 3?**

$1 + 1 + 4 = 6$  (and 6 is divisible by 3)

**Answer:** 114 is divisible by 3

For larger numbers, in a second step you can add the digits of the sum to see if the result is divisible by 3.

**Example: Is 1569 divisible by 3?**

$1 + 5 + 6 + 9 = 21$

$2 + 1 = 3$  (and 3 is divisible by 3)

**Answer:** 1569 is divisible by 3

**4:** If the number ends in 00 or in a two-digit number divisible by 4.

**Example: Is 126356 is divisible by 4?**

The last two digits are 56, which is divisible by 4

**Answer:** 126356 is divisible by 4

**5:** If the number ends in 0 or 5.

**Example: Is 125 is divisible by 5?**

125 ends in a 5

**Answer:** 125 is divisible by 5

**6:** If it is an even number and if the sum of the digits is divisible by 3.

**Example: Is 3456 divisible by 6?**

3456 is an even number, so is divisible by 2

$3 + 4 + 5 + 6 = 18$ , which is divisible by 3

A number that is divisible by 2 and by 3 is also divisible by 6

**Answer:** 3456 is divisible by 6



**8:** If the number ends in 000 or if its last three digits are divisible by 8.

**Example: Is 3456 is divisible by 8?**

The last three digits are 456, which is divisible by 8

To check this, halve 456 three times:  $456 \blacktriangleright 228 \blacktriangleright 114$ . Because 114 is a whole number, 456 is divisible by 8

**Answer:** 3456 is divisible by 8

**9:** if the sum of the digits is divisible by 9.

**Example: Is 117 divisible by 9?**

$1 + 1 + 7 = 9$  (which is divisible by 9)

**Answer:** 117 is divisible by 9

For larger numbers, in a second step you can add the digits of the sum to see if the result is divisible by 9.

**Example: Is 45684 is divisible by 9?**

$4 + 5 + 6 + 8 + 4 = 27$

$2 + 7 = 9$

**Answer:** 45684 is divisible by 9

**10:** If the number ends in 0.

**Example: Is 130 is divisible by 10?**

130 ends in a 0

**Answer:** 130 is divisible by 10

## 2.5.12

### Making a guesstimate

Encourage students to make a guesstimate first before working on the details.

**Example:  $123 \times 45 = ?$**

Step 1: 123 is a little more than 120, and 45 is somewhat less than 50

Step 2:  $120 \times 50 = 6000$

**Answer:** The answer must be a little less than 6000

(The correct answer is  $123 \times 45 = 5535$ )

### More information

Best, J. 2020. 6 mental math strategies: Tips and tricks for students. 3P Learning.

<https://www.3plearning.com/blog/mental-math-strategies/>

The Organic Chemistry Tutor. 2017. Mental math tricks - addition, subtraction, multiplication & division!

<https://www.youtube.com/watch?v=nTn9gVqRfKY>

van Leendert, A. 2023. Worksheets Euromath. Trucs en tips voor hoofdrekenen. (Tricks and tips for mental arithmetic).

<https://www.eduvip.nl/cms/files/13-Trucs-en-tips-voor-hoofdrekenen.docx> (in Dutch)

## 2.6 Drawings and graphs

You can make tactile drawings (drawings that can be felt with the fingertips) for blind students in many different ways. Each technique has its advantages and disadvantages. Choose the most appropriate method depending on the materials and equipment you have available and the purpose of the drawing. We list the materials that are useful in most situations first, followed by those that are very specific. **Part 3: Drawing** gives suggestions on how to use tactile drawings in teaching.

Blind students can use most of the techniques in this section to produce their own drawings. This will require some practice, but do not hesitate to challenge your blind or visually impaired students to start drawing. It will improve their skills and their understanding of mathematical concepts.

### 2.6.1

#### Guidelines for tactile and large-print drawings and graphs

Useful for: Blind, Low vision

##### Keep it simple

Tactile or large print drawings can be extremely helpful in understanding the topic, but if they contain too much information, they might be hard (or impossible) to understand.

When making a drawing for a blind or visually impaired student, make the image as lean as possible.

Leave out everything that can be left out. Ask yourself the following questions:

- Does the student need a **grid**? They only need a grid if they have to read values from the axes. Simplify the grid as far as possible, and consider leaving it out completely. In drawings, simplify as far as possible. Omit shading or hatching.
- Does the student need the **axes**? If the goal of an image is to get familiar with the shape of a function, you could even leave the axes out.
- How to distinguish between the **axes**, **gridlines** and **function curve**? For example, you could use dashed lines for the axes, dotted lines for the gridlines, and an unbroken line for the function curve. You could extend the axes a little further so they are easy to find.
- Gridlines should be at least 1.5 cm apart. If they are closer together, it will be hard for a student to determine the position of a pin used to mark a position on the graph. For braille users, you can use two different textures for the heavy and light lines.
- Do not put more than 2 curves in the same graph.

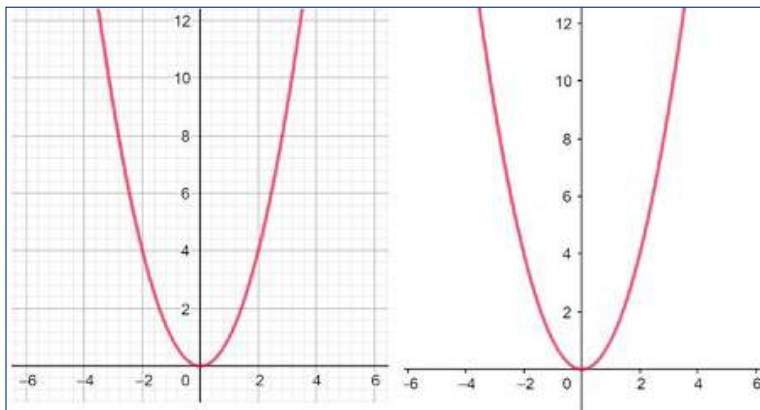

Removing the background grid makes a graph easier for low-vision students to use. For blind students, a braille version (also without the grid) is needed.



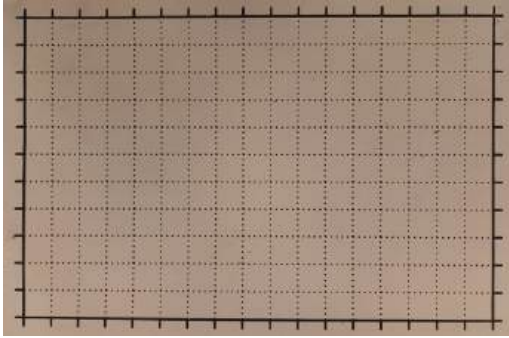

A simple coordinate system for beginners with one quadrant and tick marks along all the edges to make counting easier.

## 2.6.2 Techniques

### Folding and cutting card

#### Useful for: Blind, Low Vision, Sighted

You can make geometric shapes such as squares, triangles and circles out of card or cardboard. You can get the student to fold them to find the centre, and fold and cut them into equal parts to make fractions. Card can also be used for measuring lengths, matching shapes, calculating areas and perimeters, making nets, etc.

### Tactile graph paper

You can make reusable coordinate sheets using many different methods:

- **Homemade:** drawing foil, plastic file pockets, relief paint, braille dot patterns, swell paper. See below in this section for details.
- **Commercial:** geoboard (see below), cube frame (see **Cube frame or cubarithm**) and Taylor frame (see **Taylor frame**).

The commercial options limit you to fixed positions. The homemade coordinate systems allow you to place the pins in between the gridlines. They can be used for a wider range of graphs, so are preferable for higher levels of maths.

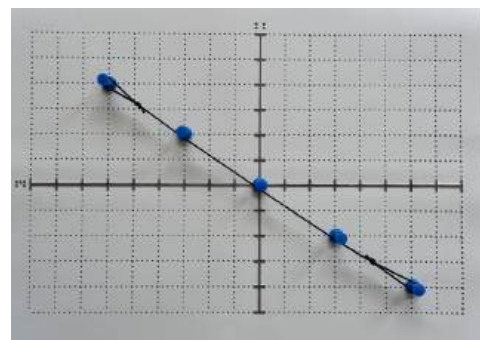
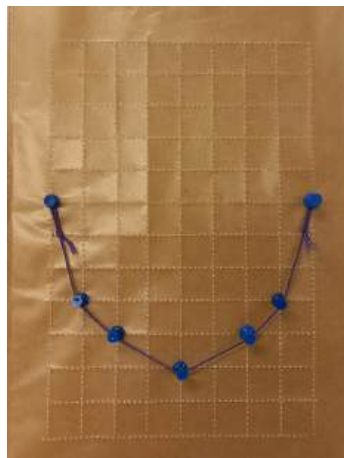
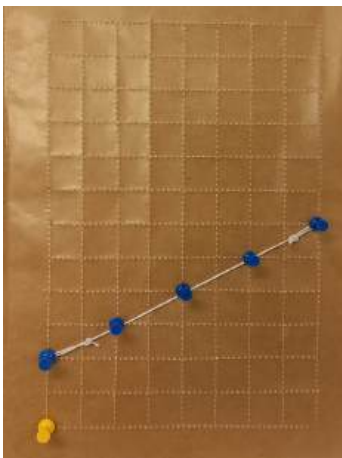

Examples of reusable coordinate systems using pushpins on a pinboard base.

You can make bar chart on a reusable coordinate grid. Sighted students will colour the bars on paper, while blind students can fill up the bars of the coordinate grid with pushpins.

**Drawing foil**

**Useful for: Blind**

Drawing foil is also called embossing film or German film. It is a plastic sheet that pops up where a pen or pencil runs over it. Put a rubber mat underneath it and draw using a regular pen or pencil. A blind student can easily use drawing foil to write by themselves, since they can feel while they are drawing. Drawing foil is good for drawing maps.

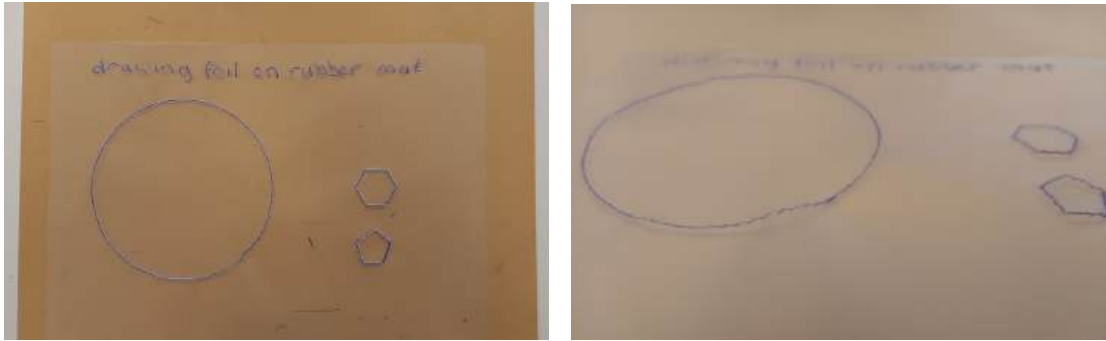

Drawing foil.



Several types of rubber mats that are used with drawing foil.

**Sources of drawing foil**

RNIB. <https://shop.rnib.org.uk/embossing-film?LC22>

Brailletec. <https://en.brailletec.de/our-products/consumables/>

**Plastic file pocket + tracing wheel**

**Useful for: Blind, Low vision**

A plastic file pocket is also known as a "sheet protector", "transparent document folder" or "punched pocket". It is used to protect documents and keep them together in a file folder. You can make tactile drawings on the plastic, then put the drawing inside the file pocket so students with low vision can both feel and see the drawing, and so teachers and classmates know what the drawing is.

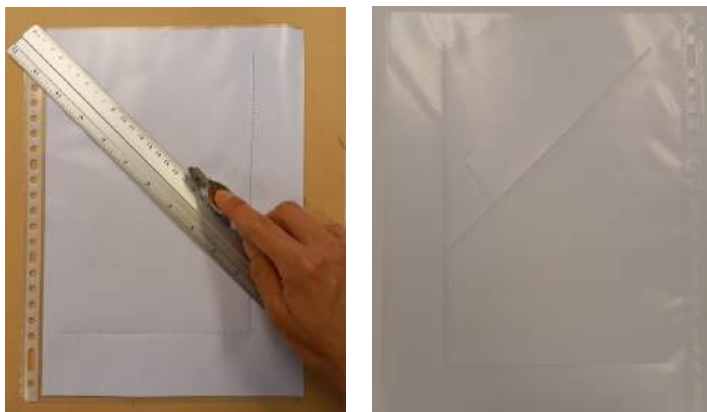

Tactile graphs using plastic file pockets.

After making your drawing, you have to turn the plastic over to read it. That means you must make your drawings **mirrored**.

You can use a ballpoint pen to make drawings on the plastic. Put the plastic on a rubber mat or a piece of card before making the drawing. You have to press quite heavily to make an indentation on the bottom of the plastic.

A better option is to use a **tracing wheel** or spur wheel (a metal wheel with sharp points, obtainable from a dressmaker or tailor) to perforate the plastic. The points on the wheel perforate the plastic, making bumps on the underside.



A tracing wheel or spur wheel.

1. Make a drawing (such as a graph) on a piece of A4 paper. Use heavy ink so you can see the drawing through the reverse side of the paper. Write the text (such as the labels for axes) on the reverse side.
2. Put the paper reverse side up on a rubber mat. Fix a file pocket on top of it with masking tape so it does not move around.
3. Use the tracing wheel to trace the drawing. Press firmly enough so the wheel makes bumps through both layers of plastic.
4. Add braille text using a slate and stylus.
5. Add notes on the paper drawing for the teacher or sighted peers, and put it in the file pocket.



Projection of a cylinder made with a tracing wheel.

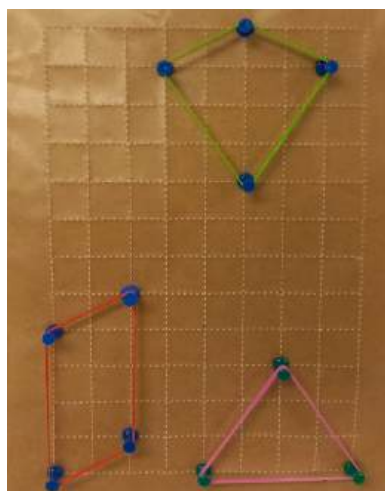

A reusable coordinate grid made with a tracing wheel, with pins and rubber bands to form shapes.

### Velcro & wool

#### Useful for: Blind, Low vision, Sighted

You can use yarn, wool or cord to create tactile lines on a surface of Velcro hooks. The fabric sticks to the Velcro and can be felt by blind and visually impaired students. A big advantage over most alternatives is that the student can adjust the lines and change the drawing.

The Lensen drawing kit and Rainbow cord (see below) are both commercially available. You can also make your own drawing kit using Velcro, wool and (optionally) a pen.

**Lensen drawing kit.** The Lensen drawing kit contains a Velcro drawing sheet and yarn (wool). The kit contains a “pen” with a spool for the wool. At the tip of the pen is a cutter to cut the wool.



Lensen drawing kit.

**Rainbow Cord.** Rainbow Cord comes with a Velcro drawing sheet and a set of cords. The cords come in two lengths and can be reused. The Rainbow Cords have fixed lengths, while the “woolpen” in the Lensen kit has a cutter to adjust the wool length as required.



Rainbow Cord.

### More information

Rainbow Cord. <https://www.melissaanddoug.com/products/rainbow-cord-picture-pattern-maker>

Lensen website: [klongdinsor.com/lensen-drawing-kit](http://klongdinsor.com/lensen-drawing-kit)

Lensen Drawing Kit. [youtube.com/watch?v=JZsGS8eijXY](https://www.youtube.com/watch?v=JZsGS8eijXY)

### Relief paint or glue

**Useful for:** Blind, Low vision, Sighted

Relief paint is more accurate, easier to work with and dries faster than glue, but with some practice simple glue gives useful results too.

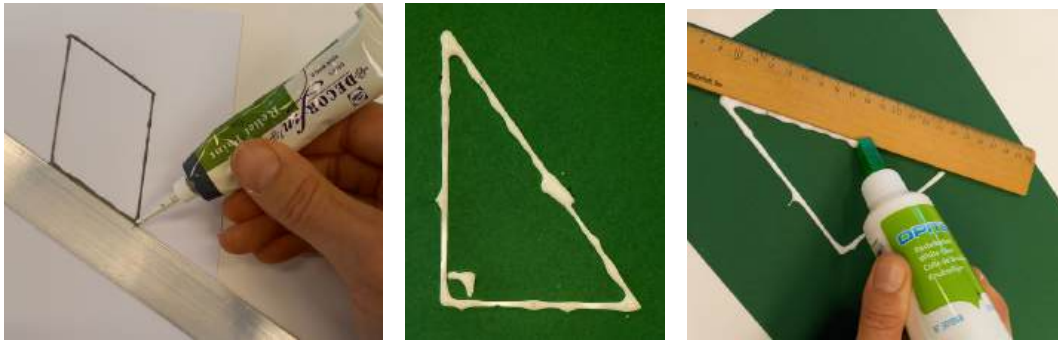

Using relief paint or glue for drawing.

### Cardboard or hobby foam

**Useful for:** Blind, Low vision, Sighted

Cardboard or hobby foam can be made to illustrate mathematical concepts. On the left is a picture that illustrates how the areas of a parallelogram, a rectangle, and the two triangles relate. On the right, the three triangles illustrate the concept of magnification factor.

You can stick a strip with Velcro hooks on the back of the shapes so they stick on a fuzzy surface such as Velcro loops or a towel.

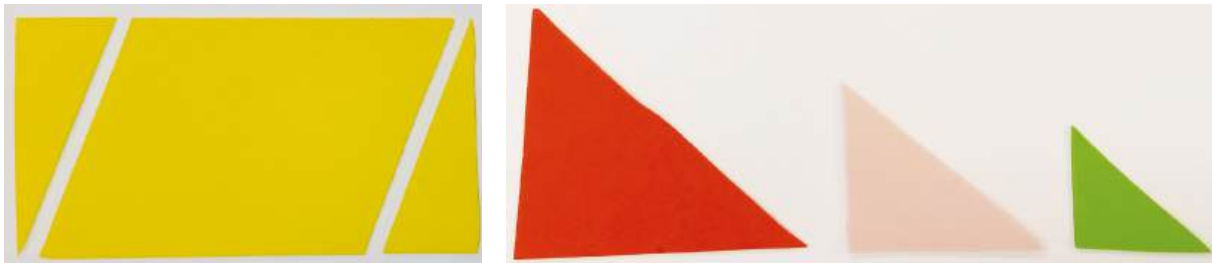

Shapes made from card or hobby foam.

### Metal wires or wax sticks

**Useful for:** Blind, Low vision, Sighted

Any material that is bendable can be used to form geometric shapes (triangles, rectangles, etc) or graph shapes (as in the pictures below).

Wax sticks adhere to a flat surface, so are easy to observe by touch. They stick better to plastic and metal surface than to paper or wood. The brand used in the pictures is Wikki Stix. Wax sticks can also be made from string and a mix of melted beeswax and mineral oil.

Metal wires keep their shape better than wax sticks. The student can hold them in their hands.



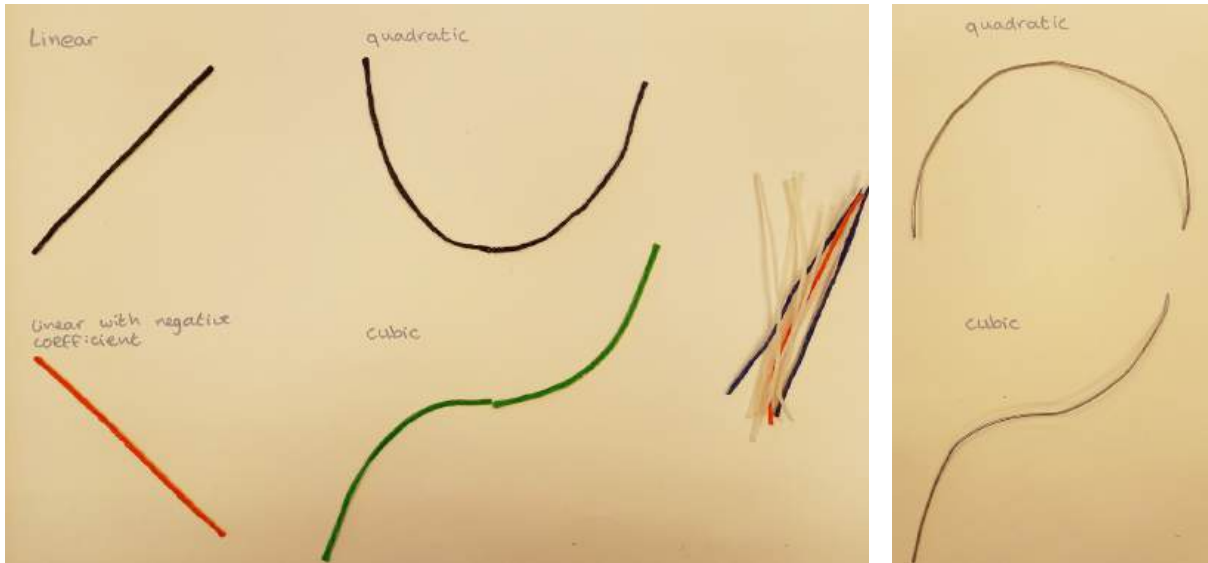

Graph curves made using wax sticks (left) and metal wire (right).

### Geoboard with protruding pins

**Useful for: Blind, Low vision, Sighted**

A geoboard, nailboard or pegboard is a board with a regular pattern of pins or holes. They are commercially available in various sizes and colours. A 10 by 10 grid is a good start. Geoboards may have square, triangular or circular patterns of pins.

You can make your own geoboard from a piece of wood and nails. Make sure the nails are at least 1.5 cm apart.

For students with low vision, wood or opaque plastic works better than transparent plastic. An advantage of a homemade geoboard is that the contrast between the wood and nails is good. On a plastic board, it helps to colour the pins with a marker in a contrasting colour.

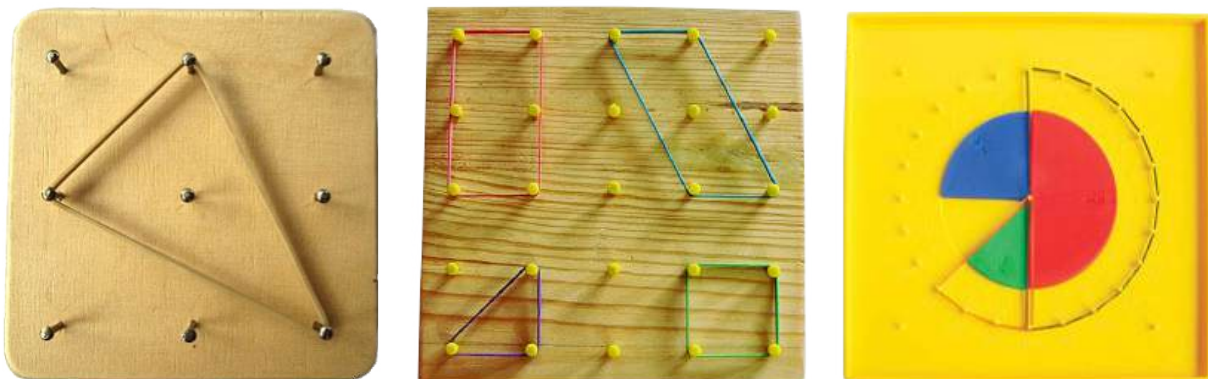

Geoboards with rubber bands to depict geometric shapes, nets and graphs.

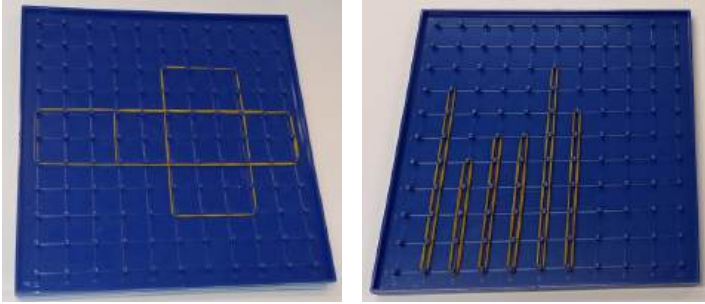

Geoboards with rubber bands to depict geometric shapes, nets and graphs.

**Geoboard with holes and separate pins**

**Useful for: Blind, Low vision, Sighted**

Geoboards with holes and separate pins or pegs have a better tactile experience for students, especially if the pins have a rounded shape. You can buy the boards and suitable pins from a hardware store. You can also make your own from a piece of wood or hardboard and a drill. For pins, you can use nails, screws or sticks. Make sure the pins have smooth or rounded tops.

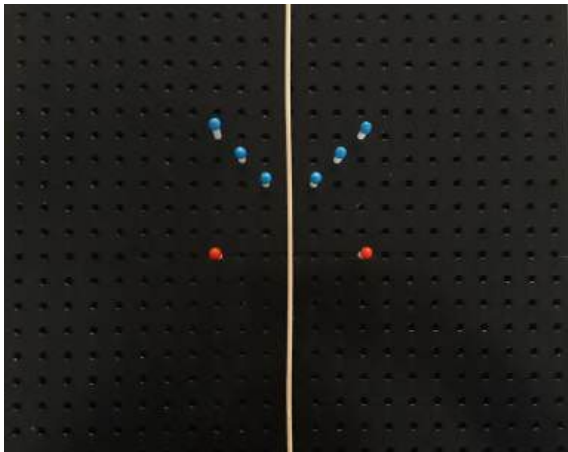

A wooden rod represents a mirror. The pins on the left and right depict an image and its reflection.

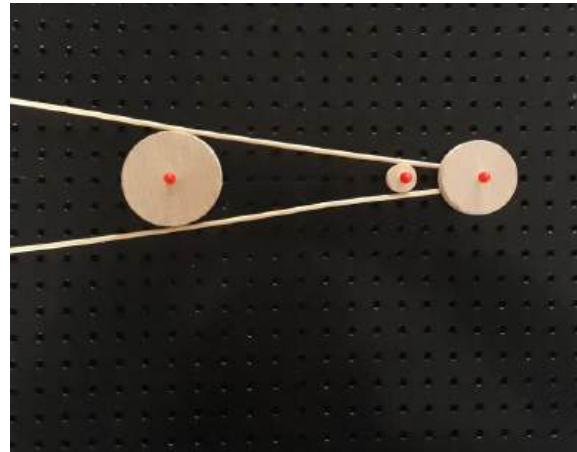

A solar eclipse. Three wheels represent the sun, moon and earth. The rods represent the rays of light from the sun and show that the solar eclipse can be observed from only part of the earth.

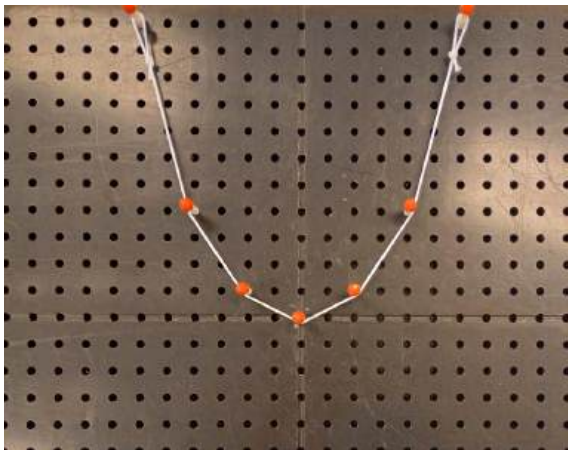

A parabola made using pins and cord.

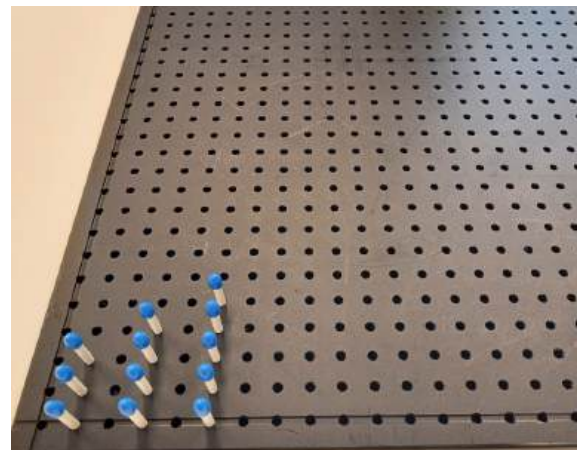

A bar chart made with pins.



Using a braille slate as a geoboard.

You can also use an A4 braille slate as a geoboard. Stretch rubber bands across it to make quadrants, and use plasticine, UHU Tack (a sticky putty) or Play-Doh (children's modelling clay) to mark points on the grid.

### Swell paper

#### Useful for: Blind

Swell paper is heat-sensitive paper that is used to produce tactile drawings. You can draw on the paper with a black marker, or use a photocopier or printer to produce the drawing. You then pass the swell paper through a swelling machine that heats it and makes the areas with black ink swell.

See [youtube.com/watch?v=QXsByoZaEwc](https://www.youtube.com/watch?v=QXsByoZaEwc) for a demonstration.

You can use a computer to add braille to drawings. When printed on swell paper and heated, the braille text becomes tactile.

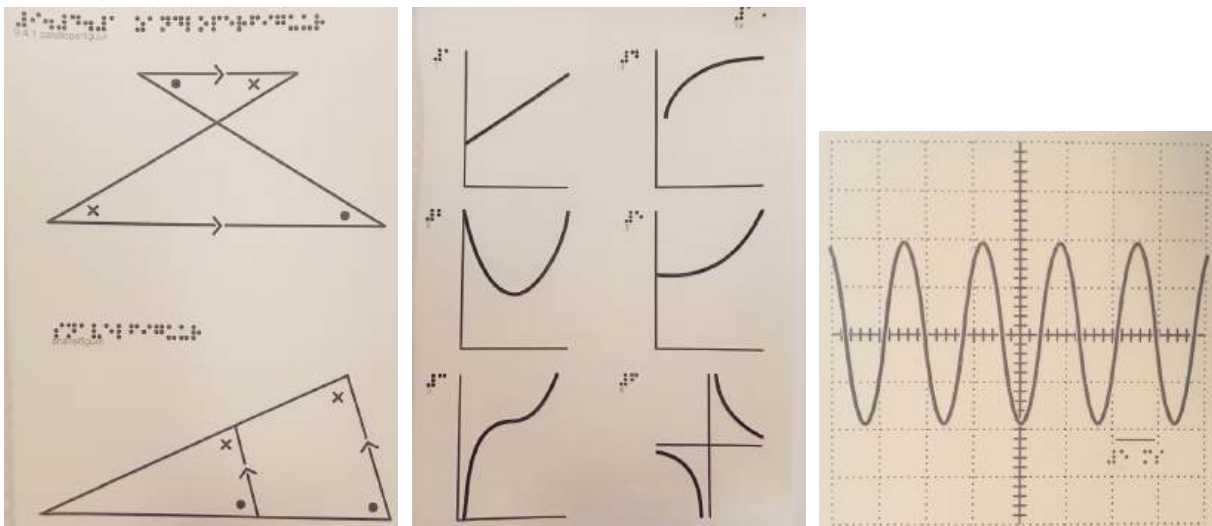

Diagrams made on swell paper.

Dedicated swelling machines are expensive: in 2021, one cost about €1300 / \$1400. It is possible to hold the swell paper close to a heat lamp, but this can produce uneven results and requires care as the paper may char or catch fire.



The swelling machine heats the paper and causes the inked areas to swell.

### More information

American Thermoform Corp. [Swell form tactile graphics. https://www.youtube.com/watch?v=QXsByoZaEwc](https://www.youtube.com/watch?v=QXsByoZaEwc)

### Meccano

**Useful for: Blind, Low vision, Sighted**

These construction toys are very suitable for making triangles, parallelograms, polygons, etc. You can also use them as drawing guides, for example to draw parallel lines.



Meccano can be used to make shapes.

### Whiteboard with magnetic accessories

**Useful for: Blind, Low vision, Sighted**

You can use a whiteboard or a metal sheet together with magnetic accessories. You can get magnetic accessories from office-supply stores or specialist stores for teaching. Rather than standing at a whiteboard, a blind or visually impaired student can have a small metal sheet on their desk.

Magnetic sheets or films come in various colours and sizes. You can cut them with scissors to make shapes. Magnetic cord is useful for making curves on graphs. Magnetic squares and tape can be used to make bar charts. All these items can be reused.

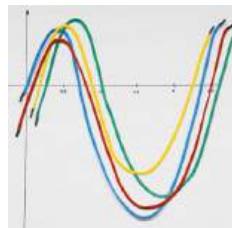

Magnetic sheets, cord, squares and tape.

**More information** <https://www.timetex.com/en-de/search?sSearch=magnet>

**Cube frame**

**Useful for: Blind**

A cube frame is a workboard with a grid of square cells. You can put special plastic cubes into the cells to denote numbers, equations, axes and points. See **Cube frame or cubarithm** for details.

**Taylor frame**

**Useful for: Blind**

A Taylor frame is a geoboard with special pins that can be rotated to denote numbers. See **Taylor frame** for details.

**Lego**

**Useful for: Blind, Low vision, Sighted**

Lego (and similar interlocking blocks) have many uses, including to make 2D and 3D shapes and bar charts. Because the bricks are firmly attached to each other, the student can observe a structure by touch without dislodging them.

Lego blocks are a suitable way to train 3D concepts such as top view, front view and side view. See **Part 3: 3D geometry** for details.



A cube frame can be used to make shapes and graphs as well as for calculations



A Taylor frame can be used to create graphs: the type is used to mark the axes and points.

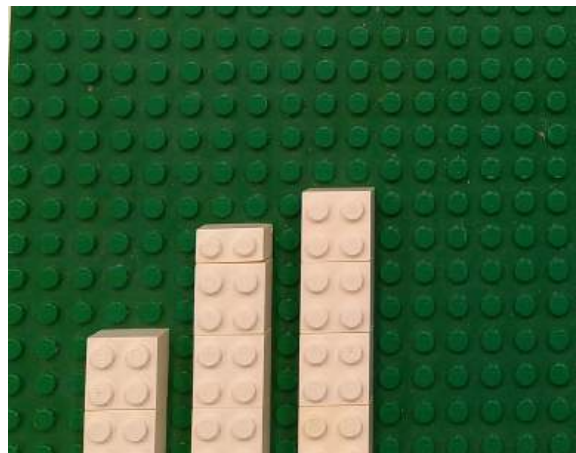

A bar chart made from Lego

### Cubes

**Useful for:** Blind, Low vision, Sighted

You can use small wooden cubes to make bar charts. To hold them in place in the columns, use wooden rods (or wire, cardboard or other material) fixed to the baseboard.

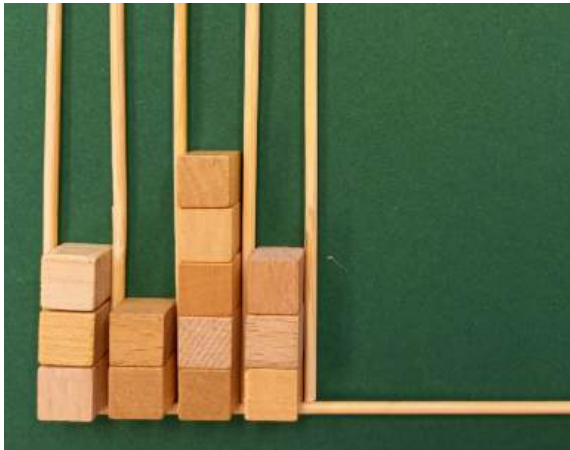

A bar chart made from wooden cubes and rods.

### 2.6.3

#### Braille

**Useful for:** Blind

**Part 2: Braille** describes braille and how to write it. This section offers some ideas on how to use it to make drawings and graphs.

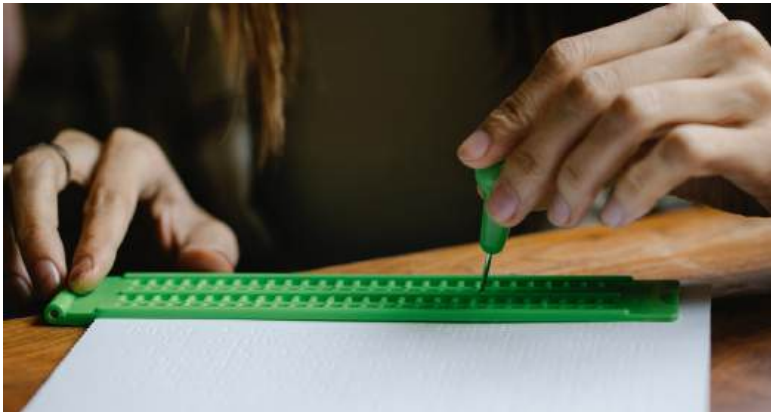

Using a slate and stylus to write braille.

#### Drawing with dots

A column of dots made up of the braille letter l  $\begin{smallmatrix} \bullet \\ \bullet \\ \bullet \end{smallmatrix}$  forms a vertical line or graph axis.

A horizontal row of dots of the braille hyphen  $\bullet\bullet$  forms a horizontal line or axis.

The junction of the vertical and horizontal lines, or the origin of a graph, is the braille letter v  $\begin{smallmatrix} \bullet \\ \bullet \\ \bullet \\ \bullet \end{smallmatrix}$ .

Other braille symbols can be used to form lines, tick marks on axes, curves, shapes and bars. You can add labels in braille just as you would in regular printed diagrams.

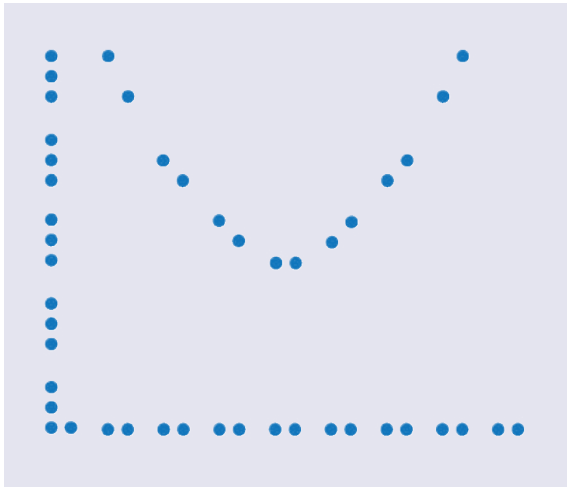

Braille dots used to draw a graph.

### Number line

You can combine patterns of braille dots with braille labels to make a number line. Students can use this to practise counting, arithmetic, etc. You can make several number lines for integers, fractions, negative numbers, etc. Make the number line on sturdy paper or plastic so it can be reused or displayed on the wall.

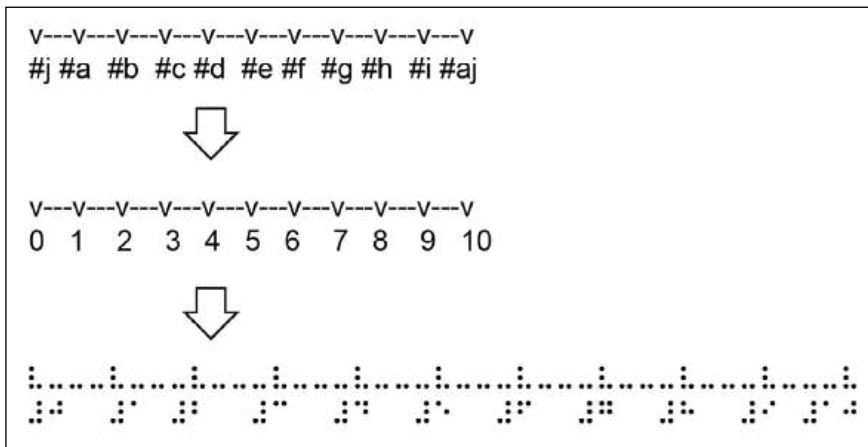

Number line in braille (bottom). Braille numbers are formed by the # character followed by a letter a-j. This is shown at the top.

In the middle is the braille interpretation. The line is made of hyphens and the ticks are formed by the letter v.

**Reusable coordinate system**

You can create reusable coordinate systems using braille. Once complete, attach the paper to a pinboard and plot the points with pushpins at the appropriate coordinates. Connect the points with rubber bands, as with the other coordinate systems described above.

Below are three options for coordinate systems using braille. See the appendices for ready-to-print files of these systems.

**Braille coordinate system with numbers (one quadrant).**

The tick marks on both axes are formed with the braille letter p  $\text{⠏}$ :

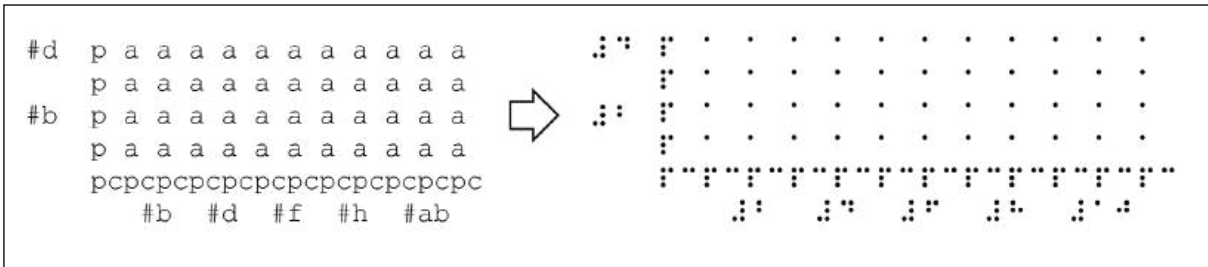

Reusable coordinate system with numbered axes, made with braille.  
The numbers are on the vertical and horizontal axes (#b = 2, #d = 4, etc.)

**Braille coordinate system without numbers (one quadrant).**

This coordinate system has no numbers on the axes.

The horizontal axis has alternating 2- and 3-dot tick marks (letters f  $\text{⠋}$  and p  $\text{⠏}$ ).

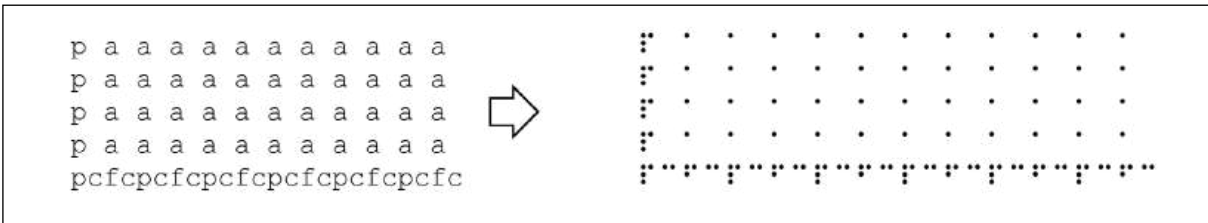

Reusable coordinate system without numbered axes, made with braille.

**Braille coordinate system with four quadrants.**

This coordinate system has no numbers on the axes.



Reusable coordinate system with four quadrants, made with braille.



**Bar charts**

The full braille cell of six dots  $\begin{smallmatrix} \bullet & \bullet \\ \bullet & \bullet \\ \bullet & \bullet \end{smallmatrix}$  can be used to form a bar chart or frequency table. To make the chart easier to read, transpose it (flip the axes so the bars are horizontal) and omit any unnecessary detail (such as grid lines and the axis labels).

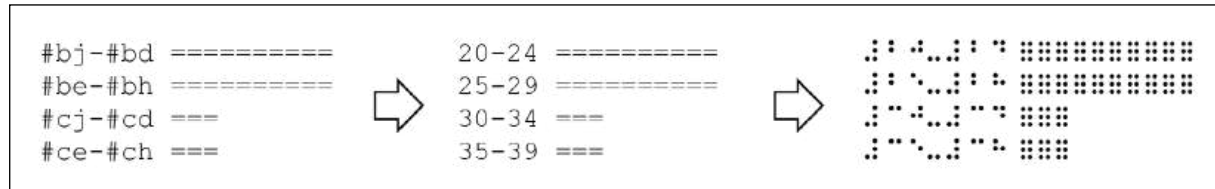
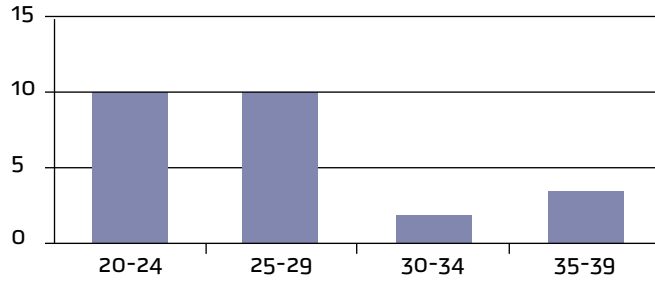

Original bar graph (above) and its equivalent in braille (below right).  
The braille encoding is on the far left; the braille meaning is in the centre.

## Appendices

### Braille coordinate systems

Useful for: Blind

Ready to emboss on swell paper.

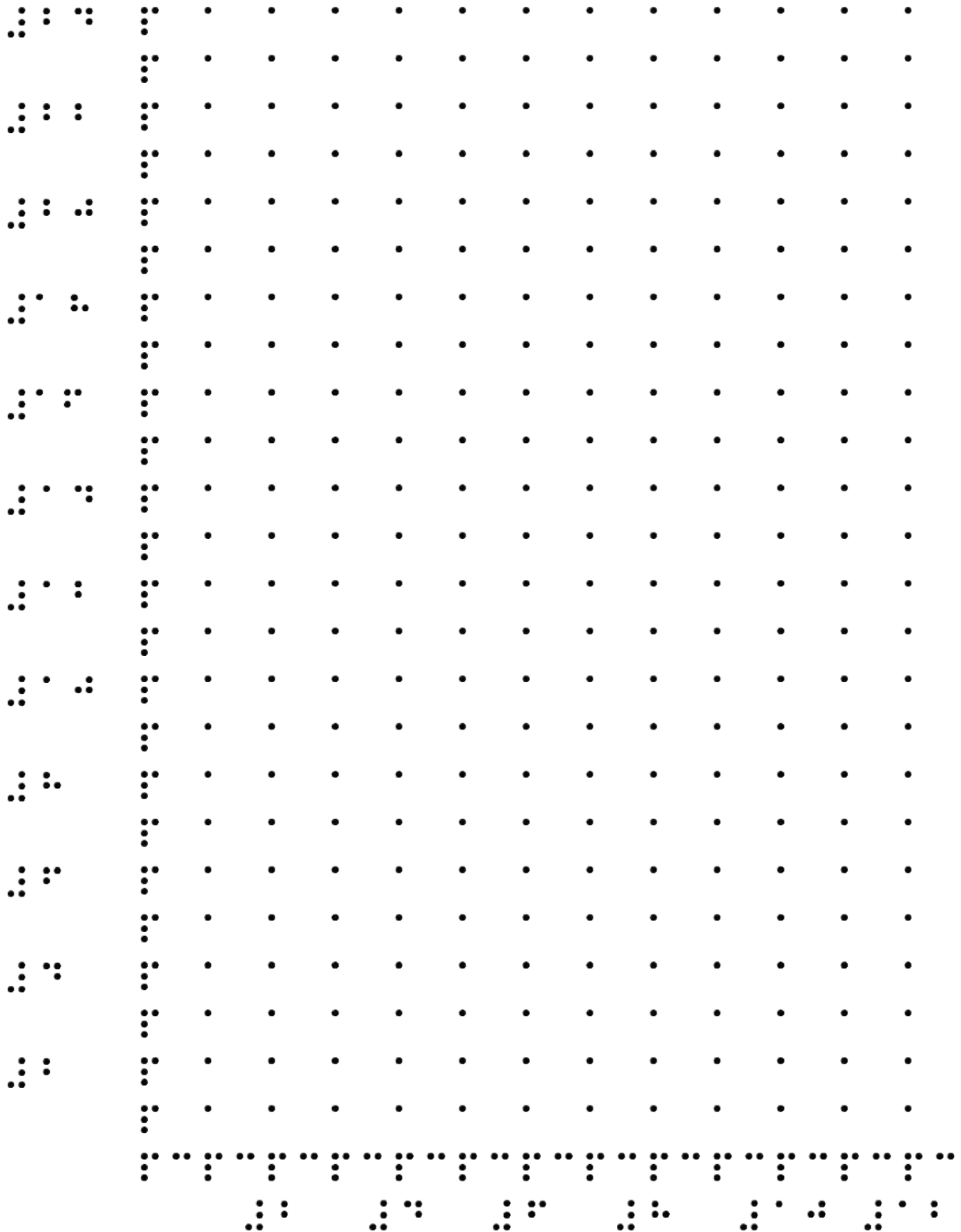

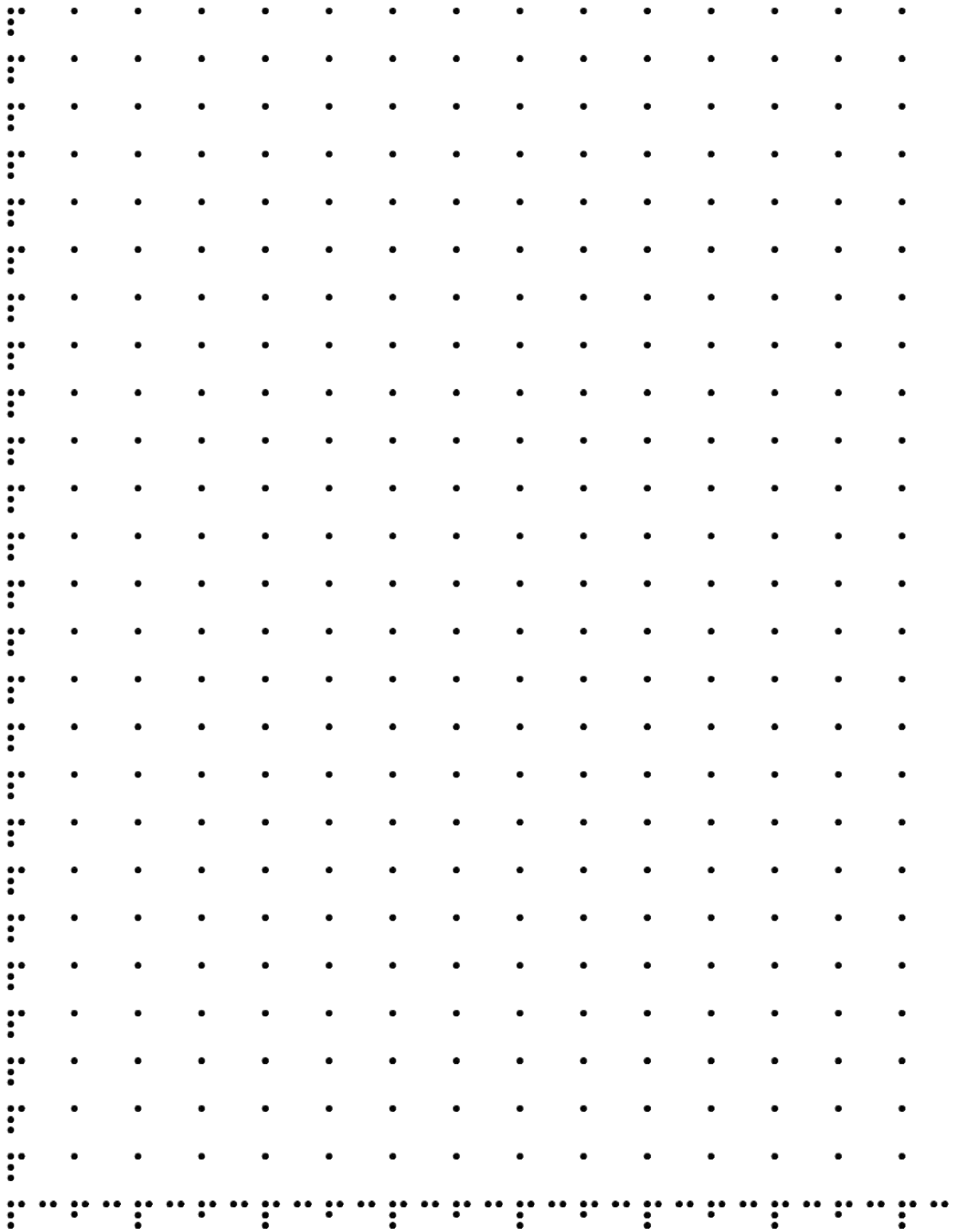

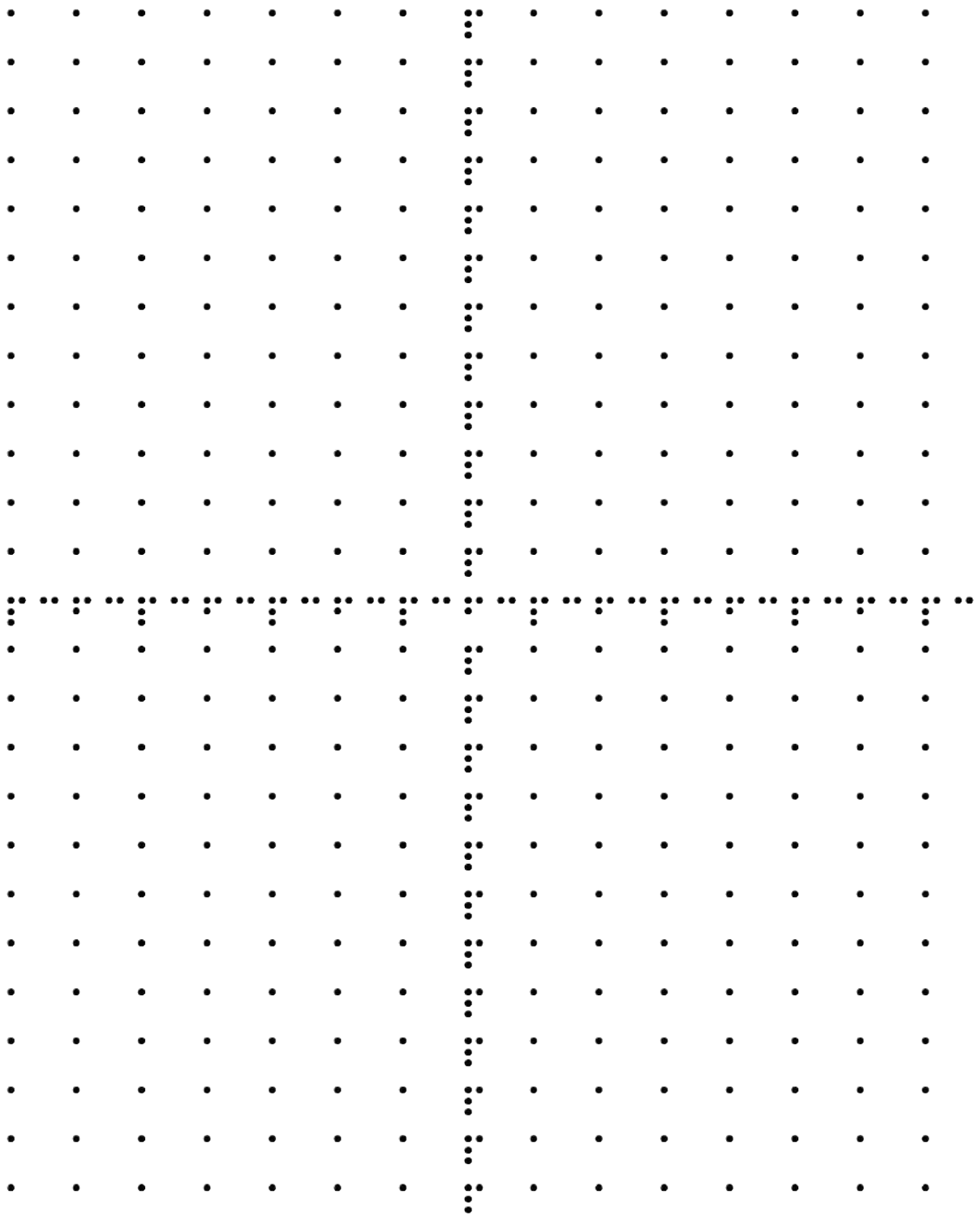

### 2.6.4

#### Types of drawings and graphs

##### Number line

You can make a number line using many of the methods listed in the section on **Counting and arithmetic tools** above.

You can make a number line that sighted, low-vision and blind students can all use. This has big, visible printed or handwritten numbers, coloured backgrounds (be consistent in the use of colours), braille labels, and "bumpons" (transparent stick-on bumps, used as doorstops in cupboards). The bumpons make it easy to count tactilely.

Instead of bumpons, you can make bumps with candle wax, relief paint or glue.



Homemade number lines with braille labels and bumpons (the circular transparent dots on top of the numbers).

See the section on **Braille** above for how to make a number line with braille.

##### Geometric shapes

You can make shapes with straight lines such as triangles and squares using many of the methods listed in the section on **Drawings and graphs**. See below for how to make circles.

##### Circles and pie charts

###### Useful for: Blind, Low vision, Sighted

The techniques that work best for circles are:

- Folding and cutting card
- Drawing foil
- Swell paper
- Metal wire (for the circle) and wax sticks (for the slices)
- Relief paint or glue
- Plastic file pocket.

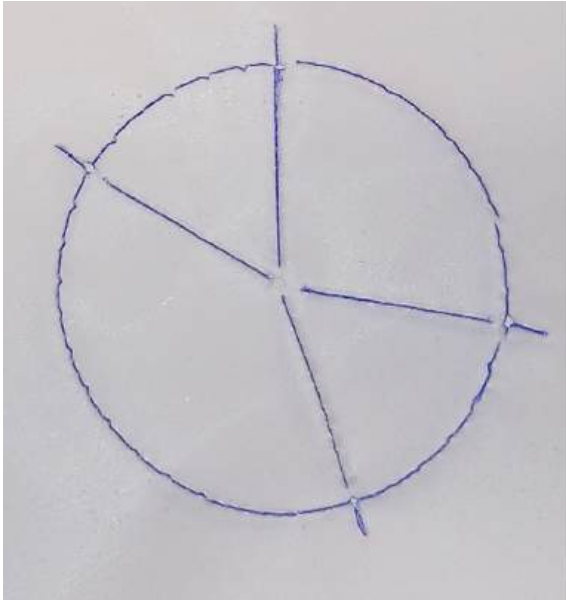

A tactile pie chart made by sewing thread through holes in a plastic sheet.

You can make a reusable pie chart:

- Use a plastic file pocket, relief paint or wire to draw the circle as the base.
- Mark the centre of the circle with a pushpin, relief paint, or adhesive putty.

Using this reusable pie chart base, you can draw sectors and move them around to create new pie charts. You can use these materials to make sectors:

- Wax sticks
- Sticks or small rods and adhesive putty
- Rubber bands and pushpins (in combination with a plastic file pocket on a pinboard)
- A ruler and a pen (on drawing foil)
- Pieces of card or foam.

With a reusable pie chart base, the student can easily make the pie chart sectors alone.

See **Part 3: Graphs** for a step-by-step approach on how to teach a blind student to draw a pie chart.

### Line graphs

You can make a line graphs using many of the methods listed in the **Measurement and drawing tools** section. Use a reusable coordinate system as a base. Use pushpins, pegs or mails to mark points. Stretch rubber bands or cord between them to form lines and curves. Alternatively, use waxed cord or wire for the curves.

### Bar charts

Most of the same methods can be used to make bar graphs. Use a reusable coordinate system as a base. Use rows (or columns) of pushpins to show the bars, or stretch a rubber band between two pins: one at the base of the bar and one at its top.

Lego, magnetic strips or cardboard can also be used to make bar charts.

See the section on **Braille** for how to make a bar chart with braille.

### More information

Allman, C. B. 2009. Making tests accessible for students with visual impairments: A guide for test publishers, test developers and state assessment personnel. Louisville, (K): American Printing House for the Blind. <https://sites.aph.org/wp-content/uploads/2017/09/Test-Access-Making-Tests-Accessible-2009.pdf>

APH Tactile graphic image library. Algebra. (Requires free registration; uses Nemeth notation) <https://imagelibrary.aph.org/portals/aphb/#category/83>

APH Tactile graphic image library. Geometry. (Requires free registration; uses Nemeth notation) <https://imagelibrary.aph.org/portals/aphb/#category/85>

Braille Authority of North America, 2010. Guidelines and standards for tactile graphics. <http://www.brailleauthority.org/tg/web-manual/index.html>

## 2.7 Measurement and drawing tools

### 2.7.1 Holding drawings in place: Baseboards

#### Useful for: Blind, Low vision

It is difficult for blind and visually impaired students to keep their work in place. If it moves, they may not realize this, so will produce disjointed drawings as a result.

#### Pinboard and pins

A pinboard is very useful to keep their work in the correct position. This can be combined with a reusable coordinate grid to construct graphs and pie charts.

The best material for a pinboard is softboard (also known as caneboard or canite). Corkboard is another option. Softboard is preferred because its surface is smoother than that of cork. That makes it easier to draw on because the pen runs smoothly across the surface.



Two types of pinboard. The surface should be reasonably smooth to make drawing easy.

A pinboard should be at least 1 cm thick so the pushpins will not scratch the desk surface beneath. A4 size is large enough for blind students. A student who works with enlarged pictures might prefer a pinboard up to A3 size, but this depends on the student's preference.

The student can use pins to hold the paper or reusable grid in place. They can also use pins to hold tools such as the ruler, compass, parallelogram or protractor in place, or shapes made from card or foam.

They can use the pinboard in combination with a rubber mat and drawing foil to make tactile drawings.

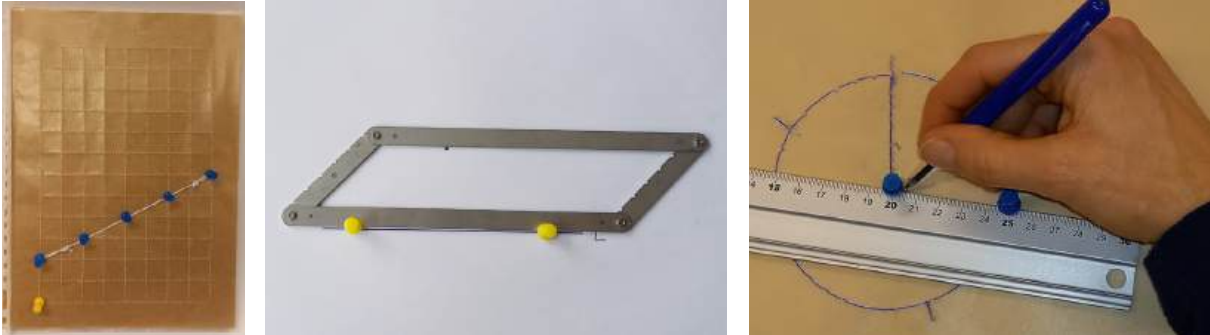

Using a pinboard as a base to make graphs, draw parallel lines, and draw a pie chart.

### Magnetic board

For some purposes a metal board makes a good base. The paper and base grid can be held in place with magnetic strips in each corner. Because the magnetic board is hard, it can be used to make drawings using swell paper or relief paint, but not for a tracing wheel on a file pocket, which requires a softer surface to make an indentation in the plastic.

### Cardboard and clips

You can use binder clips or paperclips to keep different layers in place on a baseboard. A piece of cardboard may be good enough to make a temporary baseboard (the cardboard is easily damaged, so does not last very long). Several pieces of cardboard on top of each other are thick enough to hold pushpins without scratching the surface underneath.



You can use paperclips or binder clips to hold paper to a piece of cardboard.



### 2.7.2

#### Measuring lengths: Tape measures

Useful for: Blind, Low vision

You can buy tactile tape measures with studs at centimetre (or inch) intervals. You can also make your own (less durable) version from a strip of cloth or paper, or by adding staples to a paper tape measure from a home-improvement store. Put two staples every 5 or 10 centimetres.



Tactile tape measures: homemade and commercial.

You can also use scissors or a sharp knife to cut notches every centimetre into a normal tape measure. Make a larger notch (or add a stud) every 10 centimetres.

### 2.7.3

#### Drawing lines and measuring lengths: Rulers

Useful for: Blind, Low vision

See **Part 3: Drawing** for ideas on how to draw:

- Parallel lines
- Shadows
- Lines of sight.

#### Drawing lines

Students can use a ruler or straight edge to draw lines. To hold the ruler in place, use two pushpins, one at each end of the line, and press the ruler against them.

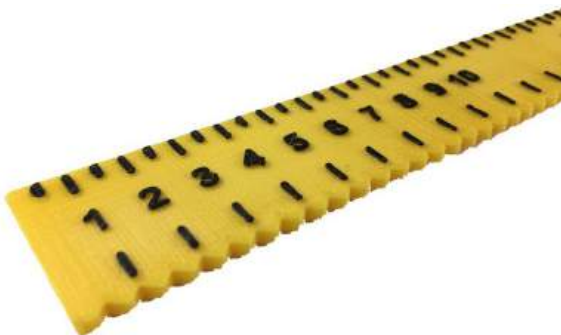

A ruler with a straight edge for drawing lines, a notched edge for placing pins, and tactile marks.

### Adapting a ruler

You can make a ruler for a blind student from a standard ruler. It must have the following characteristics:

**Make tactile marks** at every centimetre/inch. Tactile marks on top of the rule are better than indentations because they are easier to feel. You can make them with relief paint, glue or candle wax.

**Make special marks** (e.g., elongated stripes) every 5 centimetres to speed up the reading.

**Make special marks** (e.g., dots) every half centimetre to improve accuracy. Allow blind and visually impaired students larger error margins than sighted students.

**Start at 0** so the student can align the left end of the ruler to the left end of the object to measure and does not have to align the zero mark.

**Make it thin.** The thinner the material is, the closer the marks are to the object that the student is measuring and the easier it is to read the correct length. It helps too if the ruler tapers towards the edge, just as with rulers for sighted users.

**Indentations in the edge** every centimetre let the student feel a dent as their pen goes past it. This way the student can count the number of dents the pen has passed and so count the length of the line they are drawing.

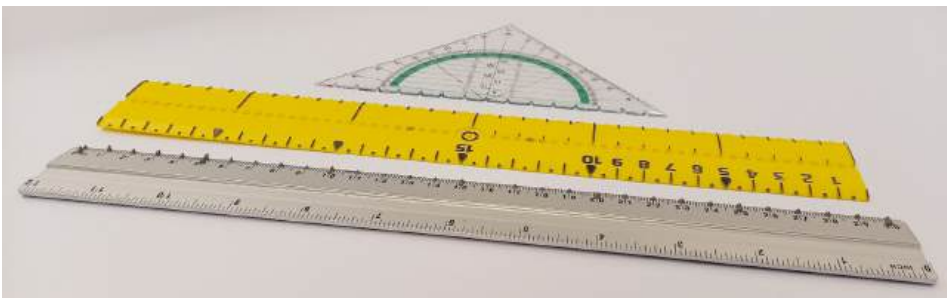

Tactile and high-contrast rulers and a tactile set square/protractor.

### Making a ruler from a plastic sheet

You can use a sharp knife or pair of scissors to make a ruler from a piece of plastic sheet. Cut notches in the edge every centimetre. Use a slate and stylus to add braille numbers, and a felt pen to add regular numbers.

Instead of notches, you can mark each centimetre with an embossed braille dot. Put two dots every 5 centimetres.

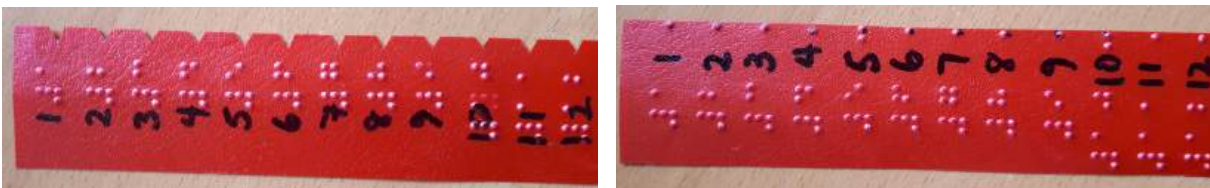

Homemade rulers with braille numbers.

### Making a ruler with a 3D printer

See **More information** for sources of ready-to-print files.

### Buying rulers

See **More information** below for where to buy tactile rulers.

#### 2.7.4

### Drawing parallel lines: Foldable parallelograms

**Useful for: Blind, Low vision, Sighted**

A foldable parallelogram can be used to draw parallel lines. See **Part 3: Drawing** for a step-by-step description on how to do this.

The foldable parallelogram in the pictures has length 18 cm for the long sides and 7 cm for the short sides. You use the long sides to draw along. There is no maximum length for the long sides. You use the short sides to set the distance between the two parallel lines. With short sides of 7 centimetres, students can draw parallel lines that are 0 to 7 centimetres apart. If the short sides are longer than 7 centimetres, the deformation of the parallelogram makes it hard to position it in such a way that it is both along the original and the parallel line.

A foldable parallelogram is easiest to work with if it is thin: the material of the parallelogram should be close to the paper. You can make one from steel, Meccano, card or wood. Metal is best as it is rigid and durable; card is flimsy and easily damaged.

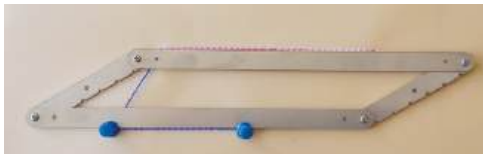

Foldable parallelograms made from laser-cut stainless steel (top left), Meccano (right) and card and split pins (bottom left).

#### 2.7.5

### Drawing polygons

**Useful for: Blind, Low vision, Sighted**

Make triangles, squares, circles, etc. out of card or foam for the student to draw around. Use pushpins or magnets (for thin card) to hold the shapes in place.

You can buy commercial tactile set squares.

To draw polygons, put pushpins where the corners are to go, then hold a ruler against them and draw along the straight edge.

### 2.7.6

#### Drawing circles

Useful for: Blind, Low vision, Sighted

#### Circular objects

You can collect jar lids, coins and washers of various sizes to use directly, or to draw around. Make a hole in the centre of the lid or card, and use a pushpin to fix it to the pinboard.



You can use lids, coins and washers as circles.

#### Beam compass

The easiest way for students to draw a circle is with a rod or beam with holes in it. Fix one end of the rod with the pushpin on the pinboard. This will be the centre of the circle. The pen or pencil goes through one of the other holes. Turn the rod with the pen, and the pen will draw a circle. See **More information** for a video.

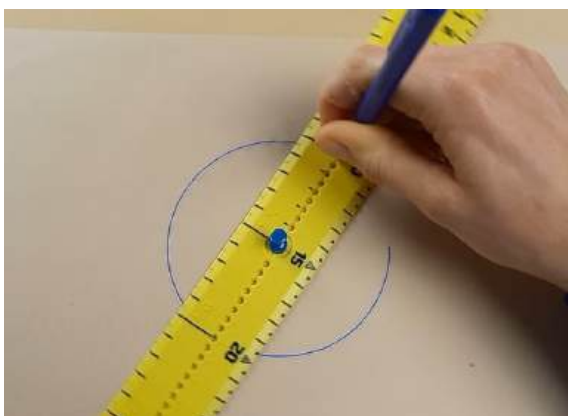

Drawing a circle with a beam compass.

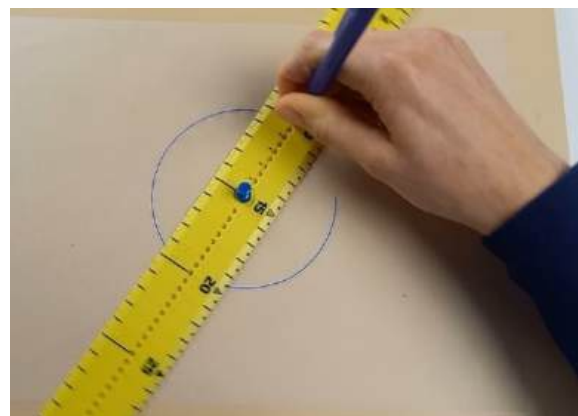

A ruler with a series of holes down the middle can be used to draw circles.

### Making a beam compass

A beam compass is easy to make from wood, firm cardboard, or plastic. Use a material that is 2 to 4 mm thick. Thinner materials will bend; thicker materials are hard to fix with the pushpin.

Make a small hole (diameter is 1.5 mm) in one end for the pushpin.

Make a series of holes at regular intervals – at least 2 mm in diameter for thin materials and up to 4 mm for thicker materials. For beginners, use holes that are 1 cm apart. For more advanced students, make holes that are 0.5 cm apart. You can use relief paint, glue or candle wax to mark the holes at the full centimetre distances.

### Making a beam compass with a 3D printer

You can 3D-print a beam compass. See **More information** for details.

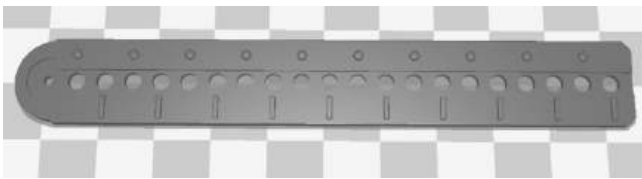

A beam ruler made with a 3D printer.

### Regular compasses

#### Useful for: Blind, Low vision, Sighted

Blind and visually impaired students usually have more difficulties working with a regular compass than sighted students. This is mainly because they have problems rotating the compass and putting enough pressure on the pencil without pushing the legs towards each other. This problem does not exist if the legs of the compass can be fixed in place. The brand Maped makes compasses with fixable legs.

Different mechanisms exist to fix the legs at a set distance:

- The legs of the Maped Precision are adjusted with a wheel.
- The Maped Stop System has a red lever; you can adjust the legs only if the lever is flipped towards you.
- The Maped Stop System Innovation has a red lever; you can adjust the legs only if you push the lever against the legs.

All three compasses have the option to replace the pencil with a holder for a pen or marker. That makes these compasses ideal for students with low vision.



Left: Precision; middle: Stop system; right: Stop system innovation

### 2.7.7

#### Measuring angles: Protractors

##### Useful for: Blind, Low vision

A standard protractor can easily be adapted for blind and visually impaired students. For students to use it to measure angles, they need tactile drawings. See **Drawings and graphs** for ways of making tactile drawings.

##### Making a protractor

You can make a protractor for blind students from a standard protractor, or you can use cardboard or wood to make one from scratch.

A protractor for blind students must:

**Have tactile marks at every 10 degrees.** Tactile marks that on top of the protractor are better than indentations because they are easier to feel.

Special marks (e.g., elongated stripes) at every 90 degrees make the reading easier.

Special marks (e.g., dots) at every 5 degrees improve accuracy (although blind and visually impaired students should be allowed larger error margins than sighted students). A disadvantage of a protractor with 5-degree marks is it must be quite large (a diameter of at least 12 cm) in order to distinguish the marks. A bigger protractor works only with larger drawings.

**Be thin.** The thinner the material is, the closer the marks are to the object that the student is measuring and the easier it is to read the correct length.

**Have a positioning aid** to help the student place it over the vertex. This may be a slit or a hole.

You can **3D-print** a protractor. See **More information** for details.

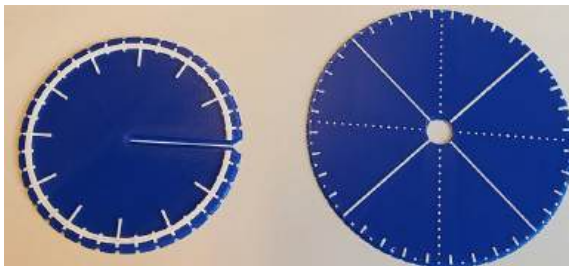

Two types of protractors: with a slit and a hole.

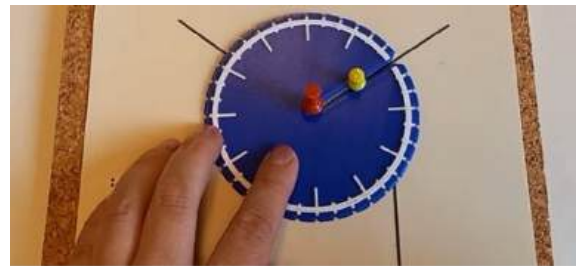

Protractor with a slit.

A **protractor with a slit** is used with two pushpins. The student places one pushpin in the vertex and the other pushpin in one of the rays of the angle to be measured. The first pin centres the protractor over the vertex. The second aligns the zero of the protractor over the ray.

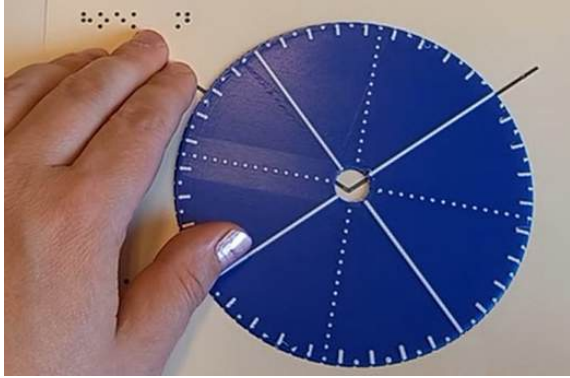

Protractor with a hole.

The hole in the middle of a **protractor with a hole** should be 1.5–2 cm in diameter. The student positions the protractor with the centre of the hole over the vertex. Holding the fingers on the vertex and rotating the protractor with the other hand, the student aligns the zero of the protractor over the ray to be measured.

### Using a protractor

The protractor is always used in combination with a diagram of an angle. Make sure the rays of the angle (or the sides of the triangle or other figure) are at least 1 cm longer than the radius of the protractor. Blind students cannot see the lines to measure through a transparent protractor. They depend on the portion of the line that extends beyond the protractor, so the lines should be longer than the protractor radius.

Help the student practise how to position and read the protractor. See **Part 3: Plane geometry** for how to do this.

### More information

#### 3D-printing

Medien Augenbit. <https://medien.augenbit.de/category/mathematik+modelle/?lang=en>  
(click Older Posts to see more items; website partly in German)

Tactiles. [https://tactiles.eu/?sfid=130&sf\\_s=math](https://tactiles.eu/?sfid=130&sf_s=math) (website partly in German)

#### Buying online

APH. [https://www.aph.org/search-results/?fwp\\_search\\_term=math](https://www.aph.org/search-results/?fwp_search_term=math)

EduVIP. <https://www.eduvip.nl/product-categorie/rekenen-wiskunde/>

Maxiaids. <https://www.maxiaids.com/category/s?keyword=math>

RNIB. <https://shop.rnib.org.uk/education/curriculum-subjects/stem>

Senso-care. <https://senso-care.nl/ontwikkelingsgericht-speelgoed?cat=1011>

Senso-care ruler. <https://senso-care.nl/desk-buddy-tactiele-liniaal?sqr=liniaal&>

Visibility. <https://livingaids.com.au/products/ruler-tactile-30cm?pos=1&sid=a28b7ee9d&ss=r>

#### Compasses

Video on using a beam compass: <https://medien.augenbit.de/wp-content/uploads/2014/12/Blindenzirkel.mp4>

#### Protractors

How to use a protractor (in Dutch): [https://youtu.be/xXkkpv\\_G9AY](https://youtu.be/xXkkpv_G9AY)

## 2.8 3D objects and models

### 2.8.1 3D geometric shapes

**Useful for:** Blind, Low vision, Sighted

Geometric shapes can be made from card, clay, wood or wire, printed using a 3D printer, or bought online.

**Card.** You can make your own solid shapes out of card and sticky tape. Make them small enough to hold in one hand.

**Wooden or clay blocks.** Children's building-block toys have some of the shapes you need. Get a carpenter to make the rest.

**Clay or plasticine.** You can make shapes out of:

- **Clay.** After making the shapes, you can dry them and bake them in an oven to make them hard.
- **Plasticine** (modelling clay) or Play-Doh. These are commercial products that stay soft so can be remoulded many times. If it is allowed to dry, Play-Doh goes hard and makes permanent shapes.
- **Home-made playdough.** Make this from 1 cup of wheat flour, half a cup of salt, and half a cup of water. Mix together to make a kneadable mass. Add food colouring to make different colours. After making the shapes, bake them in an oven to make them hard and more durable. See **More information** for a video.

**Everyday objects.** You can make a collection of everyday items to illustrate geometrical shapes. A ball is a sphere. Make a cone out of paper or card.



You can buy sets of geometrical blocks  
– or get a carpenter to make them.



Shapes made from plasticine.



Make a collection of everyday items to illustrate geometric shapes.



**Wire models** are especially useful when teaching space diagonals (also called body diagonals or interior diagonals) or when working with a 3D coordinate system. You can make them yourself from stiff wire. Use thin wire, solder (or even wine gums!) to keep the models together.

**3D printer.** If you have a 3D printer, you can find ready-to-print-designs for geometrical shapes here:

**Magnetic tiles** are shapes with magnets built into their edges.

**Magnetic sticks and balls** can be combined into different 2D and 3D shapes. Because they form open shapes, they can be used to explain interior angles and measurements.

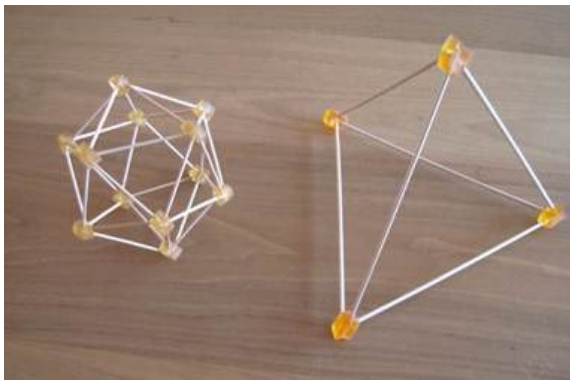

3D wire models, held together with wine gums.

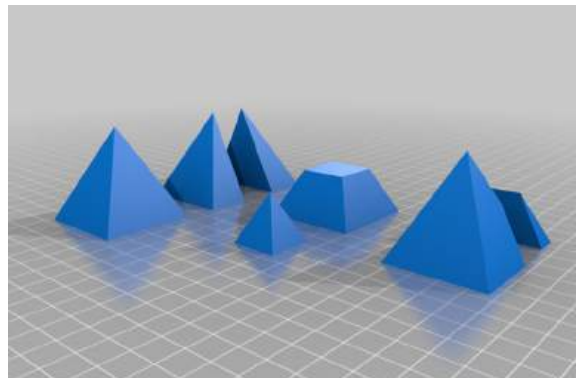

Cross-sections of a pyramid made with a 3D-printer. From left to right: intact pyramid, vertical cross-section through apex (triangular cross-section); horizontal cross-section (square); vertical cross-section not through apex (trapezium).



Magnetic tiles.

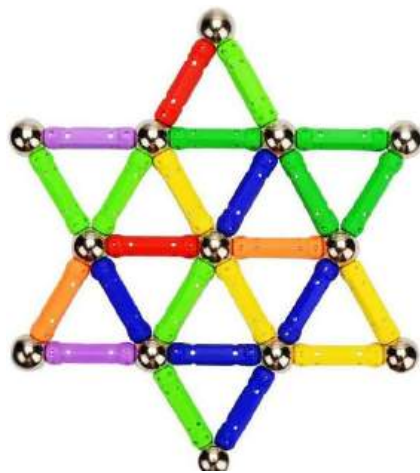

Magnetic sticks and balls.

**Purchase online.** You can buy various sets of shapes online. Search for **geoblocks**, **geometric shapes**, or **geosolids**. Some sets also include nets (see next section).

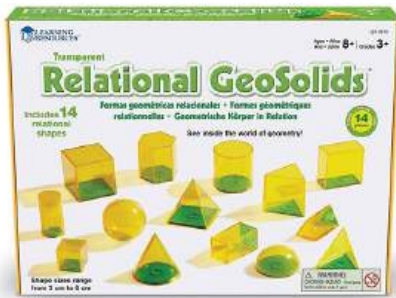

Commercial geosolids.

### 2.8.2

#### Nets

**Useful for: Blind, Low vision, Sighted**

Nets are two-dimensional shapes that can be folded to form three-dimensional solids. You can make your own nets from card or buy commercially available sets.

Some guidelines if you make your own:

- Use a fairly rigid material to make the nets, such as cardboard, wood or plastic. If you use paper, laminate it to make it stiffer and more durable. Score along the folds to make it easier to fold the nets correctly.
- For curved surfaces (cones, cylinders) you will need a material that can be shaped. Use adhesive tape to keep the folded net together.
- The faces should be connected in a way that facilitates folding, e.g., adhesive tape or hinges.
- The material for the faces should have a certain thickness, so that the ends touch when the shape is folded.

You can make both correct nets (which can be folded into a solid shape) and incorrect nets (which cannot).

#### Shapes needed

To teach nets you will need foldable examples of the following geometric shapes:

- **Cube or cuboid:** the net consists of 6 faces, all rectangles (or squares)
- **Cylinder:** the net consists of three faces: one rectangle and two circles.
- **Pyramid:** the base may be triangular, rectangular, another polygon, or a circle (forming a cone)
- **Prism:** the base may be triangular, rectangular, another polygon, or a circle (forming a cylinder)



Some sets of geosolids include nets. The shapes can be filled with grain or water to measure volumes.

Examples of nets

Make tactile drawings of these nets, for example with a tracing wheel.

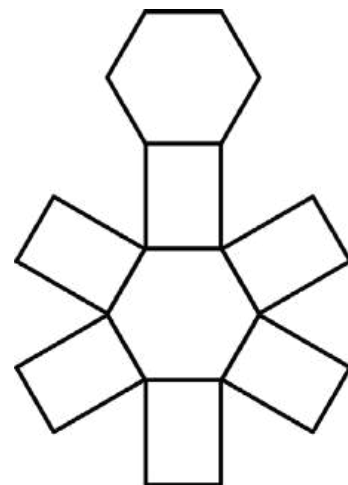
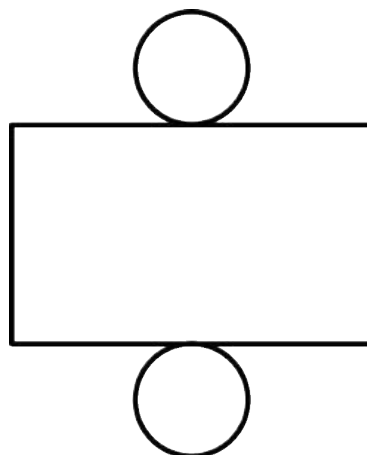
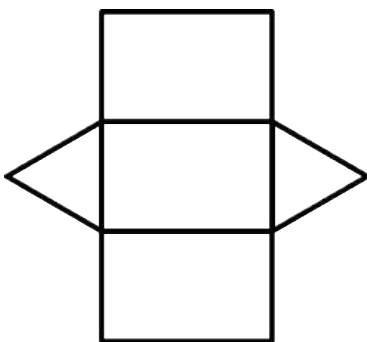
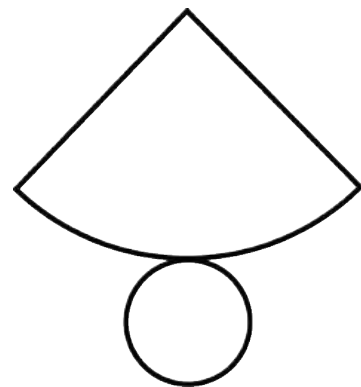
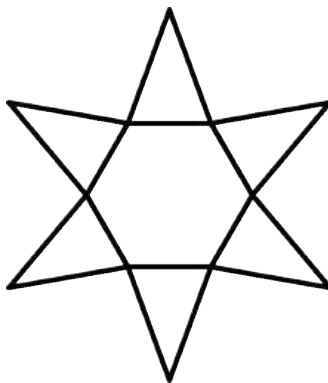
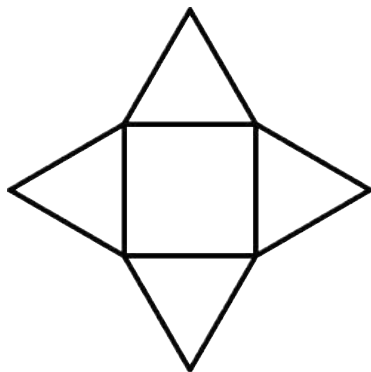
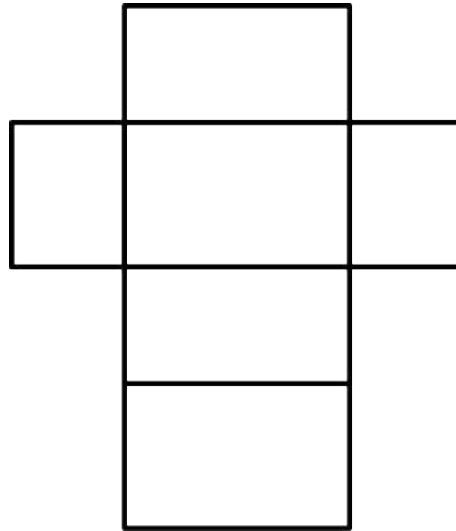
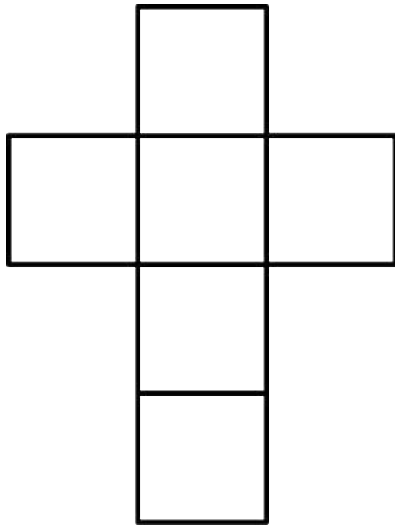

Nets to trace

Cube, sides 4 cm

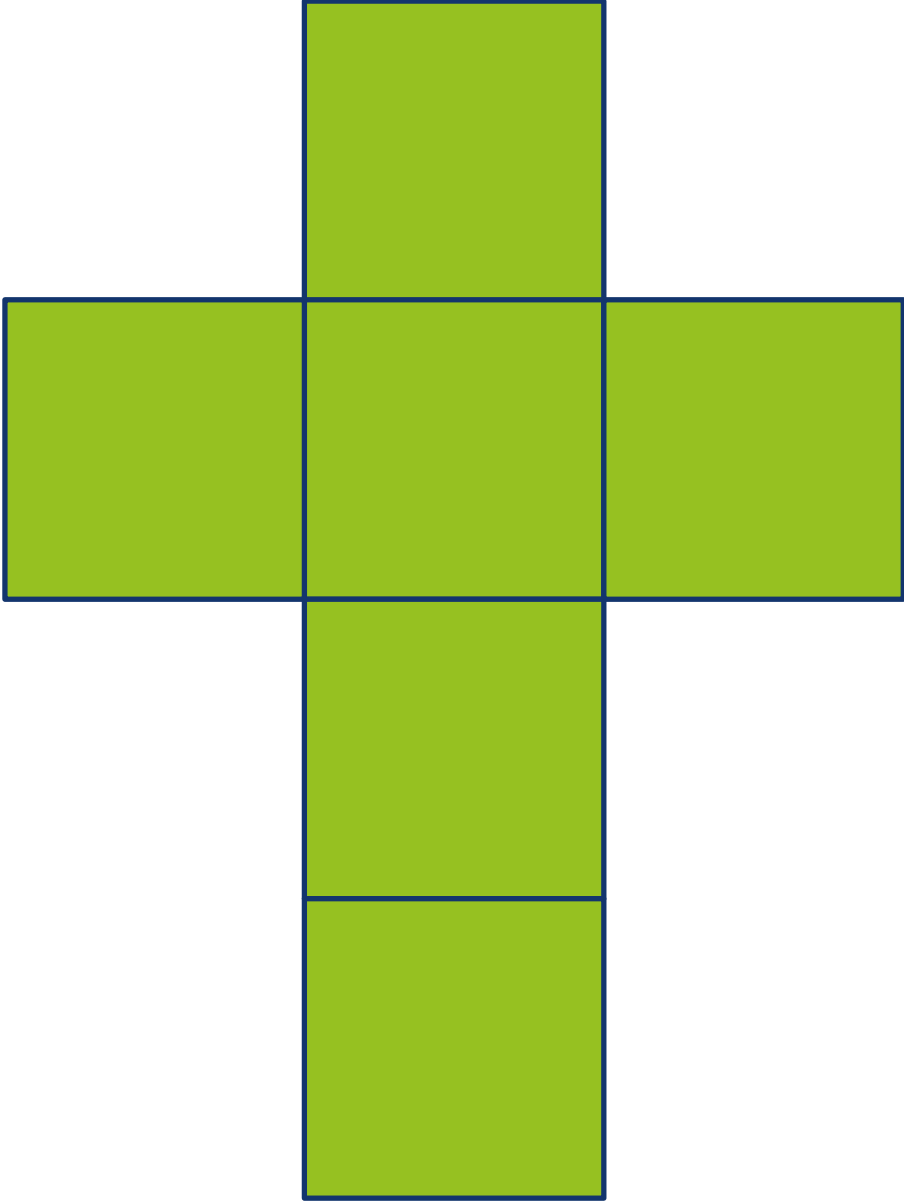

Cube, sides 2cm

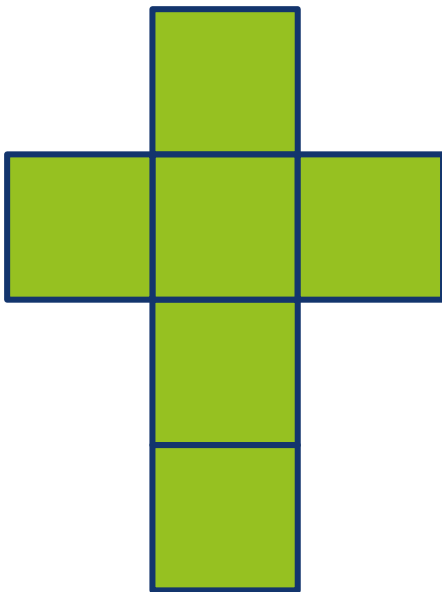

Cubes, sides 1 cm

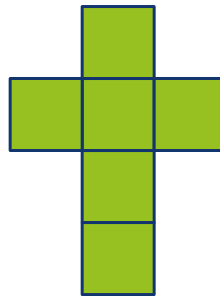

Cuboid, sides 2 \* 2 \* 4 cm

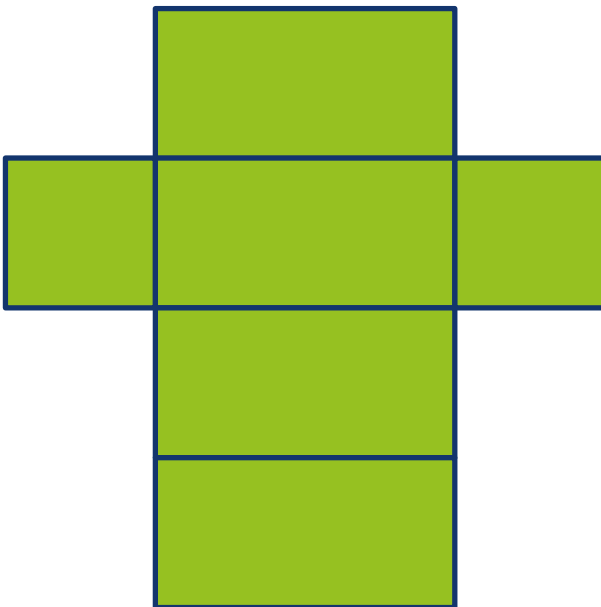

Cuboid, sides 1 \* 2 \* 4 cm

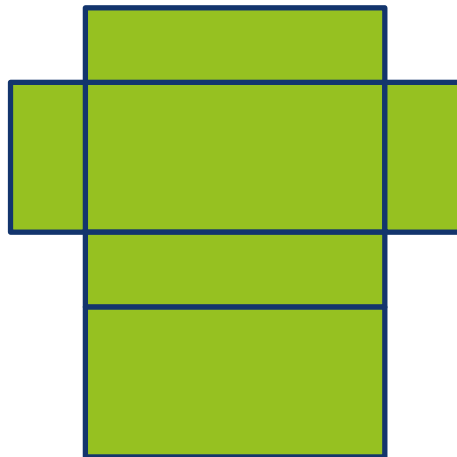

Cylinder, 4 cm high, diameter 4 cm

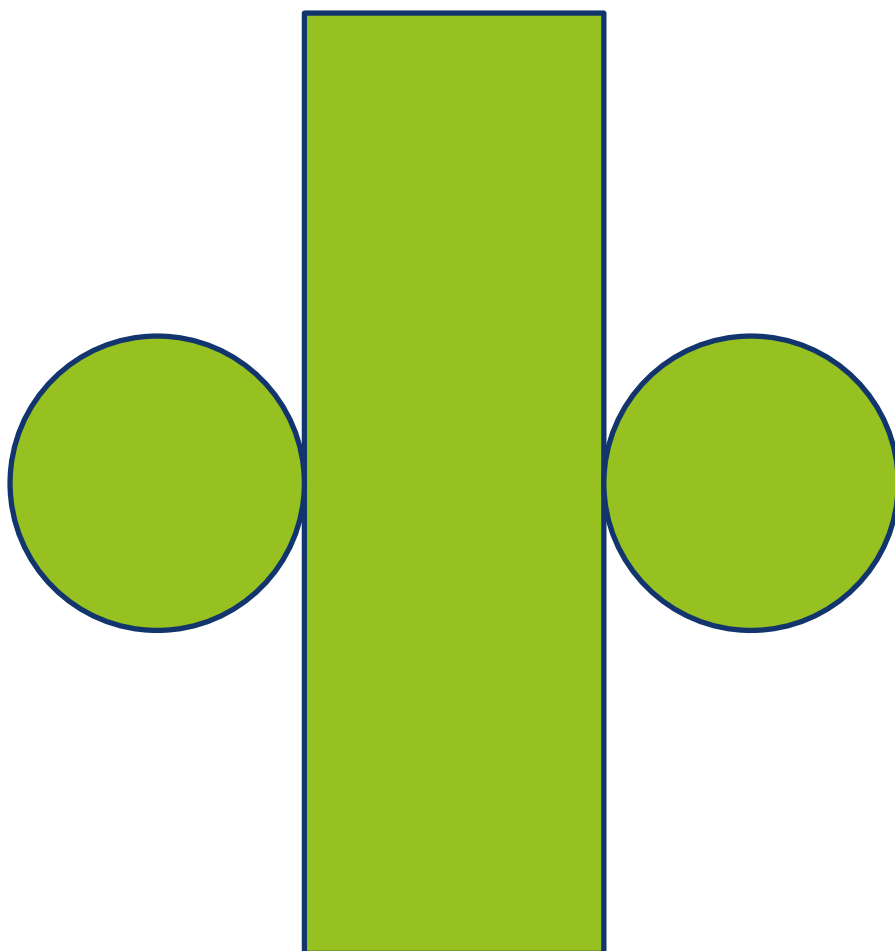

Tetrahedron: length of sides 4 cm

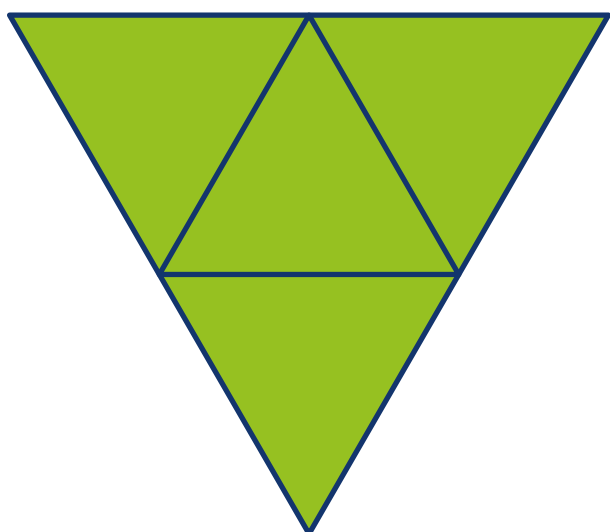

Square-based pyramid, base 4 \* 4 cm.

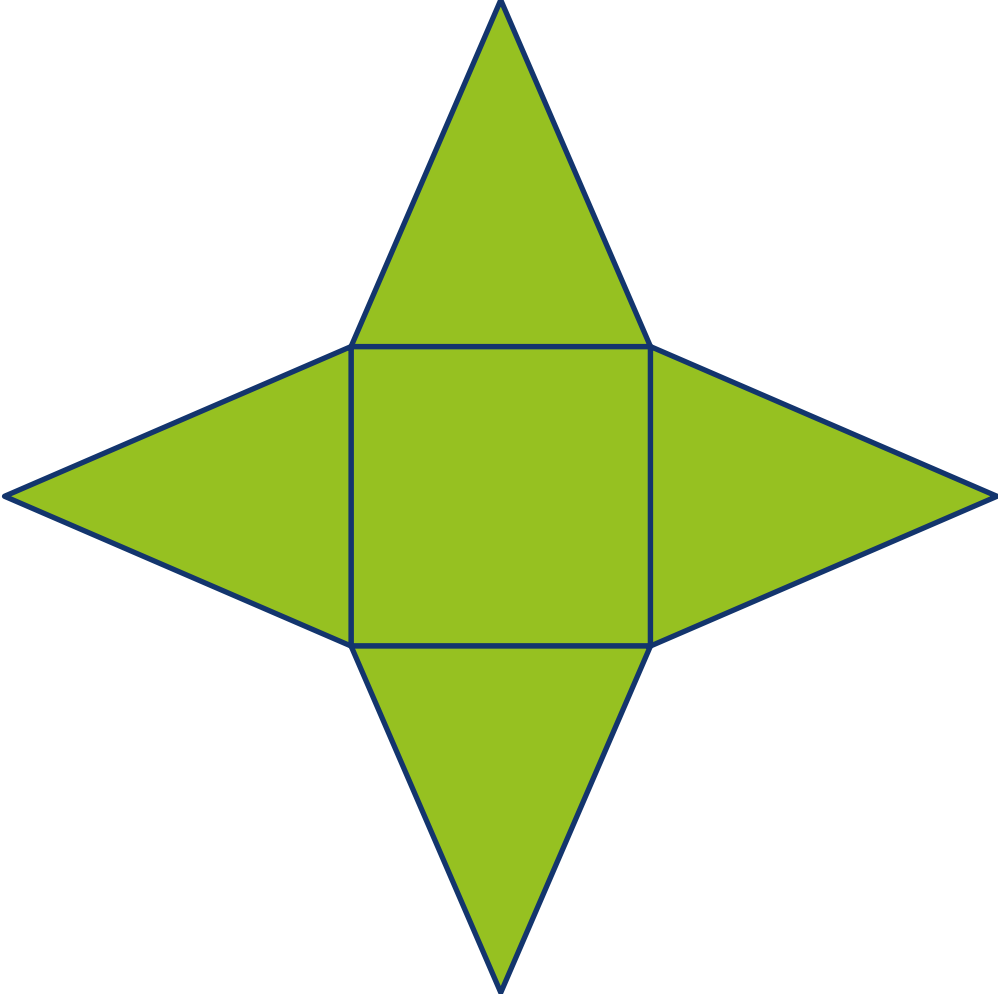

Right triangular prism

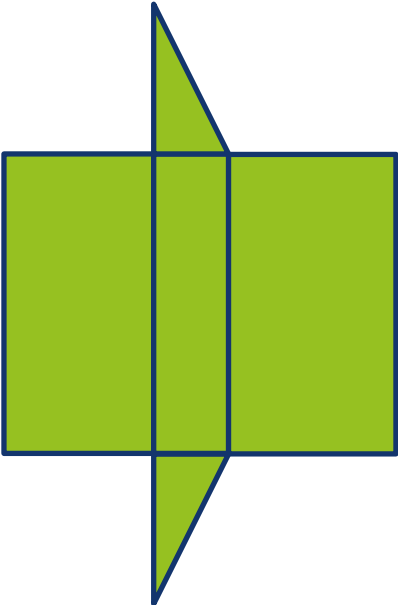

Cone: diameter 4 cm, angular height 8 cm

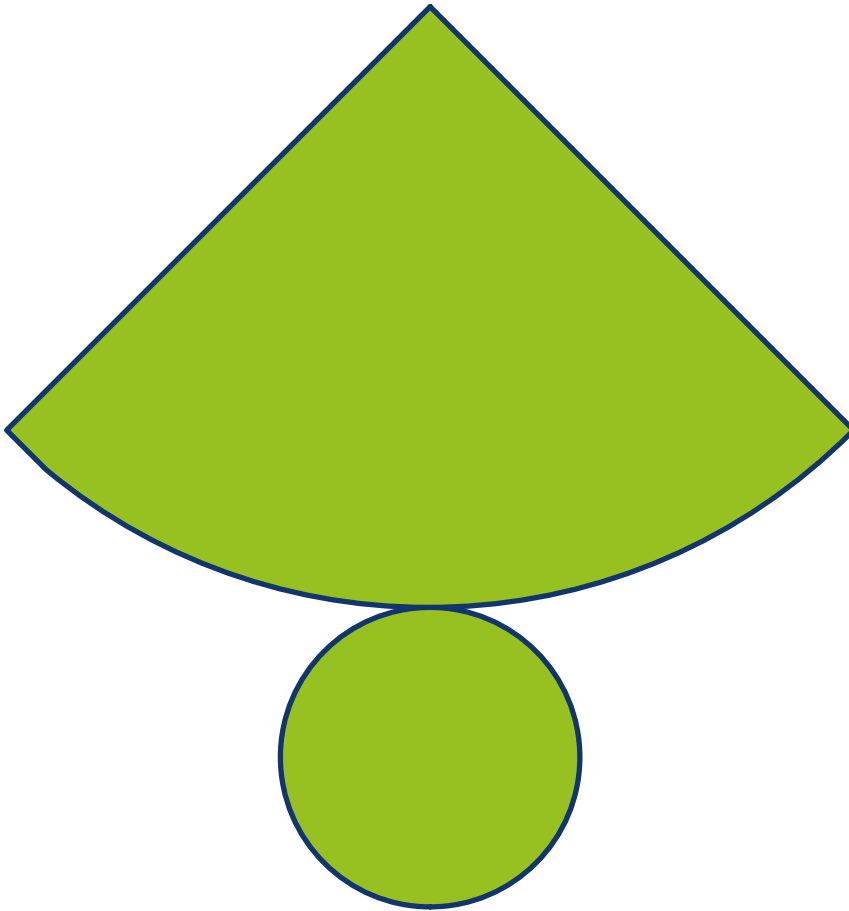

### 2.8.3

#### Projections

Useful for: Blind, Low vision

To work with projections, students need two types of materials:

- Materials to build a 3D structure
- Materials to represent the 2D top, front and side views.

Lego blocks are useful to build 3D structures. Because they can be attached firmly to each other, the learner can tactilely explore the structure. The structures can be attached to a Lego baseplate. To make permanent shapes, glue Lego bricks together.

You can use various methods for the 2D views:

- Marker on paper (for students with low vision)
- Pushpins on a grid made from swell paper, file pocket, etc.
- Lego, geoboard, magnetic board, cardboard, etc.
- Relief paint
- Velcro and wool
- Braille: build up diagrams by repeating the braille sign ⠠⠠ as many times as required to depict the projection.

See **Drawings and graphs** for more ideas.



### 2.8.4

#### Magnification factors

Useful for: **Blind, Low vision, Sighted**

It is difficult for blind or visually impaired learners to feel that two shapes or objects of different sizes have the same shape. This is especially true if the shapes or objects are oriented differently – if one is upside down, for example. Fixing them to a baseboard makes this easier to detect.

To count the sides or faces, the learner can mark each one with a dot or a piece of sticky tape.

Ideas for solid objects:

- Collect tin cans of different sizes. Smooth off any sharp edges before using them in class.
- Collect boxes and balls of different sizes.
- Stick small magnets to solid objects (such as cubes) to build them up into more complex shapes.
- Build solid shapes out of Lego.
- Get a set of matryoshka dolls.

You can fill tin cans, boxes or matryoshka dolls with a grain such as rice (or perhaps with water) to demonstrate that volume increases cubically with the length of the object. The thickness of the material (and the shape of the box or can) will affect the accuracy of the measurement, but it still works as an illustration.



Children's nested toys can be used to demonstrate volumes.

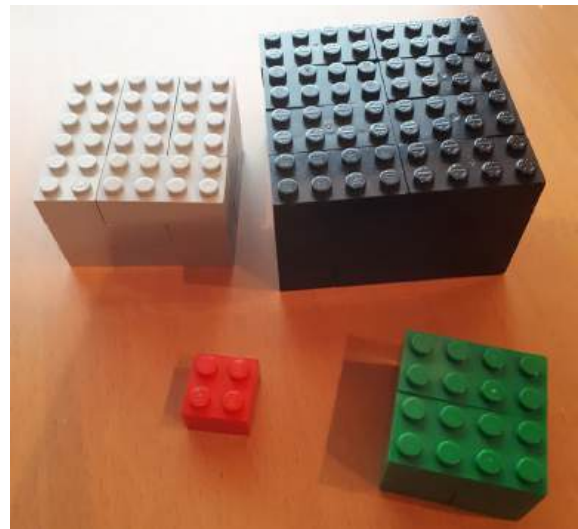

Lego blocks to illustrate volumes.



Matryoshka dolls can be used to illustrate concepts of magnification and volume.

### More information

APH Tactile graphic image library. Geometry. (Requires free registration; uses Nemeth notation)

<https://imagelibrary.aph.org/portals/aphb/#category/85>

How To Clay. Surprisingly easy way to make 3D basic shapes out of clay!

<https://www.youtube.com/watch?v=Oka-sK7rqvg>

Learning Resources. <https://www.learningresources.com/catalogsearch/result/?q=geometry>

Lehrerwelt. <https://www.lehrerwelt.de/marken/learning-resources>

Medien Augenbit. <https://medien.augenbit.de/category/mathematik+modelle/?lang=en>

(click Older Posts to see more items; website partly in German)

Morkka. Magnetic building blocks.

<https://www.amazon.de/stores/page/4748452A-C163-4136-BA3C-3492151BBBA3>

Perkins School for the Blind. Teaching geometry using magnetic tiles.

<https://www.perkins.org/resource/teaching-geometry-using-magnetic-tiles/>

Sea Lemon. How to make play dough - Easy no cook recipe!

<https://www.youtube.com/watch?v=oAlAm6BFOfs>

Thingiverse. Math under your fingertips 3D models. [thingiverse.com/thing:4885644](https://www.thingiverse.com/thing:4885644)

Willings, C. Teaching students with visual impairments: Geometry & spatial adaptations.

<https://www.teachingvisuallyimpaired.com/geometry--spatial-sense.html>

## 2.9

### Abacus

Useful for: Blind, Low vision, Sighted

The abacus is used as a children's toy, a teaching device in kindergartens and primary schools, and a calculation device in many countries, especially in Asia. It is very useful for blind and visually impaired people, both in learning mathematics and for everyday calculations.

#### 2.9.1

##### Types of abacus

An abacus consists of a rectangular frame with a series of rods, each carrying a number of beads.

There are various types of abacus. All of them can be used for teaching.

**Toy abacus.** In the simplest form, often found as toys, each rod has 10 beads, which are moved horizontally. The number of beads denotes the number, while the rod shows the magnitude (units, tens, hundreds, etc.)



Toy abacus with 10 beads per rod, set to show 346.

The **Chinese abacus** has seven beads on each rod: two above a dividing bar, or “beam”, and five below it. Numbers are shown by moving beads to the beam: each bead below the beam counts as 1, while each bead above the beam counts as 5. The abacus is placed flat on a table to prevent the beads from moving.

The **Japanese abacus** is similar to the Chinese abacus but has five beads on each rod: one above the bar and four below. Like the Chinese version, each bead below the bar counts as 1, while each bead above it counts as 5

The **Cranmer** abacus is an adaptation of the Japanese version for people with impaired vision. It has a felt backing to hold the beads in place once they have been set, and tactile marks on the frame to make it easier to detect which rod is which.

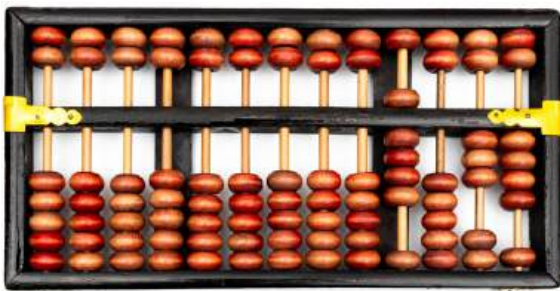

Chinese abacus (with 7 beads on each rod), set to show 9034.

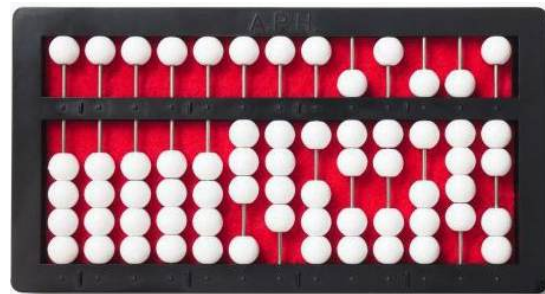

A Cranmer abacus has 5 beads on each rod. The red felt backing prevents the beads from moving once they have been set in position. This abacus is set to read 34,172,692.

### 2.9.2

#### Introducing the abacus

Give the learner the abacus and let them explore it with their fingers. Help them understand the number of rods and beads, the meaning of the separating bar, and any tactile marks.

Start with simple counting. Show the learner how to count items and set numbers. Then move to addition and subtraction of single-digit numbers, followed by larger numbers. If possible, do this at the same time as teaching these arithmetic skills in the class.

After that, you can go to more complicated skills, such as multiplication, division and work with fractions.

The learner can use the abacus as a tool for computation and use a braille to record the answers. Or they can use the abacus to show the teacher their answer, eliminating the need for a braille for some exercises.

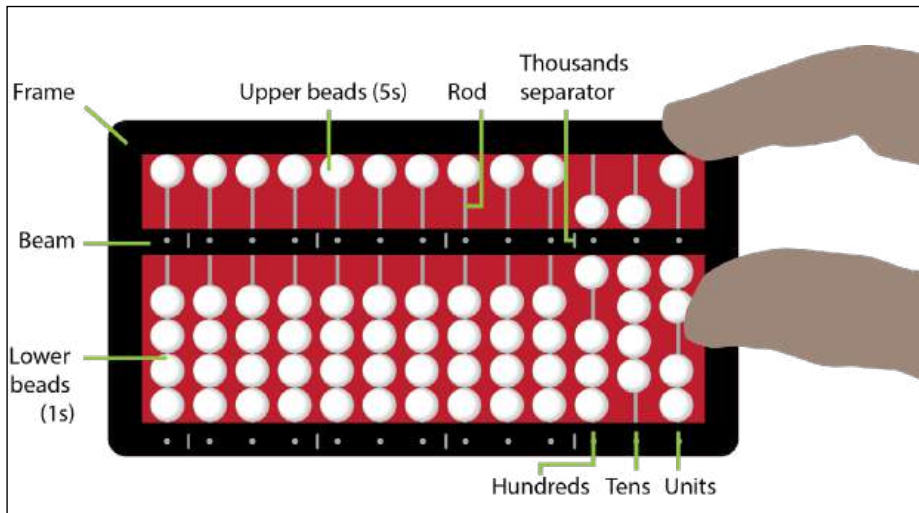

Parts of a Cranmer abacus, set to show 692.

### 2.9.3 Using the abacus

The numbers are normally set with the units on the far-right hand rod, the tens on next rod to the left, the hundreds on the next rod, and so on. The abacus has tactile dots on the beam (the separator bar) to mark each rod, and longer tactile lines every three rods to mark the thousands, millions, and so on, in the same way commas are used to separate long numbers into groups of 3 digits.

To allow calculations with a decimal point, the numbers can all be shifted several rods to the left. The remaining rods on the far left can be used to note numbers to use in a sum, fractions, or results of the sum.

The abacus can be used either way up: with the 5s beads either furthest from the user (as in the photo above) or the other way up, closest to the user.

The index finger of the right hand is used to set the 5s beads, and the thumb is used to set the 1s. Moving the beads to the beam is called "setting". Moving them away from the beam is called "clearing".

To set a number, move the required number of beads to the beam.

- To set the number 2, move 2 beads on the rightmost rod to the beam.
- To set the number 90, on the second rightmost rod move 4 lower beads to the beam, as well as one upper bead.
- To set the number 600, on the third rightmost rod, move 1 of the lower beads and 1 upper bead to the beam.

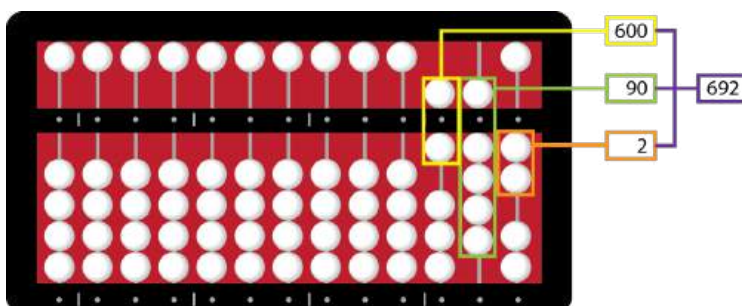

Cranmer abacus set to 692.

The abacus can be used to perform addition, subtraction, multiplication and division, as well as finding factorials, calculating with fractions and decimals, using negative numbers, etc.

See the videos listed under **More information** for instructions on how to use the abacus.

### More information

#### Instructions

Abacus made easy. Simplified manual for teaching the Cranmer abacus. Downloadable manuals. APH.

<https://www.aph.org/product/abacus-made-easy/>

Heffelfinger, T. 2003. Square roots: <http://totton.idirect.com/soroban/KojimaSq/>

Heffelfinger, T. and G. Flom. 2004-18. Abacus: mystery of the bead. The bead un baffled - An abacus manual.

<http://totton.idirect.com/abacus/pages.htm#Soroban1>

ICEVI, Overbrook School of the Blind, and Nippon Foundation. 2005. Mathematics made easy for children with visual impairment. ON-NET and ICEVI.

Millaway, S.M. Abacus basic competency: A counting method.

<https://www.aph.org/product/abacus-basic-competency-a-counting-method-large-print/>

Texas School for the Blind and Visually Impaired: Abacus <https://www.tsbvi.edu/abacus>

Willings, C. 2019. Cranmer abacus instruction.

<https://www.teachingvisuallyimpaired.com/cranmer-abacus-instruction.html>

#### Video

##### The Cranmer abacus

Introduction: <https://www.youtube.com/watch?v=mmatTQ5hynw>

The counting method of addition & subtraction: <https://www.youtube.com/watch?v=QYmrKfcKIJY>

Indirect method of addition and subtraction: <https://www.youtube.com/watch?v=87XgMwl9ZQo>

Fractions and decimals: <https://www.youtube.com/watch?v=Xzd6KIEco3I>

##### Abacus classes by Pranaii

Multiplication: [https://www.youtube.com/watch?v=0eFDgaG\\_9Qg](https://www.youtube.com/watch?v=0eFDgaG_9Qg)

3 digit x 2 digit multiplication abacus. <https://www.youtube.com/watch?v=kXDYOa2N8vQ>

Division: <https://www.youtube.com/watch?v=O2lGQh94gfM>

4 digit by 2 digit division: <https://www.youtube.com/watch?v=DZBcdB7iQM5>

##### Buy

Cranmer abacus. <https://www.aph.org/product/cranmer-abacus/>

## 2.10

### Calculators

Useful for: Blind, Low vision, Sighted

Calculators can be an important part of mathematics teaching, especially in the more advanced topics such as trigonometry and logarithms. Learners can use them to perform calculations quickly and accurately that they would find difficult or impossible using other methods. This is also true for blind and visually impaired learners.

Calculators range from basic (with only the basic arithmetic functions) to scientific (with features such as memory, trigonometry, logarithms and statistics).

- **Talking** calculators read out the input and output.
- **Graphing** calculators can display graphs.
- **Printing** calculators have a roll of paper to print out the calculations.

Make sure the functions match the needs of the student and the level of mathematics taught.

Some visually impaired learners can, with some help and adaptations, use the same calculator as sighted classmates. But most visually impaired students need a device that is adjusted to their specific needs.

No matter what device they use, a blind or visually impaired student will need more help than a well-sighted student to learn how to use it. Plan time for individual instruction for every new function of the calculator you introduce.

The linear notation (the sequence of characters) used in some calculators is different from that used in braille. This means the learner may have to learn two different notations.

#### 2.10.1

##### Considerations when choosing a calculator

Useful for: Blind, Low vision

Some schools, and some learners, do not have calculators. If the sighted learners have them, then the blind and visually impaired students should also learn how to use them.

Students with low vision may be able to use a calculator with the help of a magnifying glass.

If the student has a smartphone or tablet, check the accessibility options, visibility enhancements and magnification options. Go to the device's Settings to change these.

Computers, tablets and smartphones come with pre-installed calculators, but there may be more suitable alternatives. Consider downloading a calculator app with a high-contrast colour scheme, instead of the pre-installed calculator.

Consider using a talking calculator (though these are expensive). The student can use earphones to avoid distracting their classmates.

Note that the order of keystrokes may be different with different calculators.

### More information

Vision Australia. Calculators.

[www.visionaustralia.org/information/adaptive-technology/using-technology/calculators](http://www.visionaustralia.org/information/adaptive-technology/using-technology/calculators)

### 2.10.2

#### Adjusting a regular calculator

##### Useful for: Low vision

Even if they cannot read the keys, a visually impaired student can use a regular hand-held calculator if they can read the answers on screen. Here are some ways to make a regular calculator easier to use.

A **magnifying glass** and **good lighting** may help the student to read both the screen and keys. Some calculators are easier than others for visually impaired students to use. See below for tips on choosing a calculator for visually impaired learners.

#### Finding a key

Visually impaired students may find it difficult or impossible to find a specific key. Whenever you introduce a new mathematical function (such as square root), **give clear instructions on where to find the key and how to use it:**

“Start with your finger on the key in the top left corner. Move two keys to the right (pause) and three keys down (pause). This is the key for the square root. If you press this key, a square root symbol will appear on screen, followed by a bracket. Type the number (or the expression) from which you want to take the square root and conclude with a bracket before you press the equals key.”

#### Making keys easier to find

If the keys are hard or impossible to read, try these tips.

Use **coloured paint** to distinguish between different types of keys (you can use any colours you have available, as long as they are easily distinguishable).

- Put yellow paint on the number keys.
- Put red paint on the operator keys: + - / \* =
- Put blue paint on the on/off switch and on frequently used mathematical functions, such as square, square root, sin, cos, and tan.
- Do not put paint on the other keys.

With the paint on the keys, the student will no longer be able to read the keys, so they must memorize the position of the keys. Spend some time explaining where to find a key and to help the student memorize it, or ask a fellow student to help.

Mark often-used keys with **tactile clues**, such as dots or lines made with glue. Keys that are important to mark in this way:

- On/off
- =
- Shift key (the key that switches the functions of the keys from  $^2$  to  $\sqrt{\quad}$  and from **sin** to **arcsin**)
- Mathematical functions that are often used but hard to find, such as square and square root.

### Reading the screen

Most students will have difficulty distinguishing between the **decimal point** and the **delimiter that separates the thousands**. So train the learner to estimate the order of magnitude of their answer. If they cannot see if there is a decimal point or a delimiter, they will still know which one it is. They need to learn how to estimate if a number is larger than a thousand or a million (so might contain one or two delimiters), and if it is a decimal number (so contains a decimal point).

Students may also have difficulties in reading **scientific notation** (such as  $4.5 \times 10^3$ ). Depending on the type of calculator, the powers of ten may be hard or impossible to read. Tell them how to recognize if the calculator displays scientific notation. They may need a fellow student or a teaching assistant to help them read these numbers.

### 2.10.3

#### Choosing a hand-held calculator

##### Useful for: Low vision

Regular calculators vary in their suitability for use by low-vision students. Check the following before buying a calculator:

- **Calculator used by sighted classmates.** If the sighted learners all use the same make of calculator, try to find one that is as similar as possible to this for the blind or visually impaired learner.
- **Keys.** The numbers must be large and clear for the student to read.
- The **display brightness** should be sufficient.
- The **display font** should be large enough.
- Scientific notation should be in a readable font (compare images A and B below).
- The **decimal separator** and the **thousands delimiter** should be easily distinguishable. It is best to have a space as the delimiter, or no delimiter at all. Compare images A and C below. In image A, a decimal point and no delimiter is used. In image C, it is hard to distinguish between the delimiter (comma) and the decimal point.

A

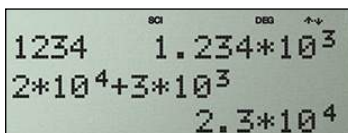

$10^3$  and  $*10^4$  are easy to read

B

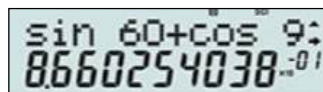

$10^{-01}$  is hard to read

C

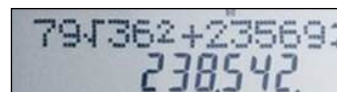

Hard to distinguish between decimal point and thousands delimiter

#### Output displays of various calculators.

English uses commas (or spaces) as delimiters to separate the thousands, and a point to mark decimals: 1,234.56 or 1 234.56.

Most other languages use points (or spaces) as delimiters to separate the thousands and a decimal comma: 1.234,56 or 1 234,56.

Because it can be hard for low-vision learners to distinguish between a comma and a point, it is best to choose a calculator that uses a space as the thousands delimiter.

In computer software such as Excel, you can change the type of decimal sign and thousands delimiter to use.



### 2.10.4

#### Low-vision calculators

##### Useful for: Low vision

Simple calculators designed for people with poor vision are relatively cheap and easily available. They have large keys with clear text, and the keys may be colour-coded. The display is bigger and clearer than with regular calculators. But they are confined to the basic arithmetic functions: addition, subtraction, multiplication and division, plus square roots and percentages.

Check whether there is a low-vision calculator that is similar to the model used by the sighted students. This will make it easier for the students with low vision to follow the lesson.

Scientific calculators with more functions that are designed for low-vision users tend to be significantly more expensive.



A calculator with limited functions designed for elderly people.



Scientific calculator with large keys and display.

### 2.10.5

#### Talking calculators

##### Useful for: Blind, Low vision

Talking calculators look like regular hand-held calculators, but with larger keys and a bigger display. A voice reads out what is entered or displayed. The learner can use headphones to avoid disturbing other people – though this isolates them from their classmates. Also, it can be difficult to remember figures and expressions that are spoken.

Various talking calculators are available commercially. An example is the **Platon talking calculator**.

Cheaper versions tend to have fewer functions than more expensive models. Since they are costly, it may be preferable to instal a free app on a smart phone or laptop.



Platon talking scientific calculator.

### More information

Askjan: List of talking calculators. <https://askjan.org/solutions/Talking-Calculators.cfm>  
Braillebookstore.com. Math and measuring. [www.braillebookstore.com/Math-and-Measuring](http://www.braillebookstore.com/Math-and-Measuring)  
Job Accommodation Network. <https://askjan.org/solutions/Large-Display-Calculators-or-Adding-Machines.cfm>  
LS&S. Low-vision calculators. [lssproducts.com/low-vision-electronics/calculators/](http://lssproducts.com/low-vision-electronics/calculators/)  
LS&S. Talking calculators. [lssproducts.com/platon-talking-scientific-calculator/](http://lssproducts.com/platon-talking-scientific-calculator/)  
MaxiAIDS.com. Low-vision calculators. [www.maxiaids.com/low-vision-calculators](http://www.maxiaids.com/low-vision-calculators)  
MaxiAIDS.com. Talking calculators. [www.maxiaids.com/talking-calculators](http://www.maxiaids.com/talking-calculators)  
Platon talking scientific calculator: [maxiaids.com/platon-talking-scientific-calculator](http://maxiaids.com/platon-talking-scientific-calculator)  
[lssproducts.com/platon-talking-scientific-calculator/](http://lssproducts.com/platon-talking-scientific-calculator/)  
Platon calculator manual: [lssproducts.com/content/241012.pdf](http://lssproducts.com/content/241012.pdf)  
RNIB. <https://shop.rnib.org.uk/education/curriculum-subjects/stem>

### 2.10.6

#### Braille devices

##### Useful for: Blind

Braille devices with built-in scientific calculators include the Mountbatten, PACmate and BrailleNote. See **Braille notetakers** in the section on **Braille** for details.

### More information

BrailleNote. <https://www.humanware.com/microsite/bntouch/index.php>  
Mountbatten. <https://mountbattenbraille.com/mountbatten/>  
PACMate. <https://support.freedomscientific.com/Products/Blindness/PACMateProductFamily>

### 2.10.7

#### Smartphone and tablet apps

##### Useful for: Blind, Low vision, Sighted

New and updated apps appear constantly. Check the app store on your device for newer or alternative versions of the apps described in this section.

Smart phones and tablets come with pre-installed calculator apps. To improve usability, change the accessibility settings to suit the learner's needs.

More suitable calculators can be found in app stores. You can download and install apps on your device from the app store.

The next sections describe some apps that work well.

### More information

#### Changing settings

Android. <https://support.google.com/accessibility/android/answer/6006564>  
Apple. <https://www.apple.com/accessibility/> and <https://www.perkinselearning.org/technology/blog/how-make-ipad-accessible-low-vision-0>

#### App stores

Android. <https://play.google.com/store>  
Apple. <https://www.apple.com/app-store/>

### Big calculator

This is a basic calculator for visually impaired students. The Big calculator is an app that has large numbers and good contrast. It is not a scientific calculator, so it can do only the basic arithmetic operations,  $+$   $-$   $\times$   $/$ . It is available for Apple only.

### More information

<https://large-print-apps.com/big-calculator-low-vision-app.html>

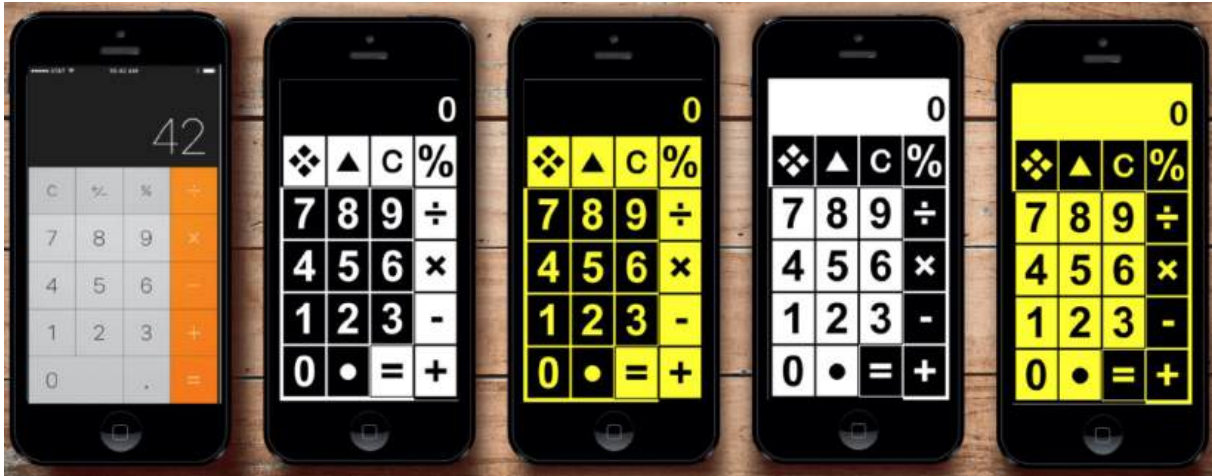

The Big calculator app on a smartphone.

### Geogebra graphing calculator app

Geogebra is a free app that resembles a graphing calculator because it can display graphs. It has an exam setting, to prevent cheating. To make the display easier to read, you can make the font size larger and hide the grids and axes.

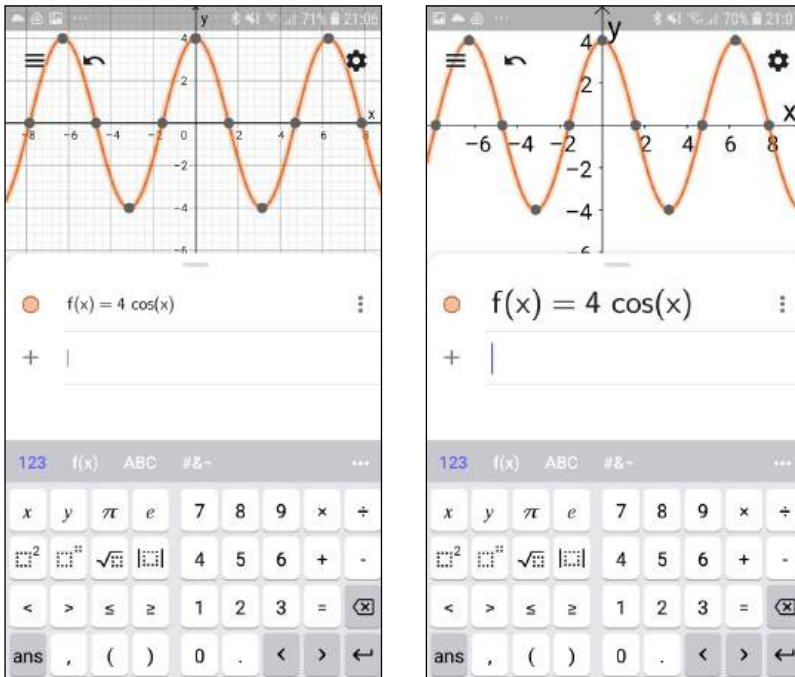

Geogebra app in standard mode (left) and with a larger font and no grid (right).

### More information

Android. <https://play.google.com/store/apps/details?id=org.geogebra.android.scicalc>

Apple. <https://apps.apple.com/us/app/geogebra-scientific-calculator/id1412748754?ls=1>

### MyScript

MyScript uses handwriting input that can recognize handwriting and displays calculation results in large, clear text.



MyScript lets you calculate by writing with your fingertip on a smartphone.

### More information

MyScript calculator. <https://www.myscript.com/calculator/>

Android. <https://play.google.com/store/apps/details?id=com.myscript.calculator>

Apple. <https://apps.apple.com/us/app/myscript-calculator-handwriting-calculator/id1304488725>

### Calculator+

Calculator+ is a scientific calculator, graphing calculator, base converter, and more, with different colour modes available. The scientific calculator function is free, but the other sections of the app cost money. It is for Apple only.

### More information

<https://apps.apple.com/us/app/calculator/id351815470>

### Talking Scientific Calculator

**Useful for: Blind, Low vision**

This app has an optional high-contrast setting and can give audio readouts of the answers, button names and formulas.

#### More information

<https://apps.apple.com/us/app/talking-scientific-calculator/id411433609>

### Sensemath

**Useful for: Blind, Low vision**

The app makes graphs audible for blind students. A blind learner can enter one or more functions and the app makes the graph(s) audible by increasing or decreasing the pitch. It has separate sounds for intersections with axes and/or other graphs.

#### More information

Sensemath. Making math functions audible. <https://www.visio.org/en-gb/professional/expertise/onderzoeken/digitale-ontwikkelingen-innovaties/sensemath>

Apple. <https://apps.apple.com/nl/app/sensemath/id1546257766>

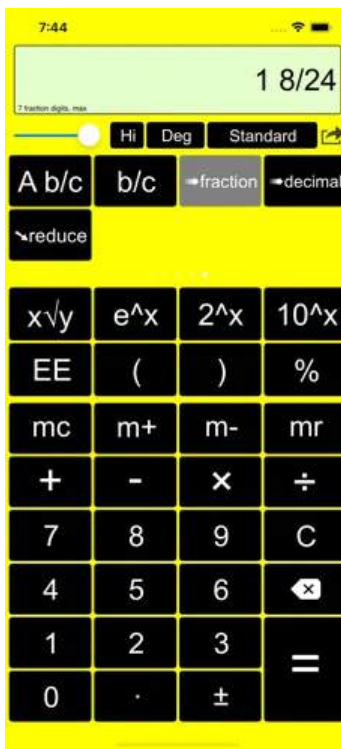

Talking scientific calculator.

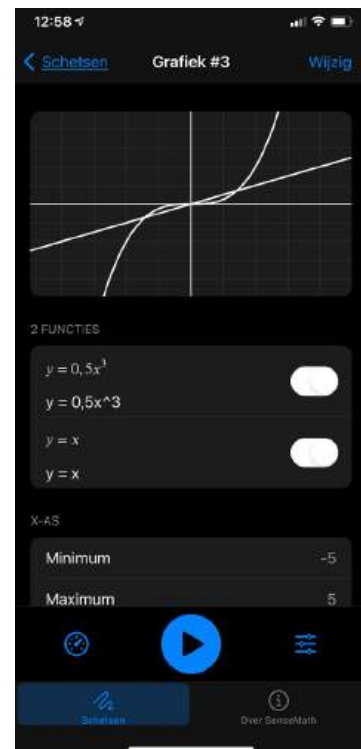

Sensemath.

### 2.10.8

#### Computer calculator apps

**Useful for:** Blind, Low vision, Sighted

A wide range of calculator apps are available for computers for both blind and visually impaired learners. See **Table 4** to choose the best option.

**Table 4. Selecting a computer app as a calculator**

App	Performance	Cost	Suitable for blind learners?
Windows calculator	Comes with Windows Graphing option	Free	Yes, with screen reader software
AllerCalc	Input resembles braille notation of mathematical expressions Can copy and paste both calculations and answers Easy keyboard operation	Free	Yes, with screen reader software
Excel	Valuable office-productivity program Resembles maths braille notation	Requires Microsoft Office	Yes, with screen reader software
Google Sheets	Office-productivity program, similar to Excel	Free	Yes, with screen reader software
Calculator emulators	On-screen version of hand-held device used by classmates	Free trial period	No

### 2.10.9

#### Built-in Windows calculator

**Useful for:** Blind, Low vision, Sighted

The built-in Windows calculator can be used in several modes: standard, scientific, graphing, measurement conversions, etc. This makes it useful at all levels of maths education.

The built-in calculator can be optimized for use by both blind and low vision students.

#### Optimizing display settings for visually impaired students

For visually impaired students you can enlarge the calculator by expanding the window. This also makes the font on the keys a little larger.

Adjusting the Windows accessibility settings can make it bigger still and change the contrast.

See below under **Computers** for how to change these settings.

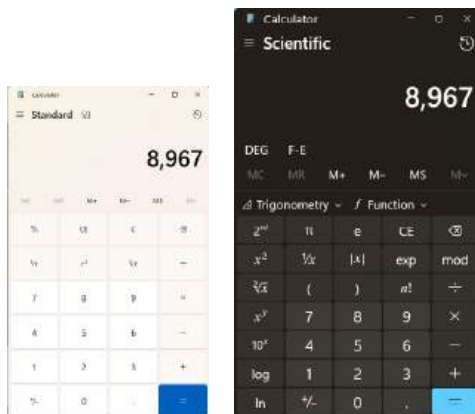

The Windows calculator app in default mode (left), and with larger type and objects and in high contrast mode and scientific mode (right).

**Keyboard input for blind students****Useful for: Blind, Low vision, Sighted**

Blind students will use the keyboard rather than the mouse to enter numbers and calculations on the computer. This is a good idea for other students too. There are shortcuts for functions such as square root, logarithm, trigonometry functions and using the memory. Some keys must be pressed in a different order from regular notation.

	Regular notation	Windows Calculator
Negative numbers (should be between parentheses)	$-2 + \frac{3}{-4}$	<code>(-2) + 3/(-4)</code>
Square root	$\sqrt{2}$	<code>2@</code>
Multiply	$10 \times 3$	<code>10 * 3</code>
Divide	$\frac{81}{3}$	<code>81/3</code>
Fractions	$1\frac{2}{3}$	<code>5/3</code> or <code>1+2/3</code>
Logarithms	$\log(4)$	<code>4l</code>
Sine	$\sin(60)$	<code>60s</code>
Cosine	$\cos(90)$	<code>90o</code>
Tangent	$\tan(45)$	<code>45t</code>

Examples of keyboard shortcuts in Windows Calculator (scientific mode).

**More information**

Complete list of keyboard strokes for the Windows Calculator

[www.shortcutmania.com/Windows-7-Calculator-Keyboard-Shortcuts-printable-cheatsheet.htm](http://www.shortcutmania.com/Windows-7-Calculator-Keyboard-Shortcuts-printable-cheatsheet.htm)  
<https://support.microsoft.com/en-us/windows/keyboard-shortcuts-in-apps-139014e7-177b-d1f3-eb2e-7298b2599a34>

**2.10.10****AllerCalc****Useful for: Blind, Low vision, Sighted**

AllerCalc is a versatile calculator available for free. It can be optimized for use by both blind and sighted students. This section gives detailed instructions as no online guide is available.

**Keyboard input for blind students**

Blind students will use the keyboard rather than the mouse to enter numbers and calculations on the calculator. This is recommendable for other students too. The AllerCalc input is close to the braille notation for mathematical expressions, but there are some exceptions.

## Settings

The settings below will improve the ease of operation for visually impaired students. From the Options menu, change the following options and choose Exit from the Options menu afterwards to save the changes.

**Hide keypad:** hiding the keypad makes it easier to navigate between AllerCalc and other programs. The students can maximize the Allercalc window and use the computer keyboard to enter information.

**Display options** (for students with low vision): change the font and its size and colour:

- **Advisory settings:** Display. Font size 18 (depends on the degree of visual impairment).  
Some students prefer black or grey text on blue.
- **Advisory settings:** Keypad. Number keys & Operator keys: font size 14. Function keys: font size 10.  
Change the colour of the operator keys from yellow to black.

**Angle unit.** Set this to Degrees (or Radians).

**New line after calculation.** Check this option.

**Significant digits.** Set the number of significant digits to (for example) five. Otherwise AllerCalc uses up to 15 significant digits for the answer.

**Exit.** After implementing those changes, close AllerCalc by choosing Exit from the Options menu. Otherwise, your changes will not be saved.

## Shortcuts and hotkeys

The shortcuts, commands and hotkeys below are essential for blind students, but all students will benefit from using them.

	Command	Effect
Remove all previous calculations	clr ctrl + a, delete	Clear Select and delete
Close the program	off exit	Exit
Access the menu	alt + o alt + c alt + f	Options menu Commands menu Functions menu
Copy, paste & select options	ctrl + c ctrl + v shift + arrow shift + home shift + end	Copy Paste Select by character Select until start of line Select until end of line



### Calculations

A full list of options for calculations is available in the Functions menu, which is accessible by the hotkeys alt, f, t. The table below lists only the most commonly used.

	Regular notation	AllerCalc
<b>Negative numbers</b> use parentheses	$-2 + \frac{3}{-4}$	$(-2) + 3/(-4)$
<b>Decimal numbers</b> use a decimal comma	1.23 or 1,23	1,23
<b>Add</b>	$4 + 5$	$4 + 5$
<b>Subtract</b>	$8 - 3$	$8 - 3$
<b>Multiply</b>	$10 \times 3$	$10 * 3$
<b>Divide</b>	$\frac{81}{3}$	81/3
<b>Fractions</b>	$1\frac{2}{3}$	5/3 or 1+2/3 Allercalc does not return fractions as an answer. 1/4 is returned as 0.25
<b>Scientific notation</b>	$5.67 \cdot 10^{-3}$	5,67*10^(-3) or 5,67E-3
<b>Exponents</b>	$4^2$ $3e^x$	$4^2$ $3*exp(x)$
<b>Roots</b>	$\sqrt{102}$ $\sqrt[3]{8}$	sqrt(102) $8^{(1/3)}$
<b>Logarithms</b>	log(10) ln(2) ${}^2\log(16)$	log(10) ln(2) logn(2;16)
<b>Trigonometry</b>	$\pi$ sin(0,75) $\sin^{-1}(37)$	pi sin(0,75) arcsin(37)
<b>Statistics</b>	4! $\binom{n}{k}$	4! bico(n;k)

## Advanced use

	Regular notation	AllerCalc
<b>Zero(s)</b> use t as variable	Find zeroes on the interval [-50, 50]. <b>Result:</b> 2 zero(s) found in the interval [-50, 50] -1,73205 1,73205  Finds zeroes on the interval [0, 10] with precision 0,01	fzeros(t^2-3)  fzeros(t^2-3; 0; 50; 0,01)
<b>Intersection(s)</b> use t as variable	To find the intersection(s) of the functions f(x)=0,1x <sup>2</sup> -1 and g(x)=sin(x)  1. Equate them: 0,1*t <sup>2</sup> -1 = sin(t) 2. Make one side zero: 0,1*t <sup>2</sup> - 1 - sin(t) = 0 3. Use fzeros to find the intersections.  <b>Result:</b> 4 zero(s) found in the interval [-50, 50]: -4,42653 -3,10682 -1,08204 3,1496	fzeros(0,1*t^2 - 1 - sin(t))
<b>Derivative</b> use t as variable	Calculate the value of the derivative of sin(t) for x = pi Result: -1 (if angle unit is set to radians).	fdiff(sin(t); pi)
<b>Integration</b> use t as variable	Calculate the integral of sin(t) over the interval [0, pi]. <b>Result:</b> 2,0 (if angle unit is set to radians).  Calculate the integral of f(t) = 1/t over the interval [1, 3]. <b>Result:</b> 1,09861229.	fint(sin(t); 0; pi)  fint(1/t; 1; 3)
<b>Random numbers and dice</b>	Generate a random number between 0 and 1.  Create a six-faced die by combining the integer function int and rnd.	rnd int(rnd*6)+1
<b>Physical constants</b>	AllerCalc contains a variety of physical constants, accessible via the menu Functions > Constants.  At the bottom of the list is the option User defined constants, which allows the user to add constants.	Hotkeys: alt, f, c.
<b>Summations</b> use t as variable	Calculate the Riemann sum of y = 1/2 <sup>x</sup> with step size = 1 on the interval [1, 100]: $\sum_{k=1}^{100} \frac{1}{2^k} = \frac{1}{2} + \frac{1}{4} + \frac{1}{8} + \dots = 1$  Calculate the Riemann sum of y = 1/2 <sup>x</sup> with step size = 2 on the interval [1, 100]: $\sum_{k=1}^{50} \frac{1}{2^{2(k-1)}} = \frac{1}{2} + \frac{1}{8} + \frac{1}{32} + \dots = \frac{2}{3}$  Calculate the Riemann sum of y = x <sup>2</sup> with stepsize 0,1 on the interval [1, 3]. Result: 82,7.	fsum(1/2^t; 1; 100)  fsum(1/2^t; 1; 100; 2)  fsum(t^2; 1; 3; 0,1)

**More information**

Download AllerCalc. [allercalc.en.softonic.com](http://allercalc.en.softonic.com)

**2.10.11****Excel****Useful for: Blind, Low vision, Sighted**

Excel can be used as a calculator by both blind and sighted students.

**Training materials**

Excel help & learning. <https://support.microsoft.com/en-us/excel>

Use Excel as your calculator. <https://support.microsoft.com/en-us/office/use-excel-as-your-calculator-a1abc057-ed11-443a-a635-68216555ad0a>

**Excel functions useful in maths**

Overview of formulas in Excel. <https://support.microsoft.com/en-us/office/overview-of-formulas-in-excel-ecfdc708-9162-49e8-b993-c311f47ca173>

Excel functions (by category). <https://support.microsoft.com/en-us/office/excel-functions-by-category-5f91f4e9-7b42-46d2-9bd1-63f26a86c0eb>

Excel functions (alphabetical). <https://support.microsoft.com/en-us/office/excel-functions-alphabetical-b3944572-255d-4efb-bb96-c6d90033e188>

Keyboard shortcuts in Excel. <https://support.microsoft.com/en-us/office/keyboard-shortcuts-in-excel-1798d9d5-842a-42b8-9c99-9b7213f0040f>

**2.10.12****Calculator emulators****Useful for: Low vision, Sighted**

An emulator is an app that runs on a computer (or tablet or smartphone) which looks and works like a hand-held calculator. The advantage for visually impaired learners is that the font is larger and the screen is brighter than on the hand-held version.

Many manufacturers sell an emulator for every physical calculator they bring to market.

You can use the emulator to teach the students how to use a calculator on a big screen or projector. If you do so, low-vision learners can sit at the front of the class so they can see the screen more easily. Adjust the computer settings to make the screen more visible for visually impaired students (see **Computers**).



How the emulator appears on a computer screen. The output display is enlarged on the right.

This section contains information on where to download emulators from the calculators:

- Texas instruments
- Casio
- HP

### Texas Instruments

Texas Instruments emulators require a paid license.

For **scientific non-graphing calculators**, visit the TI-SmartView Emulator Software website (see below).

Here are suitable settings for low-vision learners.

- Calculator faceplate: light, dark, or outline only
- Hide key history: ctrl + k
- Screen shot: ctrl + t

For **graphing calculators** visit the TI-SmartView emulator for MathPrint website (see below).

### Casio

Casio emulators can be tested for free for 90 days. After this, you have to pay.

### Hewlett-Packard

Some Hewlett-Packard emulators are available for free.

### Download emulators and manuals

Texas Instruments.

- TI-SmartView emulator for MathPrint calculators <https://education.ti.com/en/products/computer-software/ti-smartview-30x-mp?category=resources>
  - TI-SmartView CE emulator software for the TI-84 Plus <https://education.ti.com/en/software/update/84-ce-software-update/84ce-download?q1=SmartviewCESW&count=1>
- Casio. <https://edu.casio.com/softwarelicense/index.php>
- Hewlett-Packard. <https://www.hp-prime.de/en/category/15-software>

## 2.11

### Computers

Useful for: Blind, Low vision, Sighted

Computers are very useful tools for teaching and learning, as well as being vital equipment for many jobs and aspects of daily life.

They are particularly useful for teaching mathematics as they can display many of the ideas in maths: numbers, shapes, relationships, etc. The main programs for teaching mathematics are calculator apps (such as Windows Calculator) and spreadsheets (such as Microsoft Excel). See the section on **Computer calculator apps** for details.

Computers (and tablets and smartphones) are the gateway to the internet. You can find many lessons online that you can adapt and use as classroom or homework assignments. Students can also use the Internet to learn on their own.

If the school has a **computer lab**, one or more computers can be set up for blind or low-vision learners.

The **resource room** may have equipment that learners can borrow or use in the room. This equipment can be set up permanently for blind or low-vision learners.

If the learners have their **own laptops or tablets** that they bring with them to class, these can be set up to suit the needs of each learner.

New and updated computer apps appear constantly. Check the internet for newer or alternative versions of the apps described in this section.

#### 2.11.1

##### Learning with a computer

Useful for: Blind, Low vision, Sighted

Using a computer (or tablet or smartphone) is a set of skills that must be learned. In general smartphones and tablets are easier to learn for sighted users than a computer. But they rely on tapping, pointing and swiping with the fingers on a smooth surface, so may be difficult for low-vision and blind learners to master.

Blind and low-vision learners can learn how to type on a keyboard and use a computer. Various software and hardware tools can help them do this. See **More information** for some ideas.

Learners can use a computer (or tablet or smartphone) to learn independently and at their own pace. You can set exercises that learners can do in their own time. Since blind or low-vision learners tend to work more slowly than sighted users, you can select a subset of exercises for them to do. Put them in a separate folder so the learners can find them easily.

##### More information

Willings, C. 2019. Keyboarding instruction. Teaching students with visual impairments.  
[www.teachingvisuallyimpaired.com/keyboarding-instruction.html](http://www.teachingvisuallyimpaired.com/keyboarding-instruction.html)

### 2.11.2

#### Using a computer with a big screen or projector

Useful for: Blind, Low vision, Sighted

You can use a computer in combination with a big screen, digital whiteboard or a projector to teach maths in the classroom.



A digital whiteboard with a calculator emulator.

Blind learners may be able to use their own computer or tablet with headphones to follow what you are showing on the screen. However, using headphones can isolate them from what is happening in the classroom.

Low-vision learners can sit at the front of the class so they can see the screen more easily. Adjust the computer display settings to increase the size of the type and the pointer, and to use high contrast.

Make sure you say out loud what you are typing, and what is shown on the screen. Use a stick to point at the screen rather than relying only on the mouse pointer.

### 2.11.3

#### Display settings

Useful for: Low vision

You can adjust the settings in your computer to make the screen easier to read. The features depend on your operating system and may change over time.

**Windows.** Go to Settings > Ease of Access (Windows 10) or Accessibility (Windows 11). Here you can: Change the **display settings**: Make the text and objects bigger and brighter.

Change the **mouse pointer**: Make the mouse pointer bigger so it is easier to see.

Change the **text cursor**: Make the text cursor bigger.

Use a **magnifier**: Makes everything on the screen bigger. Shortcuts: Press the Windows logo key + Plus (+) to turn the Magnifier on. Press the Windows logo key + Esc to turn the Magnifier off.

Change the **colour settings**

Use **high contrast** (dark background and light type). You can also press Alt + left Shift + Print Screen to turn high contrast on and off

**Apple.** See the Apple accessibility guide.

**Add-on apps.** You can install add-on software to enlarge portions of the screen. Apps also come bundled with screen-reading software that reads out what is displayed on the screen (see the section on **Screen readers**).

#### More information

Apple accessibility guide. <https://www.apple.com/accessibility/>  
American Foundation for the Blind. Screen magnification systems.  
<https://www.afb.org/node/16207/screen-magnification-systems>

#### 2.11.4

##### Voice narration

###### Useful for: Blind, Low vision

You can set up a computer so a voice (the Narrator) reads what is on the screen. You can change the voice and language the Narrator uses. Learners should use headphones or earplugs so the voice does not disturb other learners.

**Windows.** Go to Settings > Ease of Access (Windows 10) or Accessibility (Windows 11) > Narrator.

**Apple.** See the Apple accessibility guide.

**Adobe Acrobat.** Adobe Acrobat, the standard software for displaying the PDF file format, can read documents out loud. Press Ctrl + Shift + Y to activate Read Out Loud mode.

#### More information

Guide to the Narrator in Windows 10. <https://support.microsoft.com/en-us/windows/complete-guide-to-narrator-e4397a0d-ef4f-b386-d8ae-c172f109bdb1>  
Apple accessibility guide. <https://www.apple.com/accessibility/>

#### 2.11.5

##### Screen readers

A screen reader is a software application that takes a text file (such as a word-processing document) and reads it out using a voice synthesizer or puts the text on a braille display. Common screen readers include JAWS, NVDA, Simply Talker, Zoom Text and TextAloud.

#### 2.11.6

##### JAWS

JAWS stands for Job Access With Speech. It is a screen reader available in 17 languages and with voices to support 30 languages. It can also work with screen-magnification software such as Zoom Text. Someone with low vision but who has difficulties in braille can use it. It can produce both voice output and braille display. You can use it to navigate the internet, write a document, read an email or create presentations.

#### More information

<https://www.freedomscientific.com/products/software/jaws/>

### 2.11.7

#### **NVDA**

NVDA stands for NonVisual Desktop Access. It is a free screen reader to allow blind or visually impaired people to access information on a computer. It converts the information on the screen information for a refreshable braille display, or reads it out using a voice synthesizer.

#### **More information**

<https://www.nvaccess.org/download/>

<https://addons.nvda-project.org/addons/pcKbBrl.en.html>

### 2.11.8

#### **Zoom Text**

The ZoomText Magnifier/Reader is a magnification and reading program for low-vision users. It enlarges what is displayed on your computer screen, echoes your typing and essential program activity, and automatically reads documents, web pages, email. It works together with the JAWS screen reader, making it possible for low-vision users to listen to the audio at the same time as viewing the enlarged text.

#### **More information**

<https://www.zoomtext.com/products/>

### 2.11.9

#### **TextAloud**

TextAloud converts text from documents, emails and webpages into natural-sounding speech. It integrates with Microsoft Word, as well as browsers such as Google Chrome, Firefox and Microsoft Edge.

#### **More information**

<https://nextup.com/>



## 2.12

### Braille

Useful for: Blind

Braille is a system of writing that uses patterns of raised dots. By running your fingertips over the dots, you can, with training and practice, feel these patterns and read what is written.

We cannot cover all of the rules of braille in this manual. See the **Appendix** to this section and **More information** for more detailed guides.

#### 2.12.1

##### The braille alphabet

Each letter or punctuation mark in braille consists of up to six dots in a particular pattern. There are 63 possible combinations of dots. Each pattern stands for a particular letter or symbol such as a punctuation mark.

 a	 b	 c	 d	 e	 f	 g	 h	 i	 j
-------	-------	-------	-------	-------	-------	-------	-------	-------	-------

 k	 l	 m	 n	 o	 p	 q	 r	 s	 t
-------	-------	-------	-------	-------	-------	-------	-------	-------	-------

 u	 v	 w	 x	 y	 z
-------	-------	-------	-------	-------	-------

The alphabet in braille.

#### 2.12.2

##### Capital letters

A capital letter is shown by adding the sign in front of the letter to be capitalized.

 a	 A
-------	-------











If you need to capitalize a whole word, use two capital signs .











 abc	 ABC
---------	---------

2.12.3





Numbers

Numbers are formed by a combination of the special number sign  plus the first ten letters, a to j.





									
a	b	c	d	e	f	g	h	i	j

										
#	#a	#b	#c	#d	#e	#f	#g	#h	#i	#j
	1	2	3	4	5	6	7	8	9	0

Numbers higher than 9 are formed by a single number sign followed by two or more braille signs.

				
#aj	#aa	#bj	#bde	#bjbc
10	11	20	245	2023

Each new number must be preceded by the  sign.









				
#b	boys	&	#c	girls
2	boys	and	3	girls

2.12.4

Punctuation signs

The punctuation signs use the bottom four dots in the 6-dot cell.

The  sign may be a question mark ? or an opening quote ", depending on where in the sentence it appears.

,	;	:	.	!	? or "	*	"	'
comma	semicolon	colon	full stop	exclamation mark	question mark or open quote	asterisk	close quote	apostrophe
								

### 2.12.5

#### Braille dot positions

The dots in a braille cell are numbered like this:

1 • • 4  
2 • • 5  
3 • • 6

Dots 1,2	Dots 2,3,4	Dots 2,3,4,5	Dots 1,3,4,6	Dots 1,3,4,5,6
b	s	t	x	y
⠠	⠠	⠠	⠠	⠠

Knowing these dot positions is important so both the teacher and the student can identify the character correctly. For example, imagine that the equation  $z + y = 6$  is written in braille. The student reads aloud “ $z + x = 6$ ”. What happened? Did the student miss a dot (dot 5) while moving their fingers over the braille characters? (a “tactile” error). Or do they think that dot 13456 represents the letter x and not the letter y? Knowing the dot positions helps answer such questions.

### 2.12.6

#### Grade 2 braille

**Grade 1** braille spells out each letter, one by one. This takes up a lot of space: a book in braille is much bulkier than the printed equivalent. **Grade 2** (advanced) braille uses a large number of contractions and abbreviations to reduce the amount of space required.

The letters listed above use 26 of the 63 possible dot combinations. Grade 2 braille uses some the remaining dot combinations to stand for common words or common letter combinations in English. For example:

& and	for	of	the	with
⠠	⠠	⠠	⠠	⠠
ch	gh	sh	th	wh
⠠	⠠	⠠	⠠	⠠
ed	er	ou	ow	
⠠	⠠	⠠	⠠	

Grade 2 braille also includes many contractions that consist of two or more braille characters. In addition, certain characters can mean different things if they stand alone or appear together with other characters. For example:

The letter b  $\begin{smallmatrix} \bullet \\ \bullet \\ \bullet \end{smallmatrix}$  standing by itself means "but"

The letter c  $\begin{smallmatrix} \bullet \\ \bullet \\ \bullet \end{smallmatrix}$  by itself means "can"

The letter combination ab  $\begin{smallmatrix} \bullet & \bullet \\ \bullet & \bullet \\ \bullet & \bullet \end{smallmatrix}$  "about"

The letter combination ac  $\begin{smallmatrix} \bullet & \bullet \\ \bullet & \bullet \\ \bullet & \bullet \end{smallmatrix}$  means "according"

### 2.12.7

#### Grade 1 indicators

To avoid confusion, we use a Grade 1 indicator  $\begin{smallmatrix} \bullet \\ \bullet \\ \bullet \end{smallmatrix}$  to show that the following sign should be interpreted as a letter, not as one of these contractions. Two (or three) Grade 1 indicators show the next word (or passage) should be read in Grade 1 mode.

$\begin{smallmatrix} \bullet \\ \bullet \\ \bullet \end{smallmatrix}$	Grade 1 symbol indicator
$\begin{smallmatrix} \bullet & \bullet \\ \bullet & \bullet \\ \bullet & \bullet \end{smallmatrix}$	Grade 1 word indicator
$\begin{smallmatrix} \bullet & \bullet & \bullet \\ \bullet & \bullet & \bullet \\ \bullet & \bullet & \bullet \end{smallmatrix}$	Grade 1 passage indicator
$\begin{smallmatrix} \bullet & \bullet \\ \bullet & \bullet \\ \bullet & \bullet \end{smallmatrix}$	Grade 1 passage terminator

See **More information** for sources of information about braille.

### 2.12.8

#### Mathematics in braille

The braille characters for the letters a–z are the same in most languages and all over the world. But specialist signs such as those used in mathematics vary from language to language. In English, three systems exist:

- The **British** system, which is common in English-speaking Africa
- **Nemeth** – a system used for mathematics in the United States
- **Unified English Braille** – a system that is designed to replace the British and Nemeth systems for English-speaking countries.

This book uses Unified English Braille. Most English-speaking countries have agreed to switch to Unified English Braille, but you may still find teaching and learning materials that use one of the other systems.



In addition, different countries have their own systems for representing mathematics in braille. Make sure you are familiar with the system used in your country.

## 2.12.9

## 6 dots, 63 possible patterns

Braille is restricted to just the 63 different patterns it is possible to make with 6 dots. Mathematics for sighted people uses far more than this – think of the 26 lowercase letters, 26 uppercase letters, the numbers 0–9, and so on. That means that the 63 braille patterns have to do extra work. Some braille characters can be used to mean more than one thing (as in the Grade 2 contractions above), and combinations of two or more characters may have a special meaning.

Mathematical notation in print can use multi-level fractions, superscripts, subscripts and Greek letters to convey information. The spatial relationship and size of the characters carries meaning. The difference between  $32$  and  $3^2$  is obvious to a sighted person. In braille, an extra character is needed to tell the reader that the next character is a superscript:

$32$ #cb 	$3^2$ #c[ <b>superscript</b> ]b 
--	---

Mathematics often puts symbols on top of each other, as in fractions  $\frac{x}{y}$ , statistical notation  $\bar{x}$  and  $\sum_i^n x$ , and matrix algebra  $\begin{pmatrix} 1 & 0 \\ 0 & 1 \end{pmatrix}$ .

But braille is read one line at a time. A complex fraction has to be rendered in braille like this:

$\frac{2+3}{4-1}$
[open general fraction] 2 + 3 [general fraction line] 4 - 1 [close general fraction]

All of the characters (including the numbers) except the final [close general fraction] in this case, translate into two braille characters. More complex expressions are longer still.

To convert mathematical expressions from print to braille, it is necessary first to put the expression in a linear sequence, add in the special characters that denote things like [open general fraction] and [superscript], then convert that sequence into braille characters.

Braille uses a range of characters that have no equivalent in print, such as the signs used to open and close general fractions in the example above. Other characters without a print equivalent include the number sign  $\cdot\cdot\cdot$  and the Grade 1 mode indicator  $\cdot\cdot$  (used to switch from Grade 2 or number mode back to Grade 1).

The rules for Grade 1 braille are fairly simple and easy to learn. The rules for Grade 2 and for mathematical braille are more complicated. Learning these rules takes considerable time and effort on the part of both the learner and the teacher. It is not possible to include all the rules in this



2.12.12

**Long arithmetic**

Just as in normal print, it is necessary to align the columns in long arithmetic in braille. This is difficult in braille. It is helpful to start at the far right, in the units column (or with the decimal point), then match the numbers vertically. A row of ⠠ signs can be used as a separator line. Laying this out requires some mental planning beforehand to work out how many columns will be needed.

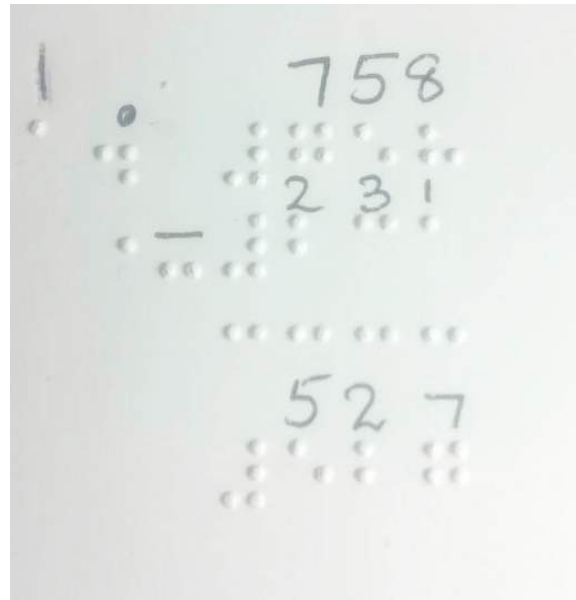
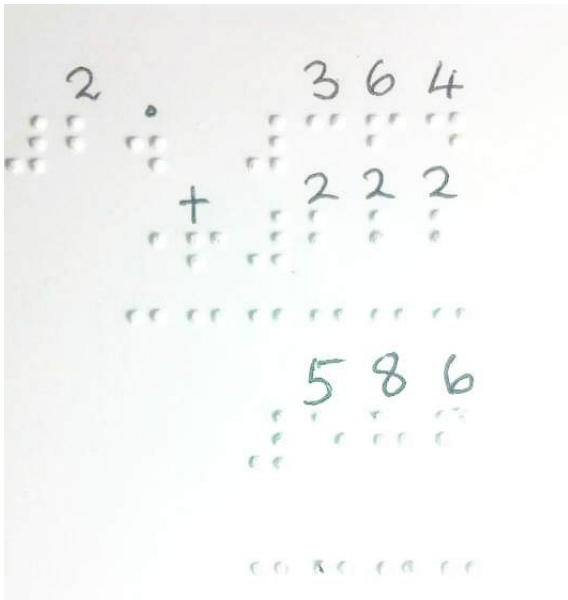

Examples of long addition and subtraction in braille. Note that the units are aligned.

**Using aligned columns**

$\begin{array}{r} 749 \\ \times 21 \\ \hline 749 \\ + 14980 \\ \hline 15729 \end{array}$	$\begin{array}{r} 749 \\ \times 21 \\ \hline 749 \\ + 14980 \\ \hline 15729 \end{array}$
--	--

Below is an alternative layout with the operator sign  $\times$  to the right of the sum rather than to the left. This is easier to lay out in braille.

749

21  $\times$

---

749

14980  $+$

---

15729

### Using a Perkins braille

Start on the right side, type the units first, then move the embossing head back two spaces to type the tens value. Move the head back two spaces to type the hundreds value, and so on until you have typed the complete number.

Then roll the paper forward one row and type the second number in the problem in the same way, making sure the units are lined up above one another.

Type the operator sign (+, - or  $\times$ ) on the left (or the right) side of this number.

Roll the paper forward to make a new row, then type a row of  $\dots$  signs to make a horizontal line.

Then perform the calculation, again starting with the units on the right side. Position the embossing head in a new row in the units column. Feel the two numbers to be calculated, then type the result.

Move the embossing head to the left, feel the next two numbers to be calculated, and type the result.

Type the answer with spaces between the figures so you can feel the individual braille signs easily.

If necessary (for example, in multiplication by a 2-digit number), roll the paper forward another row and repeat the process with the next numbers to be calculated.

Roll the paper forward to make a new row, then type a row of  $\dots$  signs to make a horizontal line.

Roll the paper forward again, and add together the columns of numbers below the horizontal line, starting on the right side.



$451 \times 46 = 20746$

$\begin{array}{r} 451 \\ \times 46 \\ \hline 2706 \\ 18040 \\ \hline 20746 \end{array}$	<p>451</p> <p><math>\times 46</math></p> <hr style="width: 100%;"/> <p>2706</p> <p>18040</p> <hr style="width: 100%;"/> <p>20746</p>
---	--

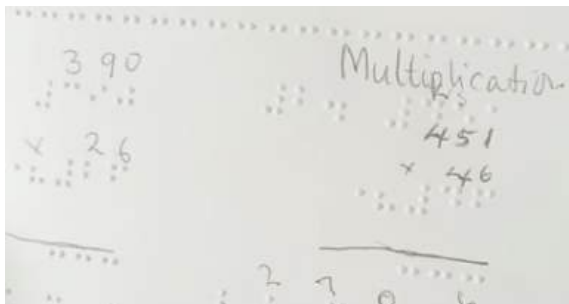

Partially completed long multiplication on a Perkins braille. The learner has included extra spaces in the answer to make it easier to feel each number.

### Using the single line technique

Rather than trying to align the columns, an easier alternative is to break the equation into parts, one on each line.

$451 \times 46 =$	
$451 \times 6 = 2706$	
$451 \times 40 = 18040$	
$2706 + 18040 = 20746$	

2.12.13

Algebra

Because braille uses the same signs for the letters a-j and the numbers 1-9 and 0, it is necessary to use the Grade 1 indicator  $\cdot\cdot\cdot$  to tell the reader that a letter a-j (not a number or a contraction) is intended. To mark the following sign (or signs) as a number, use the # sign  $\cdot\cdot\cdot$

a + b = 3

1 + 2 = 3

In Grade 2 braille, all of the letters (except a, i and o) also have a separate meaning if they stand alone. So a Grade 1 indicator  $\cdot\cdot\cdot$  is needed to avoid confusion. In the first example above, b  $\cdot\cdot\cdot$  without the Grade 1 indicator would mean "but". In the example below, d  $\cdot\cdot\cdot$  without the Grade 1 indicator would be read as "4", and e  $\cdot\cdot\cdot$  standing by itself means "every".

3d + e

#c[grade1]d + [grade 1]e

34 + every

#cd + e

2.12.14

Brackets

Printed mathematics uses three different pairs of brackets: (), [] and {}. The braille equivalents are below.



(      )	[      ]	{      }
$\cdot\cdot\cdot$ $\cdot\cdot\cdot$	$\cdot\cdot\cdot$ $\cdot\cdot\cdot$	$\cdot\cdot\cdot$ $\cdot\cdot\cdot$

2.12.15

Fractions

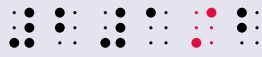

$\cdot\cdot\cdot$	Simple fraction line
$\cdot\cdot\cdot$ $\cdot\cdot\cdot$	General fraction line
$\cdot\cdot\cdot$ or $\cdot\cdot\cdot$ $\cdot\cdot\cdot$	Opening general fraction indicator (used if a fraction contains not just numbers) The Grade 1 indicator $\cdot\cdot\cdot$ is needed if the text is in Grade 2. This is to avoid confusion: $\cdot\cdot\cdot$ means "of" in Grade 2 braille.
$\cdot\cdot\cdot$ or $\cdot\cdot\cdot$ $\cdot\cdot\cdot$	Closing general fraction indicator. $\cdot\cdot\cdot$ means "with" in Grade 2 braille.

For fractions that just contain numbers, the simple fraction line is sufficient. For more complex fractions, the general fraction indicators and line are used. Note that braille takes up a lot of space!

Simple fractions	
$1/2$ #a[fraction line]b 	$2\frac{1}{2}$ #b#a[fraction line]b 
General fractions	
$b/2$ [grade 1][open general fraction]b[general fraction line]#b[close general fraction] 	$\frac{x+y}{x-y}$ [grade 1][open general fraction]x+y[general fraction line]x-y [close general fraction] 

### 2.12.16 Exponentials

Exponentials are written using the superscript sign  $\overset{\cdot\cdot}{\cdot}$ . After a letter, add the Grade 1 indicator  $\overset{\cdot\cdot}{\cdot}\overset{\cdot\cdot}{\cdot}$  to avoid confusion with the Grade 2 contraction  $\overset{\cdot\cdot}{\cdot}$  which means "in".

$2^2 = 4$ #c[superscript]b = #i 	$b^2$ [grade 1]b[superscript]#b 	$x^n$ x[superscript]n 
---	---	---



### 2.12.17 Roots

Printed text has two ways of writing roots: a single character  $\sqrt{\quad}$  and the symbol  $\sqrt{\quad}$  that has a "vinculum" a horizontal line that extends over the whole expression.

Braille has equivalents for these. The simple root  $\sqrt{\quad}$  is  $\overset{\cdot\cdot}{\cdot}\overset{\cdot\cdot}{\cdot}$ . For the  $\sqrt{\quad}$  symbol, it is necessary to show the reader where the vinculum begins and ends. This is done with the open root  $\overset{\cdot\cdot}{\cdot}\overset{\cdot\cdot}{\cdot}\overset{\cdot\cdot}{\cdot}$  and close root  $\overset{\cdot\cdot}{\cdot}\overset{\cdot\cdot}{\cdot}\overset{\cdot\cdot}{\cdot}$  signs. The close root sign has no equivalent in printed text.

$\sqrt{\quad}$	$\overset{\cdot\cdot}{\cdot}\overset{\cdot\cdot}{\cdot}$	Square root
$\sqrt{\quad}$	$\overset{\cdot\cdot}{\cdot}\overset{\cdot\cdot}{\cdot}\overset{\cdot\cdot}{\cdot}$	Open root sign with vinculum
	$\overset{\cdot\cdot}{\cdot}\overset{\cdot\cdot}{\cdot}\overset{\cdot\cdot}{\cdot}$	Close root

For cube roots, add a superscript sign immediately after the opening radical symbol.

$\sqrt{16}$	$\sqrt{a+b}$	$\sqrt[3]{27}$
[root]#af	[open root]a+b[close root]	[open root][superscript]#c#bg[close root]
		

### 2.12.19

#### Learning braille

Sighted children generally first learn the number symbols first, before they learn the letters. With blind children this is the other way around, since they have to learn the letters a-j plus the number sign first.

Blind learners are normally taught braille in separate lessons with a specialist teacher. For mathematics (and for other technical subjects), they will need to learn additional braille signs, such as the arithmetic operators + - × ÷. This is similar to sighted learners, who also have to learn the meanings of these and other symbols. For maths, the maths support teacher can teach the appropriate braille signs (and the structure of expressions in braille) as they are needed in the maths lessons.

A sighted person can learn to use braille in as little as a month. But complete mastery may take years with constant use.

### 2.12.20

#### Writing braille

Braille can be written using various devices. These include the following.

##### Slate and stylus

The slate and stylus were the original way of writing braille, and they are still the cheapest way to do so. A variety of makes and types are available, ranging from pocket-sized, to a few lines of A4 width, to a full A4 sheet. For maths problems, an A4-sized slate is best.

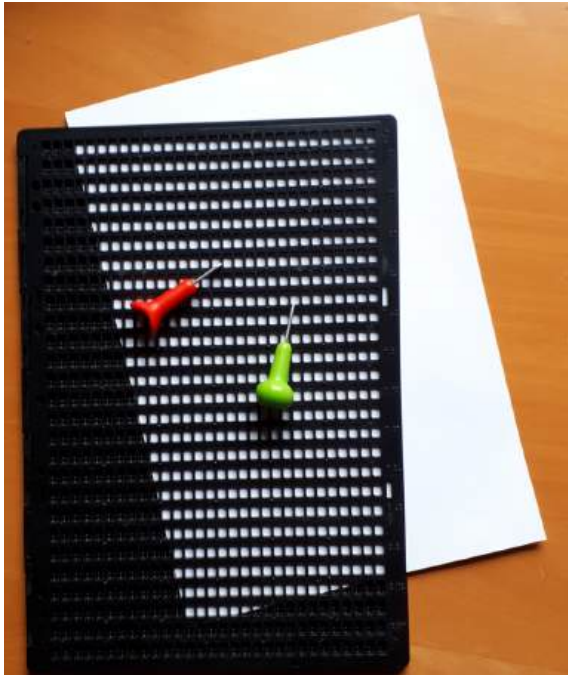

An A4 slate and two types of stylus.

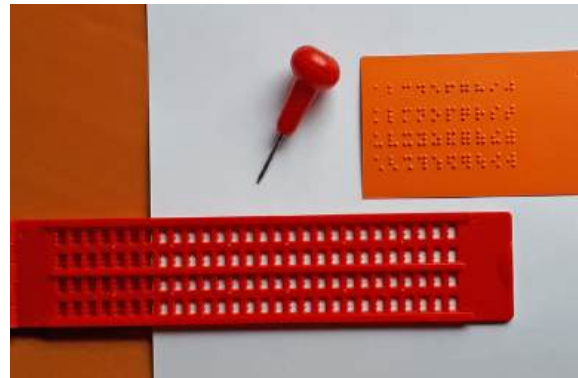

A four-line slate with a stylus and an example of the braille output.

The slate consists of two metal or plastic plates that are hinged on one side. The stylus (or "style") has a metal point, like a nail. A sheet of thick paper is fixed between the two plates of the slate. The top plate has several rows of holes, and bottom plate has small dents under the holes. By pushing the stylus through the holes in the slate, the writer produces bumps on the bottom side of the paper. This writing is done in mirrored form, from right to left, so that afterwards, when the paper is turned over, the bumps can be read from left to right.

### Mechanical brailier

A mechanical brailier looks like a typewriter with nine keys – one for each dot in the braille cell, plus a space bar in the middle, a line-spacing key and a backspacer. The most commonly used form is known as the Perkins brailier. Special paper is fed into the top, and the user presses combinations of the keys to create the braille signs.



Perkins brailier. Combinations of six of the keys create the braille patterns.

### Electronic braille

Electronic braille printers use a similar system to their mechanical counterparts, but are quieter and easier to operate. Some can store the input on a USB stick.

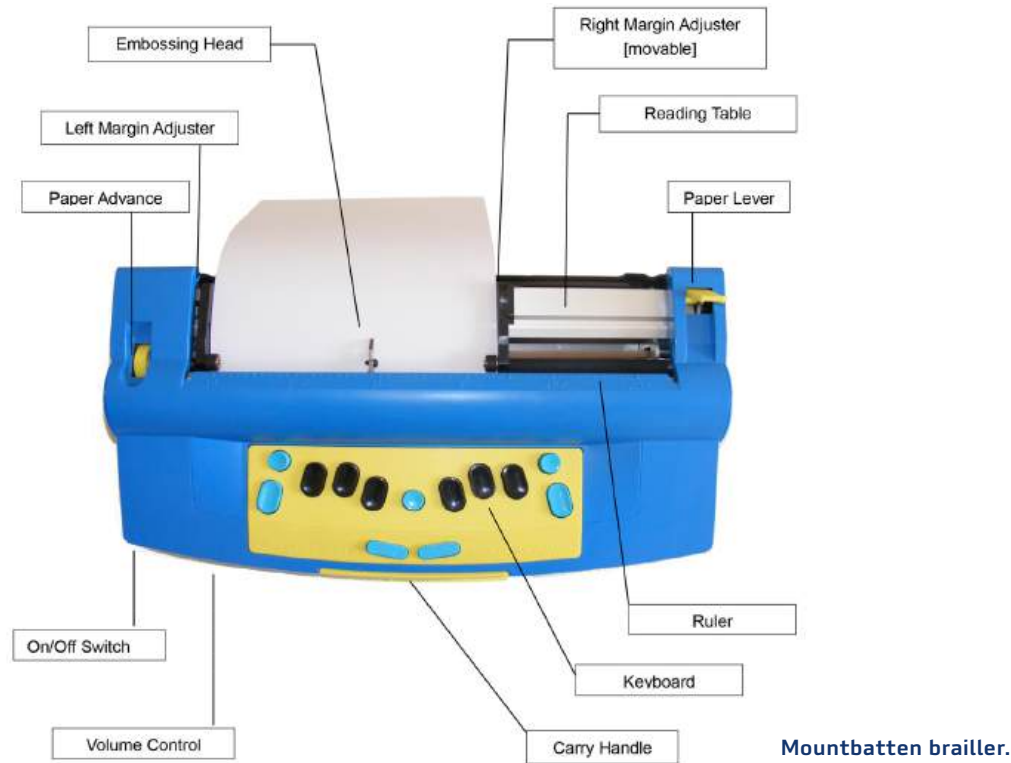

### Braille notetakers

Electronic braille notetakers are portable devices that have a Perkins- or computer-style keyboard and a tactile braille display. This display consists of a series of round-headed pins that are pushed up through a grid.

Some have a visual display for teachers, and a voice synthesizer that reads out what is written. The more sophisticated notetakers come with software that makes them similar to a tablet computer, and can download and install apps from the Google Play Store.

Notetakers are useful for taking notes in class and can be used as braille displays that interact with a computer, smartphone or tablet. The notes can be stored for display or editing later.

Most notetakers have only one line, so they cannot be used for multi-line calculations such as multiplication and long division.



**A braille notetaker. The keys at the top are used to input text. The user's hands are on the refreshable braille display.**

### Refreshable braille display

A refreshable braille display has a row of round-tipped pins that are raised through holes in a flat surface to form braille characters. Many use an 8-dot version of braille that is an extension of the normal 6-dot braille.



Refreshable braille display used with a computer keyboard. This display uses the 8-dot braille system.



The BrailleNote Touch device combines a braille display with a visual screen. It has both a virtual keyboard (type braille on the touchscreen) as well as a standard braille keyboard (like an electronic brailier) that flips down over the screen.

### Braille translation software

A braille translator is a software application that converts a computer file in regular text to braille (and vice versa). Some braille translators are available online for free. They can convert text you type into braille for output as an ASCII file or an image. Some can translate into different braille standards, such as Unified English Braille, British braille, or braille codings used in other languages.

Free translators have shortcomings. For example, they may not convert punctuation or capitals, or they may produce errors because they fail to interpret many of the rules correctly. So it is best to have a human specialist check the transcription before using it.

More sophisticated braille translators cost money. Most providers offer free demonstration versions so you can try the program out before buying it.

The leading translator is produced by Duxbury Systems This is a computer program that functions like a word processor. You can type plaintext or import a word-processing document and then have the software translate it into braille. The software also handles illustrations. It prepares a document file that can be sent to an embosser.

Translation software does not necessarily convert mathematics correctly. Always have a specialist check the braille before using it.

### Computer and embosser

Computers (see the section on **Computers**) can be combined with a braille embosser to produce braille output.

An embosser is a printer that produces raised dots on the paper. The embosser is controlled by a computer or other device that tells it what to print. Some embossers can print ink on the same sheet to make the content easier to use for sighted users.

Embossers tend to be more expensive than a regular printer, costing \$5,000 or more. They come with dedicated software such as fonts and a program to translate your file into correct braille. They can also convert drawings into a series of embossed dots. They can work with standalone translators such as the Duxbury Braille Translator.



A braille embosser.

### Braille transcription and embossing services

In some countries, you do not have to worry about preparing braille or tactile materials yourself. You can email a document with text and diagrams to a specialist transcription service. This converts the document to braille (and converts the pictures to tactile form), embosses it, and ships it back to you within a couple of days.





































































2.12.21

Appendices

Appendix 2.1

Grade 1 braille

Braille consists of 63 possible signs (64 if you count the empty space with no dots). Grade 1 braille uses only some of the 63 possible braille signs: 26 letters, plus some punctuation and special signs.

Upper signs	 a 1	 b 2	 c 3	 d 4	 e 5	 f 6	 g 7	 h 8	 i 9	 j 0
 + dot 3	 k	 l	 m	 n	 o	 p	 q	 r	 s	 t
 + dots 3 and 6	 u	 v	 x	 y	 z					
 + dot 6										 w
Lower signs	 ,	 ;	 :	 .		 !		 ? "	 *	 "
										 [space]
	 number	 letter	 capital							

Grade 1 braille signs. Signs in the shaded cells are not used in Grade 1 braille.

The signs in the top row form the letters **a–j**. Adding a dot 3 to these signs forms the next 10 letters, **k–t** (second row). Adding dots 3 and 6 creates the remaining letters (third row). The letter **w** is the odd one out since it was not part of the French alphabet when Louis Braille invented his system.

The letters **a – j** are read as numbers **1 – 0** if they are preceded by the number sign.

 = 1

The capital letter sign  turns the following letter into a capital.

 = A















The letter sign  turns the following sign into a letter.















 = 1a















Appendix 2.2













Grade 2 Unified English Braille contractions











Here is a full list of the contractions used in Grade 2 Unified English Braille.











										
alone	a	but	can	do	every	from	go	have	l	just
Preceded by										
					-ence		-ong			
				-ound	-ance					
				day	ever	father	God	here		
			cannot					had		





										
alone	know- ledge	like	more	not	o	people	quite	rather	so	that
Preceded by										
		-ful		-tion					-ness	-ment
										
				-sion					-less	-ount
	know	lord	mother	name	one	part	question	right	some	time
			many						spirit	

	 u	 v	 x	 y	 z	 & and	 for	 of	 the	 with
alone	us	very	it	you	as					
Preceded by										
				-ity						
	under			young					there	
	upon								these	
									their	

	 ch	 gh	 sh	 th	 wh	 ed	 er	 ou	 ow	 w
alone	child		shall	this	which			out		will
Preceded by										
	charac- ter			through	where			ought		work
				those	whose					word
										world



















	 ,	 ;	 :	 '	 -	 !	 -	 ?	 *	 "
alone	-ea-	-bb-	con -cc-	dis	en	-ff-	-gg-	? "	*	"
		be			enough	to	were	his	in	was, by

	 '	 -	 -ing	 [accent]	 /	 ar	 [whole]	 [whole]	 [whole]	 [space]
alone					st		.	^	-	
					still					

 [number]	 [partial] [letters]	 [partial] [capital]	 [partial]
---	---	---	--

### Appendix 2.3 Grade 2 Unified English Braille abbreviations

Abbreviation	Word	Braille
A		
ab	about	⠠⠠⠠⠠⠠⠠
abv	above	⠠⠠⠠⠠⠠⠠⠠
ac	according	⠠⠠⠠⠠⠠
acr	across	⠠⠠⠠⠠⠠⠠
af	after	⠠⠠⠠⠠
afn	afternoon	⠠⠠⠠⠠⠠⠠⠠
afw	afterwards	⠠⠠⠠⠠⠠⠠⠠
ag	again	⠠⠠⠠⠠
alm	almost	⠠⠠⠠⠠⠠⠠
alr	already	⠠⠠⠠⠠⠠⠠
al	also	⠠⠠⠠⠠
alTH	although	⠠⠠⠠⠠⠠⠠⠠
alt	altogether	⠠⠠⠠⠠⠠⠠⠠
alw	always	⠠⠠⠠⠠⠠⠠

Abbreviation	Word	Braille
<b>B</b>		
BEc	because	
BEf	before	
BEh	behind	
BEl	below	
BE n	beneath	
BEs	beside	
BEt	between	
BEy	beyond	
bl	blind	
brl	braille	
<b>C</b>		
CHn	children	
CONcv	conceive	
CONcvg	conceiving	
cd	could	
<b>D</b>		
dcv	deceive	
dcvg	deceiving	
dcl	declare	
dclg	declaring	
<b>E</b>		
ei	either	

Abbreviation	Word	Braille
F		
fST	first	
fr	friend	
G		
gd	good	
grt	great	
H		
hERf	herself	
hm	him	
hmf	himself	
I		
imm	immediate	
L		
lr	letter	
ll	little	
M		
mCH	much	
mST	must	
myf	myself	
N		
nec	necessary	
nei	neither	











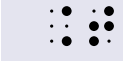
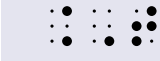

Abbreviation	Word	Braille
O		
ONEf	oneself	⠠⠠⠠⠠⠠⠠
OUrvs	ourselves	⠠⠠⠠⠠⠠⠠⠠
P		
pd	paid	⠠⠠⠠
pERcv	perceive	⠠⠠⠠⠠⠠⠠
pERcvg	perceiving	⠠⠠⠠⠠⠠⠠⠠
pERh	perhaps	⠠⠠⠠⠠
Q		
qk	quick	⠠⠠⠠
R		
rcv	receive	⠠⠠⠠⠠
rcvg	receiving	⠠⠠⠠⠠⠠
rjc	rejoice	⠠⠠⠠⠠
rjcg	rejoicing	⠠⠠⠠⠠⠠
S		
sd	said	⠠⠠⠠
SHd	should	⠠⠠⠠⠠
sCH	such	⠠⠠⠠

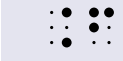

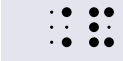
Abbreviation	Word	Braille
T		
THEmvs	themselves	
td	today	
tgr	together	
tm	tomorrow	
tn	tonight	
W		
wd	would	
X		
xs	its	
xf	itself	
Y		
yr	your	
yrf	yourself	
yrvs	yourselves	

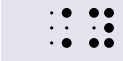
## Appendix 2.4 Greek alphabet

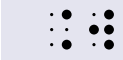
Lowercase			Uppercase	
alpha	α		A	
beta	β		B	
gamma	γ		Γ	
delta	δ		Δ	
epsilon	ε		E	
zeta	ζ		Z	
eta	η		H	
theta	θ		Θ	
iota	ι		I	
kappa	κ		K	
lambda	λ		Λ	
mu	μ		M	
nu	ν		N	
xi	ξ		Ξ	
omicron	ο		O	
pi	π	or	Π	
rho	ρ		P	

Lowercase			Uppercase	
sigma	$\sigma$		$\Sigma$	
tau	$\tau$		$\Upsilon$	
upsilon	$\upsilon$		$\Upsilon$	
phi	$\phi$		$\Phi$	
chi	$\chi$		$\Chi$	
psi	$\psi$		$\Psi$	
omega	$\omega$		$\Omega$	

Appendix 2.5

Braille signs for mathematics

Numerous different encoding systems exist for mathematical braille and are used in different countries. Make sure that you use the encoding system used in your country. The University of Athens has a useful reference list: <https://access.uoa.gr/mathbraille/index.php/en/>

The table below contains signs used in Unified English Braille, Standard English Braille (previously used in Britain), and Nemeth (previously used in the United States). It does not contain all the many mathematical notations used in other forms of braille. See the references in **More information** for a more complete list.

		Unified English Braille	British	Nemeth
Numbers				
#	number prefix			
1				
2				
3				
4				
5				
6				
7				
8				
9				
0				
259				
.	decimal point			
,	thousands separator			
	space			
	line continuation			

		Unified English Braille	British	Nemeth
<b>Operators</b>				
+	plus			
-	minus			
×	multiplied by			
.	multiplication dot			
÷	divided by			
/	divided by, fraction			
:	ratio			
±	plus or minus			
<b>Comparisons</b>				
=	equals			
≠	not equal to			
>	greater than			
<	less than			
≥	greater or equal to			
≤	less or equal to			
≈	approximately equal to			
<b>Mode indicators</b>				
	grade 1 indicator (next sign is a letter, not a number)			
	whole word is grade 1			
	whole passage is grade 1			
	grade 1 terminator			
	grade 1 passage indicator on a line of its own			
	grade 1 passage terminator on a line of its own			

	Unified English Braille	British	Nemeth
<b>Measures</b>			
¢ cent			
\$ dollar			
€ euro			
£ pound			
% percent			
° degree			
' foot, minute			
" inch, second			
<b>Brackets</b>			
( open brackets			
) close brackets			
[ open square brackets			
] close square brackets			
{ open curly brackets			
} close curly brackets			
<b>Roots and exponentials</b>			
√ square root			
√ open root sign with vinculum			
∛ cube root			
tally			
superscript	(or  after a letter)		
subscript	(or  after a letter)		
! factorial			

		Unified English Braille	British	Nemeth
Calculus				
$\int$	integral	⠠⠠⠠⠠⠠⠠	⠠⠠⠠⠠	⠠⠠⠠⠠
$dy/dx$	differential	⠠⠠⠠⠠⠠⠠⠠⠠⠠⠠⠠⠠⠠⠠⠠⠠		
Statistics				
$\bar{x}$	x bar (mean)	⠠⠠⠠⠠⠠⠠		
$\sigma$	Small sigma (standard deviation)	⠠⠠⠠⠠		
$\Sigma$	Capital sigma (sum)	⠠⠠⠠⠠⠠⠠		
Logarithms				
$\log$		⠠⠠⠠⠠⠠⠠	⠠⠠⠠⠠	⠠⠠⠠⠠⠠⠠
$\ln$		⠠⠠⠠⠠		
Geometry				
$\cos$		⠠⠠⠠⠠⠠⠠	⠠⠠⠠⠠	⠠⠠⠠⠠⠠⠠
$\sin$		⠠⠠⠠⠠	⠠⠠⠠⠠	⠠⠠⠠⠠⠠⠠
$\tan$		⠠⠠⠠⠠⠠⠠	⠠⠠⠠⠠	⠠⠠⠠⠠⠠⠠
$\parallel$	parallel to	⠠⠠⠠⠠	⠠⠠⠠⠠	⠠⠠⠠⠠
$\perp$	perpendicular to	⠠⠠⠠⠠	⠠⠠⠠⠠	⠠⠠⠠⠠
$\angle$	angle	⠠⠠⠠⠠⠠⠠	⠠⠠⠠⠠	⠠⠠⠠⠠
$\text{L}$	right angle			⠠⠠⠠⠠⠠⠠⠠⠠⠠⠠

		Unified English Braille	British	Nemeth
<b>Shapes</b>				
	shape indicator	⠠⠠		⠠⠠
	shape termination	⠠⠠		
□	square	⠠⠠⠠⠠	⠠⠠	⠠⠠
▭	rectangle			⠠⠠
△	triangle	⠠⠠⠠⠠	⠠⠠	⠠⠠
⬠	pentagon	⠠⠠⠠⠠		⠠⠠
⬡	hexagon	⠠⠠⠠⠠		⠠⠠
⬢	octagon	⠠⠠⠠⠠		⠠⠠
▯	parallelogram	⠠⠠⠠⠠⠠		⠠⠠
◯	circle	⠠⠠⠠	⠠⠠	⠠⠠
<b>Sets</b>				
∈	is an element of	⠠⠠	⠠⠠	⠠⠠
∋	contains		⠠⠠	⠠⠠
⊂	subset	⠠⠠	⠠⠠	⠠⠠⠠
⊃	superset		⠠⠠	⠠⠠⠠
∩	intersection	⠠⠠	⠠⠠	⠠⠠
∪	union	⠠⠠	⠠⠠	⠠⠠
∅	empty set		⠠⠠	⠠⠠



## More information

### Unified English Braille

APH. UEB math tutorial. <https://uebmath.aphtech.org/>

de Boekhorst, C., M. van de Griend, G.W. Kutosi, A. Mbangeni, P. Mundy, S. Subeh, and A. Withagen. 2023. Teaching braille: A manual for teachers, parents and decision makers. Royal Visio, Netherlands.

Harland, H., and C. Roberts. Unified English Braille for math for sighted learners. <https://studylib.net/doc/18492096/unified-english-braille-for-math-for-sighted-learners>

Howse, J. 2019. Unified English Braille training manual: Introductory mathematics. UEB Online. Accessible Braille Training. NextSense, North Rocks, NSW, Australia. <https://uebonline.org/wp-content/uploads/2022/01/Unified-English-Braille-Training-Manual-Introductory-Mathematics-First-Edition-Rev7.pdf>

Howse, J. 2019. Unified English Braille training manual: Advanced mathematics. UEB Online. Accessible Braille Training. NextSense, North Rocks, NSW, Australia. <https://uebonline.org/wp-content/uploads/2021/05/Unified-English-Braille-Training-Manual-Advanced-Mathematics-First-Edition-Rev6.pdf>

Howse, J. 2020. Unified English Braille training manual – Extension mathematics. UEB Online. Accessible Braille Training. <https://uebonline.org/wp-content/uploads/2021/05/Unified-English-Braille-Extension-Maths-Training-Manual-First-Edition-Rev-4.pdf>

ICEB (International Council on English Braille). 2013. The rules of Unified English Braille. <https://iceb.org/Rules%20of%20Unified%20English%20Braille%202013.pdf>

ICEB (International Council on English Braille). 2014. Unified English Braille. Guidelines for technical material. [http://www.iceb.org/guidelines\\_for\\_technical\\_material\\_2014.pdf](http://www.iceb.org/guidelines_for_technical_material_2014.pdf)

UEB Online. Accessible Braille Training. Cheat sheets. <https://uebonline.org/resources/cheat-sheets/>

UEB Online. Accessible Braille Training. UEB mathematics resources <https://uebonline.org/resources/ueb-mathematics-resources/>

Wikipedia. [https://en.wikipedia.org/wiki/English\\_Braille#Unified\\_Englsh\\_Braille](https://en.wikipedia.org/wiki/English_Braille#Unified_Englsh_Braille)

### British Braille

Braille Authority of the United Kingdom. 2005. Braille mathematics notation. Royal National Institute of the Blind, Peterborough. <https://chezdom.net/wp-content/uploads/2008/07/bmn.pdf>

### Nemeth

APH. Nemeth tutorial. <https://nemeth.aphtech.org/>

Pearson: Accessibility for assessments. Welcome to the Nemeth Symbol Library. <https://accessibility.pearson.com/resources/nemeth-curriculum/nemeth-symbol-library/index.php>

Wikipedia. [https://en.wikipedia.org/wiki/Nemeth\\_Braille](https://en.wikipedia.org/wiki/Nemeth_Braille)

### International

University of Athens. Math braille codes repository <https://access.uoa.gr/mathbraille/index.php/en/>

### Slate and stylus

Grillot, L., and L. Weilbacher. Slate and stylus 101.

<https://www.aph.org/access-academy-handouts/slate-and-stylus-101/>

Wikipedia. Slate and stylus. [https://en.wikipedia.org/wiki/Slate\\_and\\_stylus](https://en.wikipedia.org/wiki/Slate_and_stylus)

Braille Adventures. 10 different types of braille slates.

<https://www.youtube.com/watch?v=M6mUNyj3WRM>

Pao Bencamino. How to use braille slate and stylus. <https://www.youtube.com/watch?v=A2bDR6daHW8>

### Perkins brailier

American Printing House. Cool tech for reading and writing braille.

<https://braillebug.org/braille/braille-technology/>

Goertz, G., T. den Dulk and S. Goedvolk. 2011. Teaching braille. Handouts for course taught in Ghana. Visio, Netherlands.

Inbaf.ie. The Perkins Brailier operating instructions. Visual Impairment Center for Teaching and Research, School of Education, University of Birmingham. <http://inbaf.ie/perkins-brailier/>

Perkins School for the Blind. SMART Brailier. <https://brailier.perkins.org/pages/smart-brailier>

Statewide Vision Resource Centre, Australia. 2013. Introduction to the Perkins brailier.

[www.youtube.com/watch?v=kQmCUAGG-zs](http://www.youtube.com/watch?v=kQmCUAGG-zs)

### Mountbatten brailier

Mountbatten brailier. <https://mountbattenbrailier.com/mountbatten/>

Harpo Sp. 2010. Mountbatten easy guide. A professional development program for the Mountbatten brailier. Workshop one.

Mountbatten Brailier: Introductory video: <https://www.youtube.com/watch?v=gUhlF44h0jw>

Mountbatten Braille Whisperer: Introductory video <https://www.youtube.com/watch?v=X5NLT3yWpiE>

Instructional videos <https://mountbattenbrailier.com/support/>

### Braille notetakers

American Printing House. Cool tech for reading and writing braille.

<https://braillebug.org/braille/braille-technology/>

BrailleNote Touch <https://www.humanware.com/microsite/bntouch/index.php>

### **Embossers**

Library of Congress. National Library Service for the Blind and Print Disabled. Braille embossers. <https://www.loc.gov/nls/resources/blindness-and-vision-impairment/devices-aids/braille-embossers/>

<https://viewplus.com/>

<https://www.indexbraille.com/>

<https://www.everydaysight.com/braille-printers-embossers/>

TactileView. Software to create tactile graphics. <https://www.tactileview.com/>

### **Braille translators**

American Foundation for the Blind. Braille translators. <https://www.afb.org/blindness-and-low-vision/using-technology/assistive-technology-products/braille-translators>

Duxbury systems <https://www.duxburysystems.com/>

RNIB. Transcribing text to braille. <https://www.rnib.org.uk/braille-and-other-tactile-codes-portal-writing-and-producing-braille/transcribing-text-braille>

### **Free online translators**

<https://www.brailletranslator.org/>

<https://wecapable.com/braille-translator/english-to-braille-converter/>

<https://www.mathsisfun.com/braille-translation.html>

<https://www.branah.com/braille-translator>

### 2.13

#### Cube frame or cubarithm

Useful for: Blind

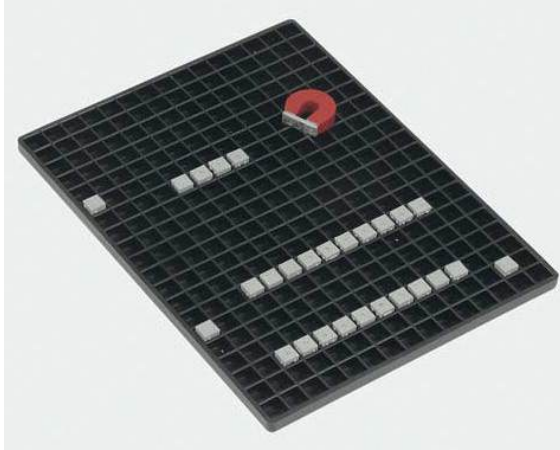

Cube frame or cubarithm. The magnet is used to remove type from the frame.

A cube frame, or cubarithm, is a workboard with a grid of square cells measuring 10 × 10 mm. It is similar to braille. It can be used for similar exercises to the **Taylor frame**.

#### 2.13.1

##### Arithmetic cubes

Each cell can hold a single plastic cube (measuring 9 × 9 × 9 mm) which has embossed dots or a dash. Each face of the cube has a different pattern of dots. The cubes are made of plastic but contain a magnet to make them easy to remove them from the workboard.

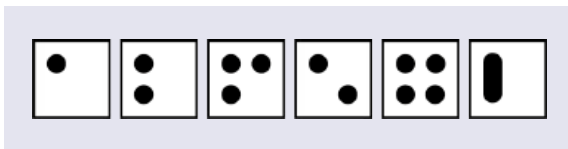

The six faces of an arithmetic cube. Each of these can be rotated 90 degrees to form a different character.

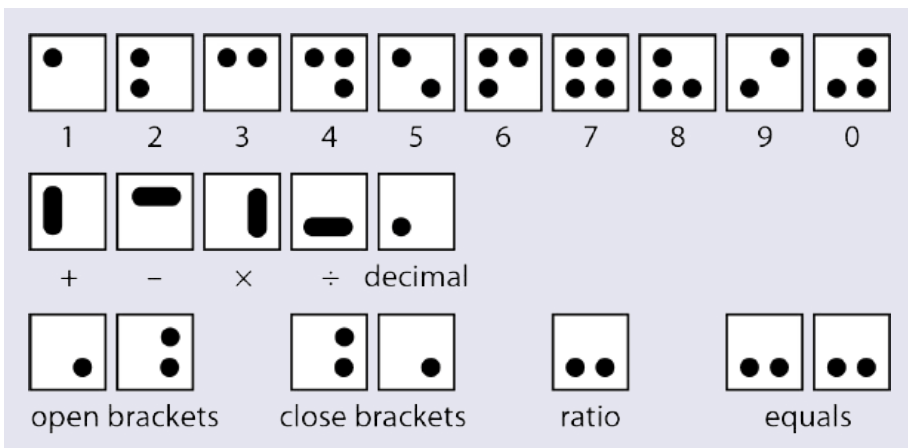

The full set of arithmetic characters in a cube frame.

All the cubes are identical. They can be placed in the holes with any of the six faces upwards, and this face can be put in four different orientations by rotating it by 90, 180 or 270 degrees.

Ten of the positions are used to represent the numbers 1 to 9 and 0. These are easy for a braille reader to recognize as they are the same as the letters **a-j** in braille, or the numbers 1-9 and 0 without the number symbol. (The cube frame does not use the number symbol.)

The remaining positions are used to denote the decimal point, the arithmetic operators + - × ÷ and : (ratio). Combinations of two cubes are used for brackets and the equals sign. Some of these are also similar to the equivalent symbols in braille.

**2.13.2**

**Algebraic cubes**

The algebraic cubes (available separately) have three square layers that can be rotated about a central axis. Each of the faces of these squares contains embossed dots, corresponding to the four possible patterns in braille: one dot on the left, one dot on the right, two dots, or no dots. The squares can be rotated to form any of the 64 braille signs.



Cube frame algebraic cubes.

This makes it possible to use the cube frame to write words, do crosswords, or do algebra and other forms of mathematics using braille.

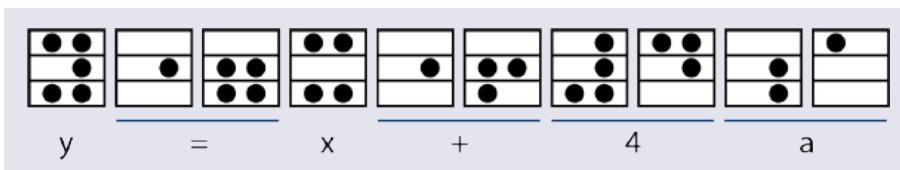

Algebra using the cube frame algebra cubes. This equation reads  $y = x + 4a$ .

**2.13.3**

**Introducing the cube frame**

**Dexterity exercises**

Give the cube frame to the learner and let them explore it with their fingers. They should find out how many rows and columns it has.

Then give the learner the cubes and get them to practise putting them into the frame.

Ask the learner to:

- Put the cubes in at random, then in lines or patterns.
- Set rows, columns or blocks of cubes with specific dot patterns and orientations.

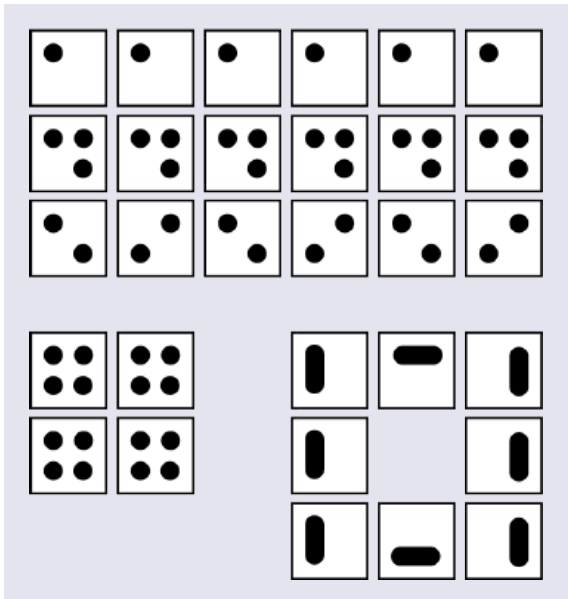

Examples of patterns to practise on the cube frame.

### Handling the cubes

Explain that the cubes are like dice, with a different pattern on each face. Get the learner to detect these patterns and learn how to distinguish them. The easiest way is to hold the cube between the thumb and middle finger with the bar on the thumb and the tip of the middle finger on the opposite face, which has four dots (the 7 symbol). The cube can then be rotated, and the other faces (which all represent numbers) can be felt easily with the tip of the index finger.

Show the learner how to change the orientation of a cube that has been set in the frame by pulling it part-way out of the hole, rotating it and putting it back into the hole.

The learner should learn how to hold a number of cubes in the palm of the hand and hold them in place with the ring and little fingers. They can then use the thumb, index and middle fingers to orient and place the cube with one hand. That will leave the other hand (the best reading hand) free to read the cubes that have already been put in place in the board.

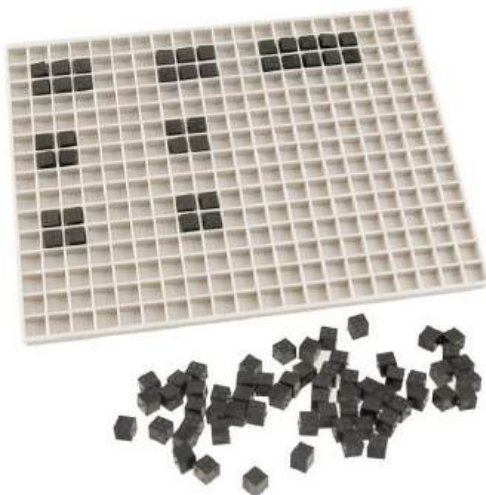

Cube frame with arithmetic cubes.

## Numbers

Explain the meaning of the dots, and help the learner understand that they are (mostly) the same as in braille.

Get the learner to set cubes to represent certain numbers: single-digit numbers, then two- and three-digit numbers.

## Arithmetic

Introduce the meaning of the  symbol and its various orientations: + - × and ÷.

Introduce the equals sign .

Get the learner to practise setting equations, starting with simple addition and subtraction.

Show the learner how to set sums using long arithmetic. Show them how to set the units, tens and hundreds in the correct columns.

## Fractions and decimals

Show the learner how to set fractions and how to use the decimal point.

## Algebra

Once the learner has mastered basic arithmetic on the cube frame, the algebraic cubes can be introduced.

### 2.13.4

#### Using the cube frame

##### Simple arithmetic

The cube frame can be used to make simple equations. See the section on the **Taylor frame** for ideas for exercises.

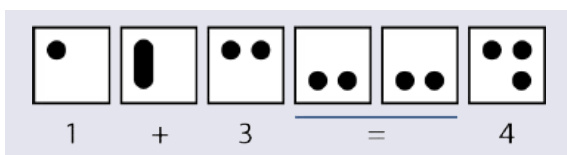

A one-line equation in the cube frame.

##### Long arithmetic

The cube frame can also be used for long forms of addition, subtraction, multiplication and division. The units, tens and hundreds must be aligned in columns, just as in plaintext arithmetic. Put operators such as +, -, × and = to the right rather than to the left of the figures. You can span a rubber band around the cube frame to the right to the units column to help the student find the right location.

All calculations (except for division) should be done on the right side of the frame, starting on the second row.

See the section on the **Taylor frame** for ideas for exercises.

A 3x3 grid of dice faces showing numbers 1 through 9. To the right is a vertical bar representing a decimal point. Below the grid is a multiple-line sum in the cube frame:

1	2	3	+
4	5	6	=
5	7	9	

A multiple-line sum in the cube frame.

### Fractions

Fractions are written with the numerator and the denominator set in separate rows, one above the other. Mixed fractions (like  $1\frac{1}{2}$ ) are set with a space between the whole number and the fraction.

Two examples of fractions on the cube frame. The left example shows a fraction with numerator 3 and denominator 4, separated by a horizontal line. The right example shows a mixed fraction with a whole number 2 and a fraction with numerator 3 and denominator 10, separated by a space.

Fractions on the cube frame. On the left:  $\frac{3}{4}$ . On the right:  $2\frac{3}{10}$ .

### Decimals and brackets

A sequence of dice faces representing the mathematical expression  $(3.5 \times 2) + 4$ . The faces are arranged as follows: a horizontal line, an opening parenthesis, a die with 3 dots, a decimal point, a die with 5 dots, a multiplication sign, a die with 2 dots, a closing parenthesis, a horizontal line, a plus sign, and a die with 4 dots.

An expression using brackets and a decimal.



### More information

Worldwide Vision. Cubarithme [https://www.worldwidevision.nl/gfx/product\\_file/349902\\_Eng.doc](https://www.worldwidevision.nl/gfx/product_file/349902_Eng.doc)

### Video

<https://www.eurobraille.fr/produit/cubarithme/>

### Buy

APH. Cubarithm. [https://www.aph.org/search-results/?fwp\\_search\\_term=cubarithm](https://www.aph.org/search-results/?fwp_search_term=cubarithm)

Ceciaa.com. Plateau arithmétique Cubarithme pour aveugle. <https://www.cecias.com/cubarithme.html>

Maxiaids. Braille math teaching slate and cubes kit for blind and low vision. <https://www.maxiaids.com/braille-math-teaching-slate-and-cubes-kit-for-blind-and-low-vision>

RNIB. Cubarithm arithmetic board. <https://shop.rnib.org.uk/cubarithm-arithmetic-board>

Walmart. <https://www.walmart.com/ip/Braille-Math-Teaching-Slate-and-Cubes-Kit-for-Blind-and-Low-Vision/118658372>

## 2.14

### Taylor frame

#### Useful for: Blind

The Taylor frame is a frame with a plastic or metal pegboard containing a grid of eight-pointed holes. It comes with a set of metal or plastic pegs, or “type”. These have a square cross-section that fits into the holes. By rotating a peg by 45 degrees at a time, it can be fitted into hole in any one of eight different orientations.

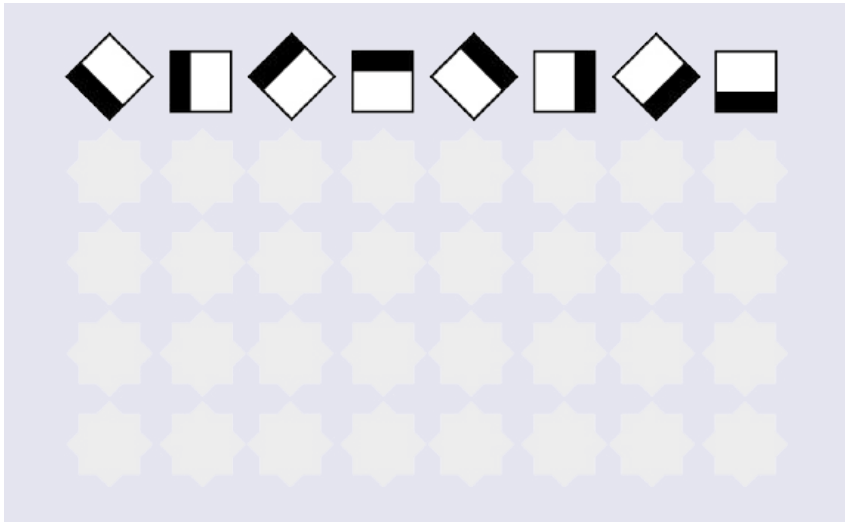

A Taylor frame has a grid of eight-pointed holes. The pegs, or “type”, can be rotated to fit in these holes in eight different orientations. The form and orientation of the type carries the meaning. The diagram above reads 12345678.



Wood-and-metal Taylor frame with metal type.



Taylor frame and type made from plastic.

The ends of the type have different shapes that can be felt with the fingertips. There are two forms of type: arithmetic and algebra.

**Arithmetic type** has a straight line on one end, and two dots on the other end. These pegs are used to represent the numbers 1-0, plus the operators + -  $\times$  and  $\div$ , the decimal point, and =. The meaning of each piece of type depends on which end is at the top and its orientation in the hole.

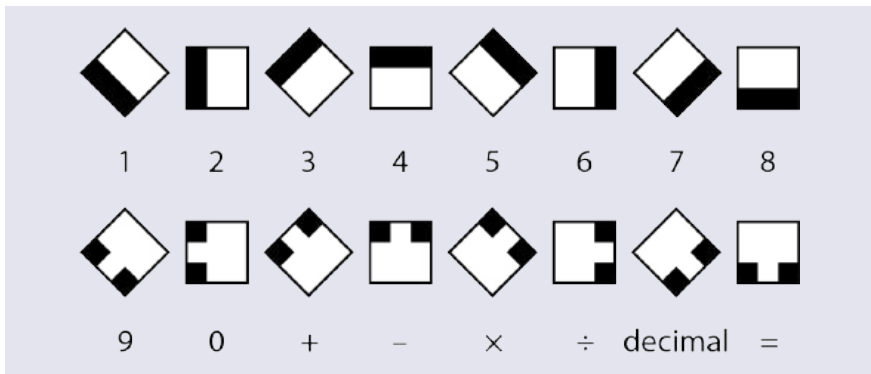

Arithmetic type. The black areas are raised, so can be felt with the fingertips

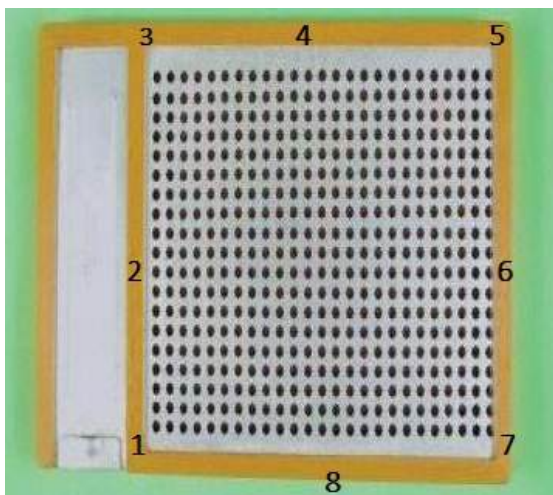

You can write the numbers 1-8 on the edges of the Taylor frame. That makes it easier to remember the correct pattern.

**Algebra type** is used to represent unknowns (**a, b, c, d, x, y, z** and **n**), brackets, powers and roots. The type has an L-shape at one end and a triangle at the other end.

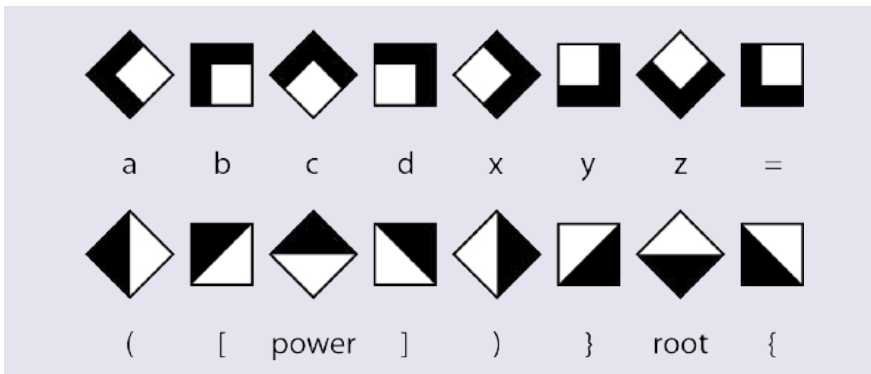

Algebra type. The black areas are raised, so can be felt with the fingertips.

The following pairs are mirror images of each other

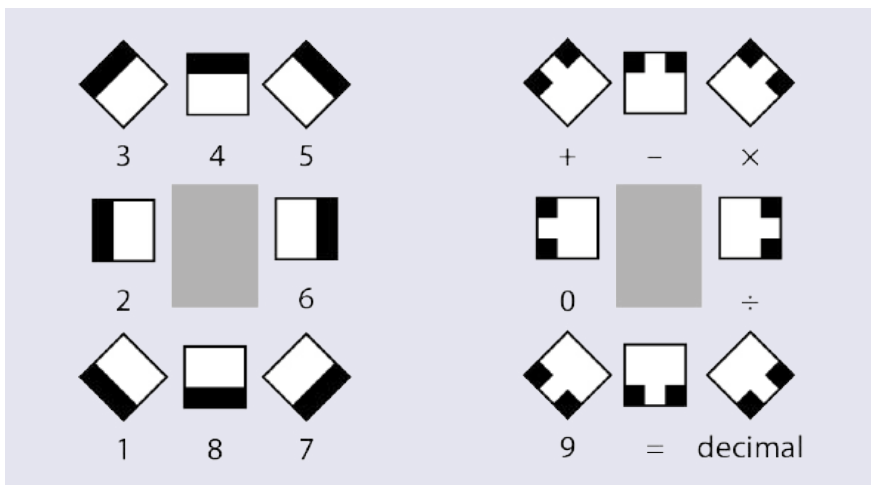
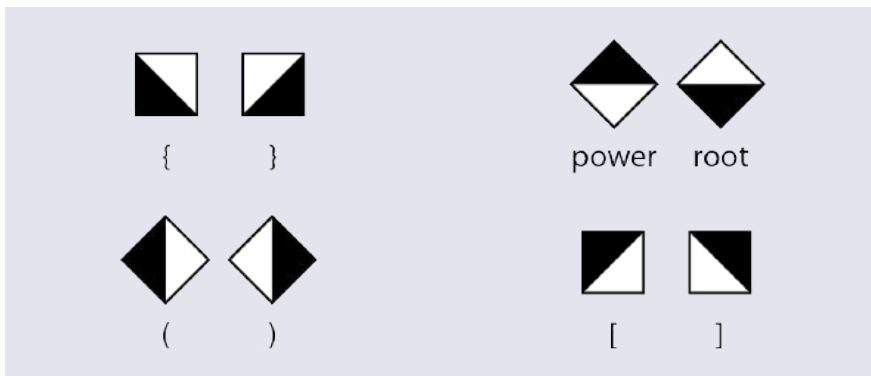

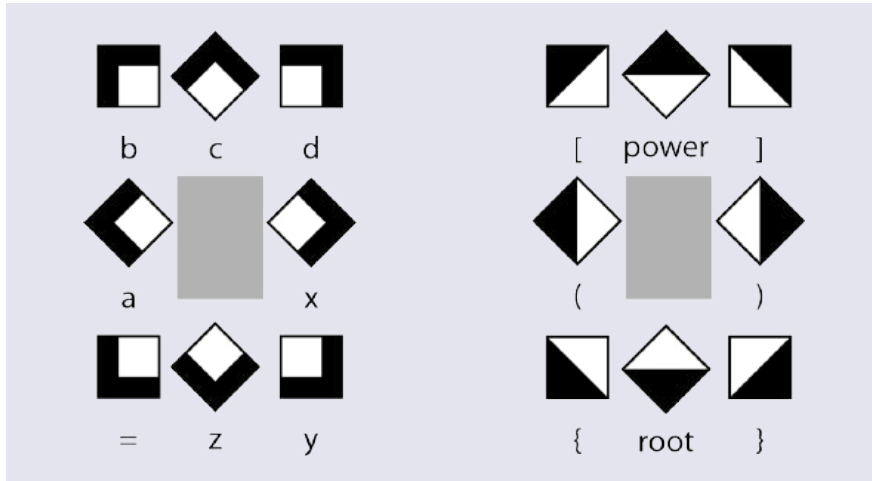

The Taylor frame type fits into easily remembered patterns.

The Taylor frame can be used for a wide range of mathematics subjects, including natural numbers, fractions, decimals, algebra, indices, squares and roots of numbers, cartesian co-ordinates, integers, matrices, vectors, polygons, quadratic equations, inequalities, sets, and functions. It can even be used to teach geometry by spanning rubber bands around pegs in the board to make rectangles, triangles, etc.

#### 2.14.1

##### Introducing the Taylor frame

Some of the steps below may take a long time to master. Others can be grasped fairly quickly.

Introduce the Taylor frame and the arithmetic to the learner. Allow them to explore the frame and become familiar with the type. Explain the two ends of the type (with a line or two dots), and show them how to fit the type into the holes.

##### Dexterity exercises

Start with dexterity exercises. For example, ask the learner to:

- Fill the top row with type, but not to worry about the orientation.
- Fill a column with type with any orientation.
- Fill a row with type with all the same orientation, such as all horizontal.
- Fill a row with type alternating between horizontal and vertical bars.
- Fill a row with type rotated 45 degrees each time.
- Make shapes such as squares, circles and triangles with type.

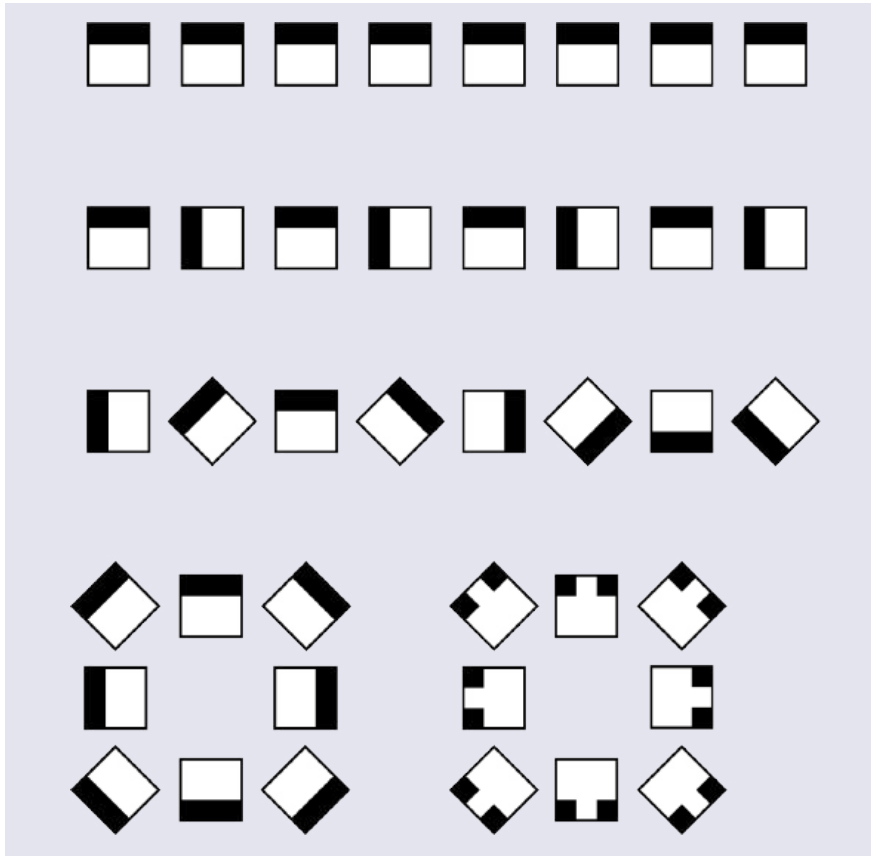

Examples of patterns to practise on the Taylor frame.

### Numbers

Once the learner has reached a certain level of dexterity, introduce the meanings of the **numbers 1-8**.

Ask them to set (and read):

- Selected single-digit numbers, such as 1, 3, 6 and 8
- Two- and three-digit numbers, such as 11, 111, 123, 531, 28

Introduce the numbers **9 and 0**. Ask them to set (and read):

- A row with all 0s
- A row with alternating 0s and 9s: 0909090...
- Random numbers between 0 and 1,000

### Simple arithmetic

Introduce the **arithmetic operators + and -, and the = sign**. Ask the learner to set (and answer) simple addition and subtraction sums such as the following. If possible, introduce these skills at the same time as teaching the equivalent to sighted members of the class.

- $1 + 1 =$
- $2 + 5 =$
- $5 + 7 =$
- $9 - 4 =$
- $15 - 8 =$

Introduce the **arithmetic operators  $\times$  and  $\div$** . Ask the learner to set (and answer) simple multiplication and division problems, such as:

- $4 \times 2 =$
- $3 \times 3 =$
- $4 \times 5 =$
- $8 \div 2 =$
- $18 \div 9 =$

### Long arithmetic

Introduce **long addition**. Show the learner how to set out the numbers under each other so the units, tens and hundreds align vertically. Show how to set the answer in the row below the numbers to be added. Stretch a rubber band across the Taylor frame to mark the units column, then ask the learner to set the numbers from right to left: units, then tens, then hundreds. This makes it easier to keep the columns aligned.

All calculations (except for division) should be done on the right side of the frame, starting on the second row.

Introduce long **subtraction, multiplication and division** in turn.

### Algebra

Introduce the **algebra** type. Explain how to set (and solve) algebraic expressions and equations.

### Using the Taylor frame

The examples below show that the Taylor frame can be used to work out mathematical problems in almost all topics.

#### Arithmetic (single line)

3   +   5   =   8                      3+5=8

#### Decimals

1   2   decimal   5                      12.5

Arithmetic (several lines)

6 9 4  
+ 8 7  
7 8 1

rubber band

+

=

$$\begin{array}{r} 694 \\ + 87 \\ \hline 781 \end{array}$$

Stretch a rubber band across the Taylor frame to help the learner locate the zeros column. Put the operators such as + and = to the right side of the rubber band. This avoids having to calculate how much space to leave for the operators on the left side.

Long division

1 8 6  
÷ 1 2  
1 5 5  
0

rubber band

÷

=

Use rubber bands to help the student find their place in the sum.

Algebra

$x + y = 3$

$x+y=3$

Powers

$x$  power  $2$

$x^2$

Quadratic equations

$x^2 + 3x + 2$

$x^2+3x+2$

Vectors

$\begin{pmatrix} 2 \\ 3 \end{pmatrix}$

$\begin{pmatrix} 2 \\ 3 \end{pmatrix}$



Matrices

( - 1 )      ( -1, 0 )  
 ( 4 - 4 )      ( 4, -4 )

Use blank columns to separate elements in the matrix

Sets

a = ( 1 | 2 | 3 )  
 a={1, 2, 3}

The Taylor frame uses empty cells instead of commas.

Cartesian coordinates

The numbers 0–7 are used to show the x and y axes. The type is used to show the location of the points in the graph. The points can be joined by rubber bands to make a line. This graph shows points at (3,3) and (6,6).

Centre the axes in the Taylor frame to make a graph with all four quadrants.

### Polygons

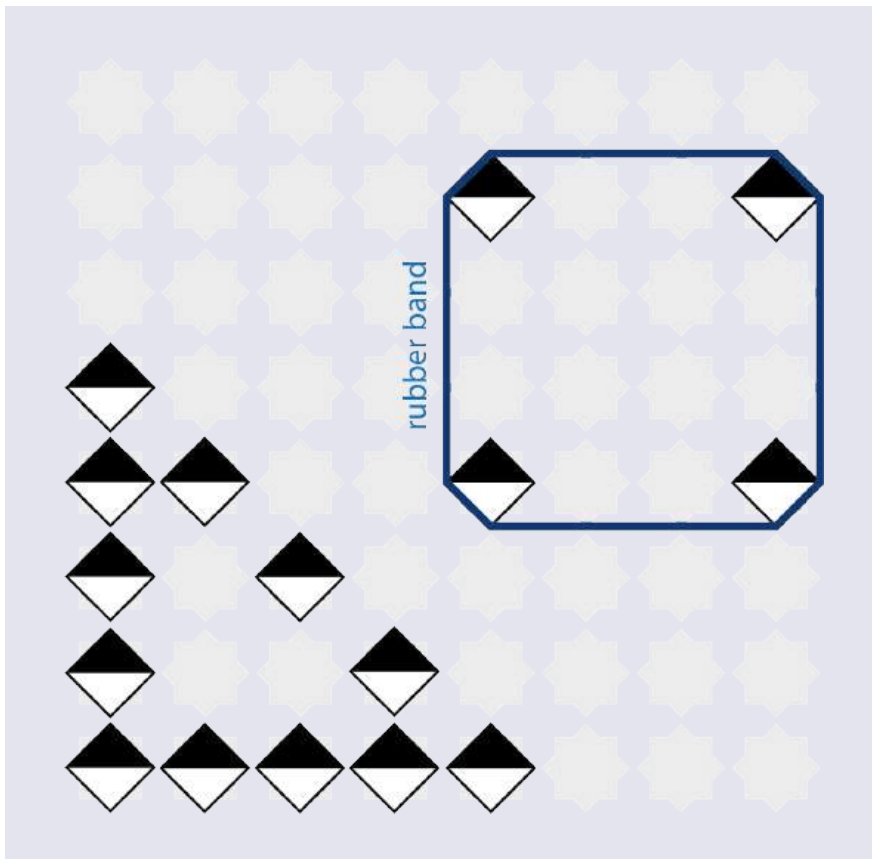

You can use a Taylor frame as a geoboard (see **Drawings and graphs**). Make polygons using type for the edges, or (simpler) put a piece of type at each corner and stretch rubber bands around them to form the shape.

You can also use rubber bands or cut-out rings of cardboard to teach topics such as sets.

#### 2.14.2

##### Advantages and disadvantages

Learning how to use the Taylor frame is difficult and time-consuming for both the teacher and the student. If you decide to use it for teaching, you will need to invest time to learn it yourself, and then to teach it to the student. This is worthwhile only if you intend to use it for an extended period (for example, to teach several different topics in maths). But once learned, the Taylor frame can be a very useful and versatile tool.

Unlike alternatives such as the abacus, the Taylor frame allows the learner to read and write at the same time. The steps of working can be laid out line by line, making it easy to review and correct work. It gives the teacher and learner the possibility to check the working of equations.

The Taylor frame requires the learner to learn a new "language": the meanings of the different forms and orientations of the type. Some learners find the Taylor frame too abstract. But once they have mastered the language, the Taylor frame becomes a very useful tool.

Placing the type in the Taylor frame is tedious and time-consuming. Correcting errors (such as putting a row of type in the wrong columns) takes time. But it practises manual dexterity and accuracy.

If the teacher knows how to use the Taylor frame, they can check the learner's work directly. This is best done immediately. If not, the work must be transcribed by the student (to braille) or by a teaching assistant. If more than one Taylor frame is available, the learner can work on another exercise without having to dismantle the previous one.

The information set on the Taylor frame is temporary (unlike printed braille). The student or assistant will have to transcribe the exercise to make a permanent record. This is time-consuming.

To do another exercise, the learner turns the Taylor frame upside down to remove the type. They must then find the correct type again: distinguishing arithmetic from algebra type, finding the right end of the type, and then place it in the frame in the correct position and orientation.

The type is small and easily swallowed, so is not suitable for small children. The type can get lost over time, so an adequate supply is needed.

Older type is made of lead, which is poisonous. Do not use lead type, or if there is no alternative, insist that the learner keeps the type away from their mouth and washes their hands after using it.

### More information

#### Video

GPS Rikhar Kalsi DDun. Special child learning mathematics with Taylor frame.

<https://www.youtube.com/watch?v=l-c57UBio6o>

Dr. sree priya. R. Taylor frame: An introduction. <https://www.youtube.com/watch?v=j3ilfqvXu8U>

#### Buy

Advance Engineering Works. <https://www.advancebraille.com>

Maxiaids. Taylors mathematical frame with 100 piece type sets.

<https://www.maxiaids.com/taylors-mathematical-frame-with-100-piece-type-sets-2>

Amazon. <https://www.amazon.in/Advance-Engineering-Arithmetic-Algebra-Braille/dp/Bo8HH6PQDR>

# Part 3

## Teaching specific subjects

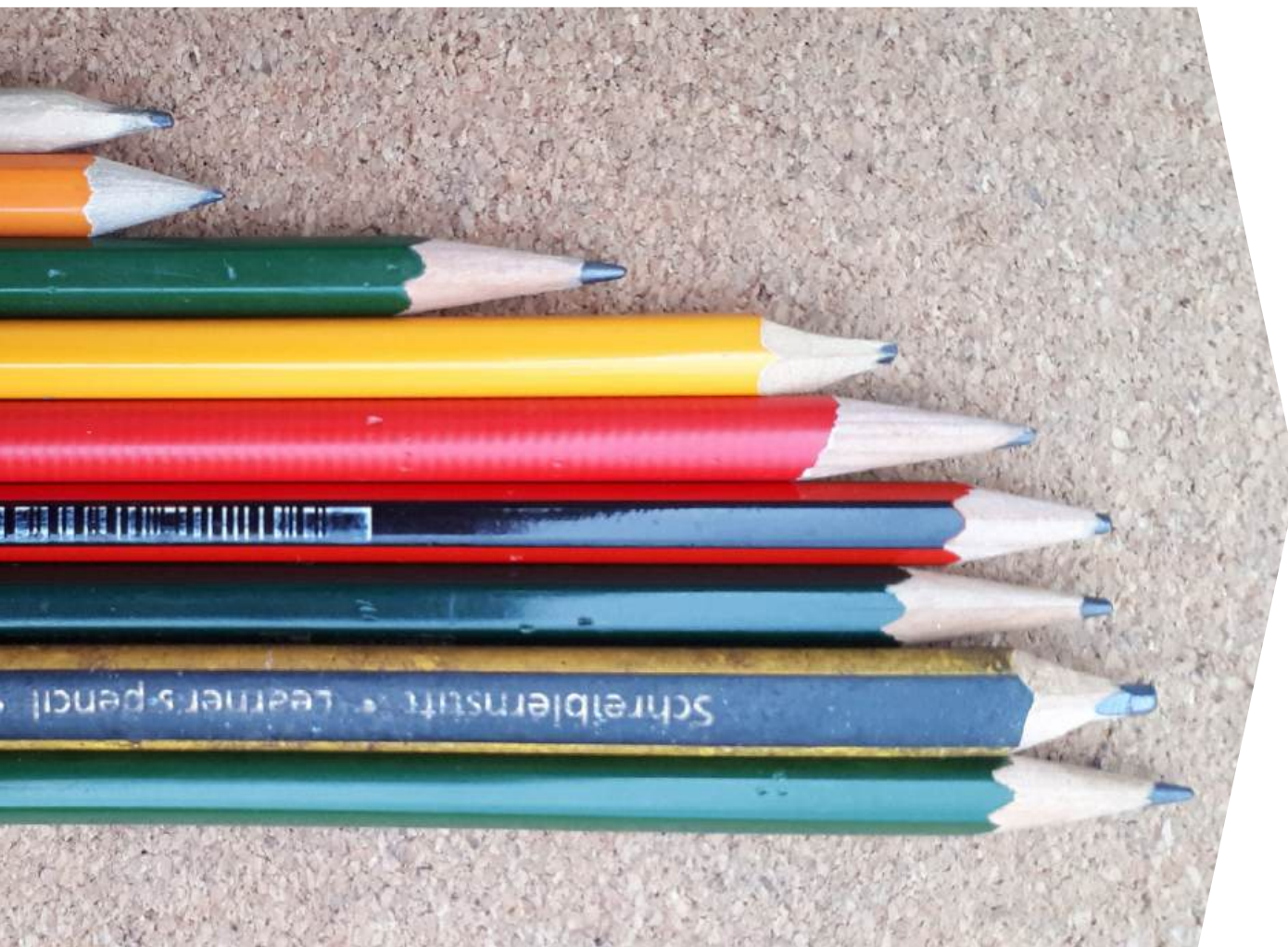

Part 3 describes ways to teach specific advanced maths subjects. It discusses the following:

- Long arithmetic
- Algebra
- Geometry
- Graphs
- Statistics
- Probability
- Tables.

Just as is the case with sighted learners, there are many different ways to teach each of these topics to blind or visually impaired learners. We cover only a selection of methods here.

Some general tips:

- **Adapt to the learner's needs.** Each learner is different, and has a different set of capabilities and needs. Some learners pick up braille quickly; others need more time and practice. You may have to adjust the approach you use, or the speed at which you teach, depending on the individual learner's characteristics.
- **Do not expect more of blind and visually impaired learners** than you would of their sighted classmates. For example, in long addition, sighted learners are taught to write a small 1 below a column of figures to "carry a 1". In long subtraction, they learn to cross out a 4 and replace it with a 3. Blind and visually impaired learners are often expected to remember what to carry or borrow. This is unfair and unrealistic, and leads to more mistakes. Find ways to adapt the calculation methods so that these learners do not have to rely so much on their memory for such tasks. It may be necessary to pre-teach these methods to these learners before the main class activities.
- **Use a variety of methods.** Remember that you are preparing learners for life outside the classroom and after school. The school may have computers and an embosser, but a child, especially one from a poor background, may not have such equipment at home. So they need to learn different ways of doing the same thing: doing calculations in their head, using a calculator, or using a slate and stylus.
- **Use the resources at your disposal.** Do not wait for the Ministry of Education to provide you with a particular piece of equipment. Instead, think of other ways you can teach a subject using the equipment you have available. If you do not have a tactile ruler, you can make one out of a sheet of plastic. Be creative!
- **Build on what works.** Find out what works (and what does not work) in your situation, and build on that knowledge.
- **Communicate with other teachers.** This is particularly important when working with blind and visually impaired learners. Compare notes with other teachers on what they are teaching and the techniques they use. Because maths is the basis for other science and technology subjects, work especially closely with teachers of these subjects.

### 3.1

#### Long arithmetic

Useful for: Blind, Low vision, Sighted

Long arithmetic can be a problem for blind and visually impaired learners because it involves several rows of figures which have to be matched vertically in columns. For blind learners using braille, a cube frame or Taylor frame, they must first feel the numbers with their fingertips, then perform the calculations and find the right place to enter the solution. It is very easy to lose one's place or skip a step, and it is difficult to check back what they have already done. Visually impaired learners using large print may find it difficult to scan an entire sum.

Conventional methods teach the students to write small numbers to "carry a 1" in addition problems, or "borrow a 1" in subtraction, and to cross out and replace numbers in subtraction. This can be difficult for visually impaired learners, and is not possible in braille.

$$\begin{array}{r} 584 \\ + 347 \\ \hline 931 \end{array}$$

The small numbers used to "carry a 1" are hard to see.

In addition, aligning the columns can be a problem for braille users, especially using a slate and stylus, where it is not possible to read what you have written immediately.

The suggestions below are useful mainly for visually impaired learners (though many can benefit sighted learners too). Some can also be used in braille when using a Perkins braille, as it is possible to read directly what has been embossed, and to reposition the embossing head to write new characters in the desired position. See the section on **Braille** for more ideas for braille users.

### 3.1.1

#### Addition

##### Addition of whole numbers

##### Useful for: Blind, Low vision, Sighted

Use extra space between the numbers to make them easier to read. Align the numbers in columns. Instead of using small numbers to "carry a 1", put them at the top of the calculation. Use colours to make them easier to see.

Make sure the learners understand they should always start on the right side, in the units column, and work to the left.

$$\begin{array}{r} +1 +1 \\ 584 \\ + 347 \\ \hline 931 \end{array}$$

Putting the operation sign + on the right makes the sum easier to lay out, especially in braille. It also means you do not have to work out how much space to leave to align the columns correctly.

$$\begin{array}{r} +1 +1 \\ 584 \\ + 347 \\ \hline 931 \end{array} +$$

Instead of "carrying a 1", calculate each line and write it on a separate line. Then add the figures together to find the solution. This avoids having to go back to the top of the sum for each stage in the calculation.

$$\begin{array}{r}
 5 \ 8 \ 4 \\
 + 3 \ 4 \ 7 \\
 \hline
 1 \ 1 \\
 1 \ 2 \\
 8 \\
 \hline
 9 \ 3 \ 1
 \end{array}$$

**Using a grid**

**Useful for: Low vision, Sighted**

Provide a grid to make it easier for the student to lay out the sum. Teach the student to put the units column on the right side (or one or two columns to the left of this if you put the + sign on the right). Leave a row at the top for the 1s that have been carried.

Use different colours for the carried figures, the operator and the solution to make them easier to see.

	+1	+1	
	5	8	4
+	3	4	7
	9	3	1

You can use highlighters to emphasize the columns or to show where to write the solution.

	+1	+1	
	5	8	4
+	3	4	7
	9	3	1

The student can flip their exercise book horizontally to make columns.

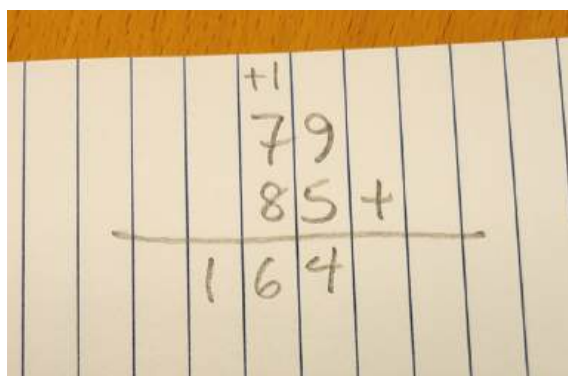

Flip the book 90 degrees to make columns.

**Addition of decimal numbers****Useful for: Low vision, Sighted**

With decimals, it is particularly important to align the numbers correctly. For example, for the sum:

$$11.2 + 13.45$$

it is necessary to add an extra 0 in the hundredths position to keep the figures aligned correctly. Put the decimal point in a column of its own.

1	1	.	2	0		
1	3	.	4	5	+	
2	4	.	6	5		

You can use highlighter to emphasize the columns.

1	1	.	2	0		
1	3	.	4	5	+	
2	4	.	6	5		

**Breaking numbers down****Useful for: Blind, Low vision, Sighted**

Instead of writing the figures in columns, the learner can break down the sum into hundreds, tens and units, then sum up each one separately. Unlike standard long addition, this approach does not start on the right side of the sum.

This approach is especially useful for braille users, as they do not have to move back and forth across the paper. It also works on a braille display.

$$\begin{aligned}
 584 + 347 &= \\
 500 + 300 + 80 + 40 + 4 + 7 &= \\
 800 + 120 + 11 &= \\
 931
 \end{aligned}$$

Use colours to emphasize the working.

$$\begin{aligned}
 584 + 347 &= \\
 500 + 300 + 80 + 40 + 4 + 7 &= \\
 800 + 120 + 11 &= \\
 931
 \end{aligned}$$



Once the learner has mastered this technique, it can be shortened.

$$\begin{aligned}
 584 + 347 &= \\
 800 + 120 + 11 &= \\
 931 &
 \end{aligned}$$

It is possible to compress this to a single line (for example, when using a braille display).

$$584+347=800+120+11= 931$$

**3.1.2**  
**Subtraction**

**Subtraction of whole numbers**  
**Useful for: Low vision, Sighted**

Subtraction is more complicated than addition because it requires the learner to “borrow a 1” and cross out the number in the column to the left and replace it with the same figure minus 1. This can be confusing. It is not possible to add in 1s or cross out numbers in braille.

For visually impaired learners, put the numbers in a grid to help them align the columns correctly. Leave a row at the top to show the borrowings. Colour the operator (-) to emphasize it.

6	7	5		
2	3	8	-	
<hr/>				

	6			
6	<del>7</del>	15		
2	3	8	-	
<hr/>				
4	3	7		

**Subtraction of decimal numbers**  
**Useful for: Low vision, Sighted**

Using a grid and adding in the missing zeros can help the learner avoid common errors.

2	3	.	1	0	
1	8	.	9	2	-
<hr/>					

Leave a row at the top for the workings. Put these in a different colour to avoid errors.

1	12		10		
<del>2</del>	<del>3</del>	.	<del>1</del>	10	
1	8	.	9	2	-
	4	.	1	8	

### Breaking numbers down

Useful for: Blind, Low vision, Sighted

In braille, it may be easier to break the numbers down into hundreds, tens and units, then perform the subtraction.

$$\begin{aligned}
 &675 - 238 = \\
 &600 - 200 + 70 - 30 + 5 - 8 = \\
 &400 + 40 - 3 = \\
 &437
 \end{aligned}$$

This can be shortened to the following. Make sure the learner understands that an expression like  $+ 5 - 8$  becomes  $-3$ . This is a good introduction to negative numbers.

$$\begin{aligned}
 &675 - 238 = \\
 &600 - 200 + 70 - 30 + 5 - 8 = \\
 &400 + 40 - 3 = \\
 &437
 \end{aligned}$$

### 3.1.3 Multiplication

#### Using a grid

Useful for: Low vision, Sighted

Using a grid is especially helpful for multiplication, where it is easy to lose track of where you are in a working.

Instead of writing small numbers for the carried figures, it is easier to write the product of each step in the calculation below the line, then sum them at the end.

	1	4	9	
		4	5	×
		4	5	
	2	0		
	5			
	3	6		
1	6			
4				
6	7	0	5	

Using colours makes this easier to understand.

	1	4	9	
		4	5	×
		4	5	
	2	0		
	5			
	3	6		
1	6			
4				
6	7	0	5	

Adding the zeros in a different colour helps the learner keep the right place in the calculation.

	1	4	9	
		4	5	×
		4	5	
	2	0	0	
	5	0	0	
	3	6	0	
1	6	0	0	
4	0	0	0	
6	7	0	5	

**Breaking numbers down**

**Useful for: Blind, Low vision, Sighted**

Breaking a multiplication problem down into hundreds, tens and units avoids having to lay the figures out in columns. This is useful in braille. The numbers can then be added together in a series of steps.

$$\begin{aligned}
 &149 \times 45 = \\
 &4000 + 1600 + 360 + 500 + 200 + 45 = \\
 &5600 + 860 + 245 = \\
 &6460 + 245 = \\
 &6705
 \end{aligned}$$

Using colours helps show the working. Depending on the numbers, it may be easier to add up different groups of figures in the intermediate steps.

$$\begin{aligned}
 &149 \times 45 = \\
 &4000 + 1600 + 360 + 500 + 200 + 45 = \\
 &5960 + 745 = \\
 &6705
 \end{aligned}$$

$$\begin{aligned}
 &149 \times 45 = \\
 &4000 + 1600 + 360 + 500 + 200 + 45 = \\
 &5600 + 1060 + 45 = \\
 &6660 + 45 = \\
 &6705
 \end{aligned}$$

**3.1.4**

**Division**

The examples below use the notation commonly used in English-speaking countries. Other countries use different notations for division.

**Using a grid**

**Useful for: Low vision, Sighted**

Long division is the most difficult operation in basic arithmetic, which is why it is taught last. Using a grid and colours can help the learner navigate through the problem.

			1	2	4
3	2	3	9	6	8
	-	3	2		
			7	6	
		-	6	4	
			1	2	8
		-	1	2	8
					0

			1	2	4
3	2	3	9	6	8
	-	3	2		
			7	6	
		-	6	4	
			1	2	8
		-	1	2	8
					0

Highlight numbers to show which figures have to be brought down and where to write the answer.

			1	2	4
3	2	3	9	6	8
	-	3	2		
			7	6	
		-	6	4	
			1	2	8
		-	1	2	8
					0

**Answer below**

**Useful for: Blind**

In short division, it may be useful to write the answer below the problem instead of above it, and to put the divisor on the right and the dividend on the left. This is easier for braille users as they do not have to roll the paper back and forth to enter the answer.

<u>208</u>		8	⠠⠠⠠⠠⠠⠠⠠⠠	:	⠠⠠⠠
26			⠠⠠⠠⠠⠠		
			⠠⠠⠠		

Putting the answer below a simple division sum is easier for braille users.

**Breaking numbers down**

**Useful for: Blind, Low vision, Sighted**

You can avoid having to use a graphical layout in long division by breaking the dividend (the number to be divided up). This may be easier for braille users.

3968 ÷ 32
3900 ÷ 32 = 100
760 ÷ 32 = 20
128 ÷ 32 = 4
100 + 20 + 4 = 124

You can use colour to emphasize the working.

$$\begin{aligned}
 &3968 \div 32 \\
 &3968 \div 32 = 100 + \text{R } 768 \\
 &768 \div 32 = 20 + \text{R } 128 \\
 &128 \div 32 = 4 + \text{R } 0 \\
 &100 + 20 + 4 = 124
 \end{aligned}$$

This example uses colour to highlight the items to be added up to get the answer.

$$\begin{aligned}
 &3968 \div 32 \\
 &3968 \div 32 = 100 + \text{R } 768 \\
 &768 \div 32 = 20 + \text{R } 128 \\
 &128 \div 32 = 4 + \text{R } 0 \\
 &100 + 20 + 4 = 124
 \end{aligned}$$

### Using a cheat sheet

#### Useful for: Blind, Low vision, Sighted

If the learner makes a "cheat sheet" – a list of multiples (from 1 to 9) of the divisor – they can avoid having to calculate each multiplication separately. They can then use this to save time and avoid errors when performing the calculation.

	3	2		1
	6	4		2
	9	6		3
1	2	8		4
1	6	0		5
1	9	2		6
2	2	4		7
2	5	6		8
2	8	8		9

### Using DMSBR

#### Useful for: Blind, Low vision, Sighted

"DMSBR" spells out the steps in long division: Divide, Multiply, Subtract, Bring down, and Remainder or Repeat. You can use a mnemonic (a catchy set of words or a phrase) to help the learners remember these steps. You can remember DMSBR as:

- Dad, Mum, Sister, Brother, Ready!
- Dracula Must Suck Blood Regularly
- Does MacDonalds Sell Burgers Raw?
- Did My Sister Buy Rice?

Here are the steps in long division.

$$\begin{array}{r} 3 \\ 15 \overline{) 465} \end{array}$$

Divide

Divide 46 by 15 to give 3.

$$\begin{array}{r} \times 3 \\ 15 \overline{) 465} \\ \underline{45} \end{array}$$

Multiply

Multiply 15 by 3 to give 45.

$$\begin{array}{r} 3 \\ 15 \overline{) 465} \\ \underline{-45} \\ 1 \end{array}$$

Subtract

Subtract 45 from 46 to give 1.

$$\begin{array}{r} 3 \\ 15 \overline{) 465} \\ \underline{-45} \downarrow \\ 15 \end{array}$$

Bring down

Bring down the next number (5)

$$\begin{array}{r} 3 \\ 15 \overline{) 465} \\ \underline{-45} \\ 15 \end{array}$$

Repeat

Repeat using 15 as the dividend.

$$\begin{array}{r} 31 \\ 15 \overline{) 465} \\ \underline{-45} \\ 15 \end{array}$$

Divide

Divide 15 by 15 to give 1.

$$\begin{array}{r} \times 31 \\ 15 \overline{) 465} \\ \underline{-45} \\ 15 \end{array}$$

Multiply

Multiply 15 by 1 to give 15.

$$\begin{array}{r}
 31 \\
 15 \overline{)465} \\
 \underline{-45} \quad \text{Subtract} \\
 15 \\
 \underline{-15} \\
 0
 \end{array}$$

Subtract 15 from 15 to give 0. No more numbers to bring down, and no remainder. The answer is 31.

### 3.1.5

#### Worksheet templates for arithmetic

Useful for: Low vision, Sighted

Many teachers use templates to teach arithmetic. These are shown on the left side of the figures below. The learner writes the numbers in the boxes, then solves the problem.

You can adapt these by using shapes or colours to help visually impaired learners navigate the exercises (on the right side of the figures below). This can be useful for sighted learners too. Be consistent in your use of colours and shapes: always use the same colour or shape for the numbers to be carried, for example.

#### Addition

The red shapes in the top row are for the 1s to be carried (if needed).

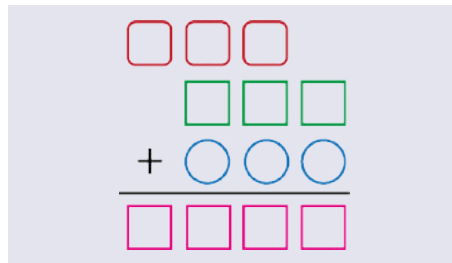
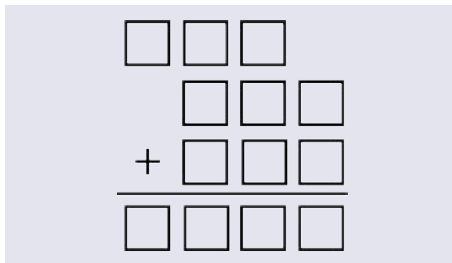

#### Subtraction

The red shapes in the top row are for the borrowings (if needed).

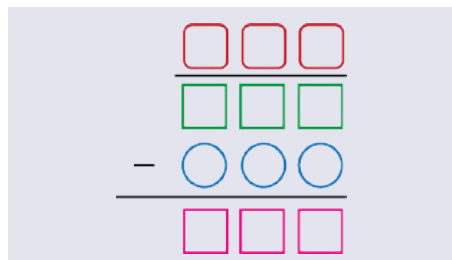
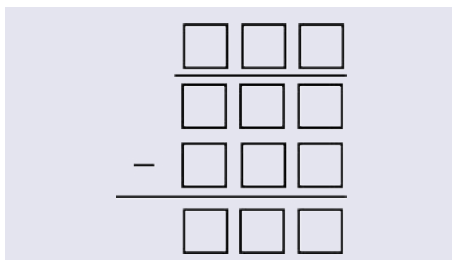



### Multiplication

Here the colours remind the learner to which numbers to multiply by and where to put the answer.

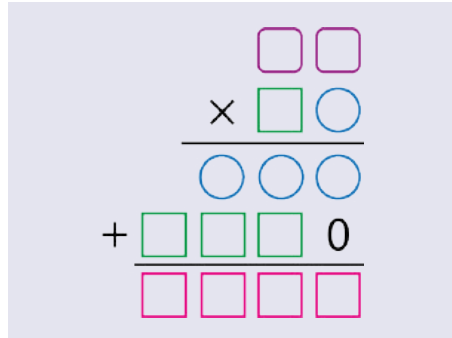
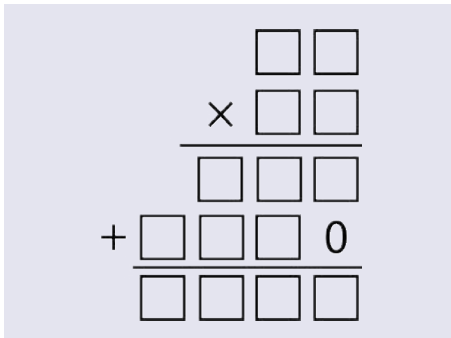

### Division

Here the shapes show the learner where to bring down the next figure, and where to put the answers. The R shows the remainder. The template can be adapted for calculating decimals instead of remainders.

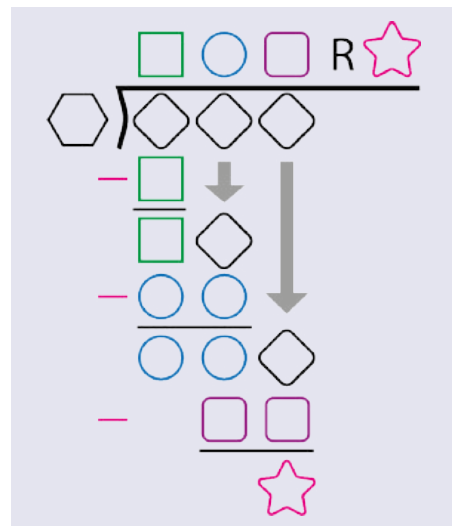
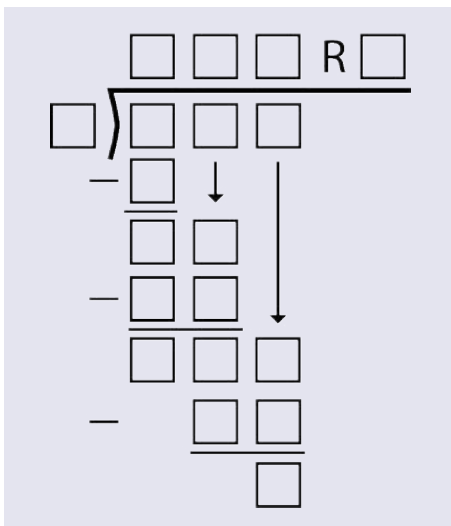

## 3.2 Algebra

In algebra, reading expressions and equations accurately is important. There is a big difference between reading normal text and mathematical text. For example, it is easy to work out what the missing characters are on the left side of the exercise below. It is impossible to know what the missing characters are in the expressions on the right side.

regular text	mathematical text
showr?om	$\frac{1}{3} + \frac{?}{4} =$
edu?at?on	$x^2?5x =$
fl?b?erg?sted	$\sin(2a + ?)=$

## 3.2.1

**Making algebra easier to read**

Useful for: Low vision, Sighted

**Multiplication sign**

Bad:  $x \times x = x^2$   
 Good:  $x * x = x^2$

**Superscripts and subscripts**

Many letters and symbols in maths are written as subscripts ( $x^j$ ) or superscripts ( $e^x$ ). These are smaller than regular letters and symbols. Therefore, in general, you need a bigger font size while reading mathematical text.

A big font size can be a disadvantage, though. A learner with limited vision may be able to see only part of the equation at any one time. They will find it difficult to get a view of the equation as a whole.

So the guidance is this: make the font as big as necessary, but as small as possible.

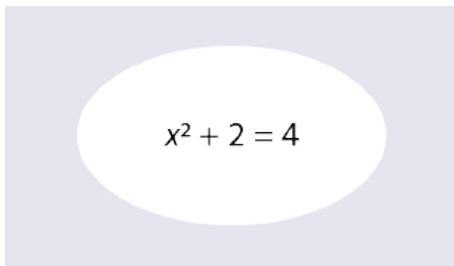

$$x^2 + 2 = 4$$

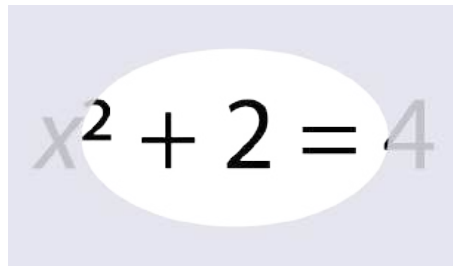

$$x^2 + 2 = 4$$

In the equation on the left, it is easy to get an overview of the whole equation, but the font may be too small. The equation on the right is more legible, but it may be hard to get an overview.

To make it easier for low-vision learners, print the superscripted terms (such as  $x^2$ ) in bold, highlight them, or use a marker or pencil to colour them. That helps the student to recognize these elements. You can also advise students to do that themselves. This also forces them to think about the structure of the equation.

$$x^2 - 3x = -5x^2 + 9x$$

$$\mathbf{x^2} - 3x = -\mathbf{5x^2} + 9x$$

$$\mathbf{x^2} - 3x = -\mathbf{5x^2} + 9x$$

$$x^2 - 3x = -5x^2 + 9x$$

Highlight the superscripted terms in some way to make them easier for low-vision learners to see. This can be useful for sighted students too.

### Brackets

Brackets can also be hard to see, especially if they are nested inside each other. You can colour them, make them bigger, print them in bold, or use a combination of these methods. Apply strict rules for colouring. For example: always colour the inner pair of brackets red.

$$2(6 - 3(4 + 5))$$

$$2(6 - 3(4 + 5))$$

$$2(6 - 3(4 + 5))$$

$$2(6 - 3(4 + 5))$$

### 3.2.2

#### Algebra tiles





**Useful for: Blind, Low vision, Sighted**

Algebra tiles are coloured squares or rectangles that are used to represent algebraic expressions and solve equations. You can buy algebra tiles (which are magnetic so they stick to a metal board) or make your own from card. In standard algebra tiles, the side that represents a positive number is yellow, green or blue; the other side is coloured red to represent a negative number.

You can easily model algebraic expressions and equations with algebra tiles. This helps students to calculate the value of an expression or solve an equation. If they understand this when using tiles, they can use similar strategies in braille or in writing letters and numbers.

To make tiles tactile for blind learners, use different textures on the two sides of the tiles. Make tactile lines on the baseboard with wikki stix or a spur wheel, and write the equation in both print and braille. If the tiles are not magnetic, use a tray to prevent the learner from brushing them off the desk.

#### Tiles

	1 (unit tile) 1 × 1 cm Represents 1 unit
	x (x tile) 1 × 3.5 cm Represents x (an unknown)
	x <sup>2</sup> (x <sup>2</sup> tile) 3.5 cm × 3.5 cm Represents x <sup>2</sup>
	Negative tiles The reverse of each tile is red. These tiles represent -1, -x, and -x <sup>2</sup>

**Zero pairs**

A zero pair is a negative and a positive tile, which together sum to make zero.

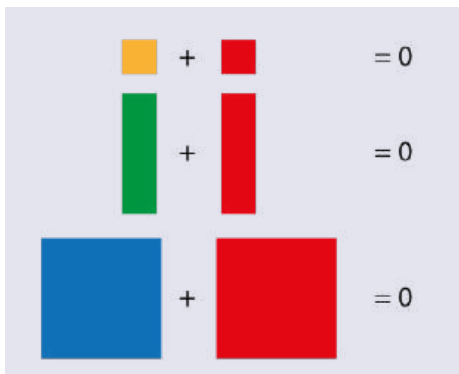
**Model algebraic expressions**

By combining different algebra tiles, you can model any basic algebraic expression.

For example:

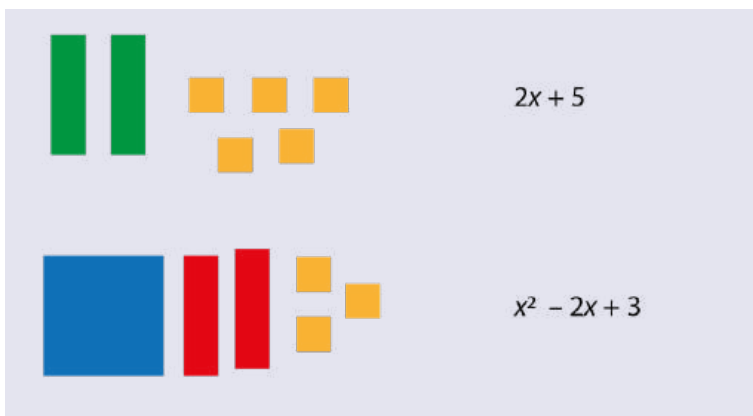
**Signed number operations**

We first start with numerical expressions. Because we don't use variables, we are working only with single unit tiles.

Example:  $3 + (-4)$

Place 3 positive unit tiles on a tray to represent the positive 3. Then add 4 negative unit tiles to represent  $-4$ .



Pair off 3 of the red tiles with 3 orange tiles, and remove them all. This leaves you with 1 red negative tile.



Hence, the value of the calculation is  $-1$ .



Example  $3 - (-4)$

Place 3 positive unit tiles on the tray.

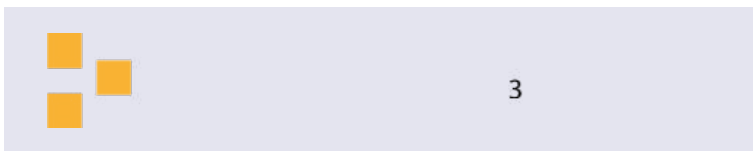

To subtract negative tiles, you want to remove red tiles. But you don't have any red tiles to work with on the tray. However, there is a way of adding red tiles to the board without changing the value of the total: for every red tile, add an orange tile.

So, add 4 red tiles and 4 orange tiles to the tray. The total value on the board is still 3.

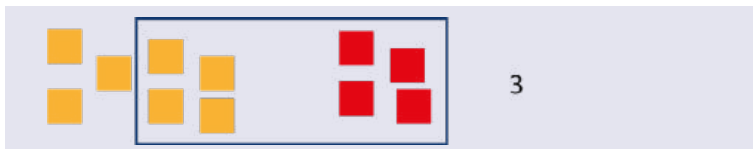

Now take away 4 red tiles. This leaves you with 7 orange tiles. Hence,  $3 - (-4) = 7$

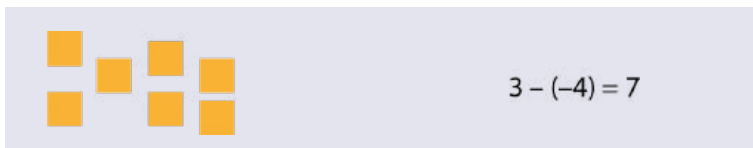

### Multiplication

Make a group of 2 orange tiles and replicate it 3 times. Count the tiles. The answer is 6.

Example:  $2 * 3$



Example:  $-2 * 3$



If the factor is negative, you can just flip over the tiles. The answer is -6.

### Division

Example:  $-8 / -4$

First place 8 negative unit tiles on the tray.



Divide them into 4 equal groups.



Each group has 2 negative tiles. Because the divisor is negative, you need to flip over the tiles. Count the number of groups. The answer is 2



## One-step algebraic equations

Example:  $3x = 6$

Draw a horizontal line on a sheet of paper, and then a vertical line below that, dividing the sheet into three parts. Write the equation above the horizontal line. Use the tiles to model the equation on each side.

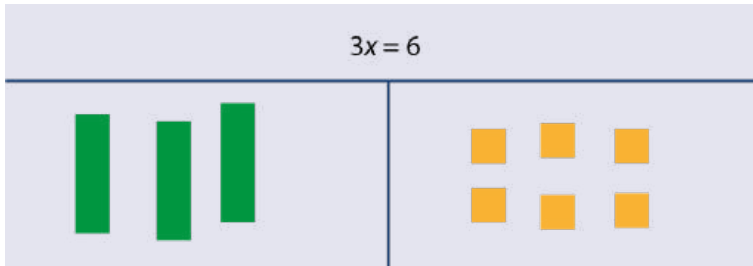

To solve the equation, you need to get the  $x$  tile on its own. Divide the  $x$  tiles into three equal groups of one  $x$  each. What you do on one side of the equation, you must also do on the other side. So divide the unit tiles into three equal groups (right side of the diagram).

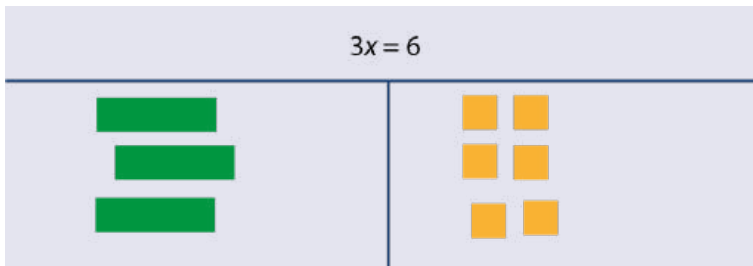

Remove two of the  $x$  tiles from the left side and 2 from the right side. You can now see that each individual  $x$  is equivalent to a group of 2 unit tiles. In other words,  $x = 2$ .

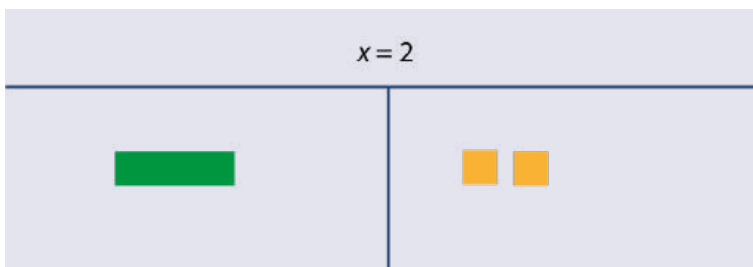

At the end of this calculation, the assistant teacher or a classmate can make a photo with their mobile phone to send to the maths teacher.

## Multi-step equations

Example:  $2x - 3 = -5$

First model the equation (see the diagram below).

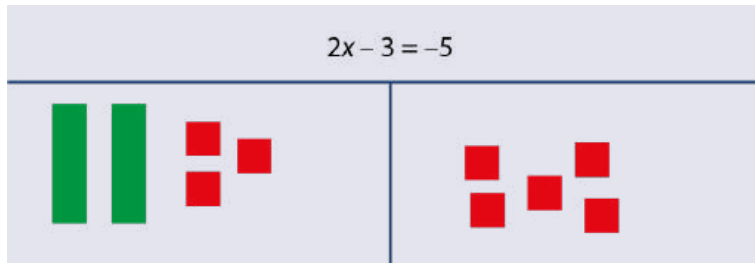

We want to eliminate the 3 negative tiles. We can do that by adding 3 positive tiles to each side.

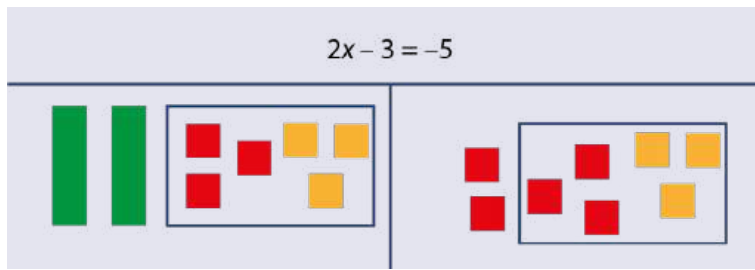

The 3 positive and negative units cancel each other out, so we can remove them. This leaves us with 2 negative units.

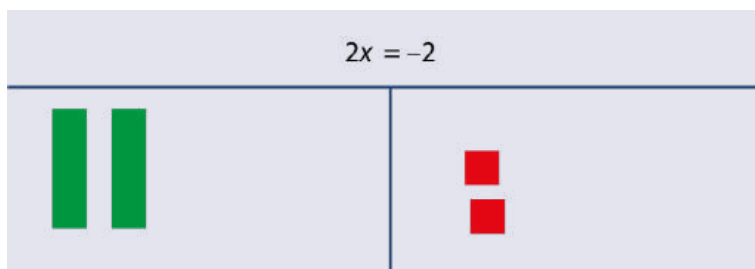

We then divide the  $x$ s into groups, and do the same with the tiles on the right side. This shows that  $x = -1$ .

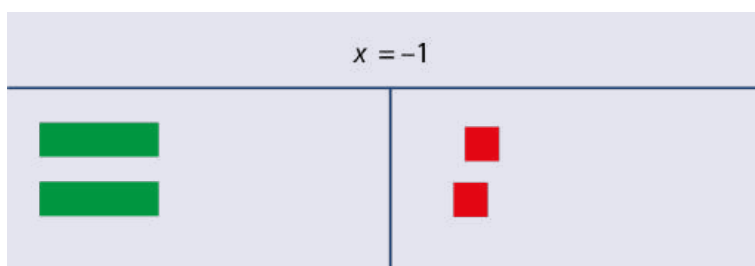



Evaluating expressions

Example:  $x^2 - 3x + 4$  for  $x = 2$

First model the expression.

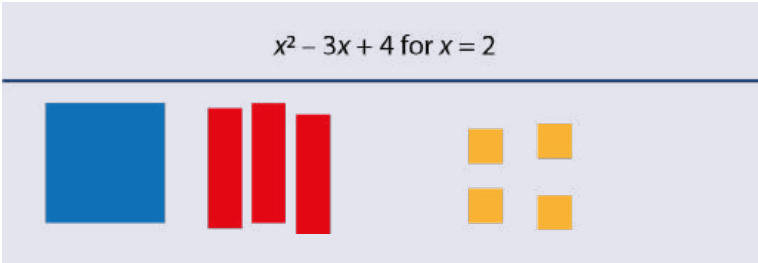

We know that  $x = 2$ . We can replace each positive  $x$  tile with 2 positive unit tiles. In this equation, the  $x$ 's are negative, so we can replace each one with 2 negative unit tiles. That makes 6 negative units in all.

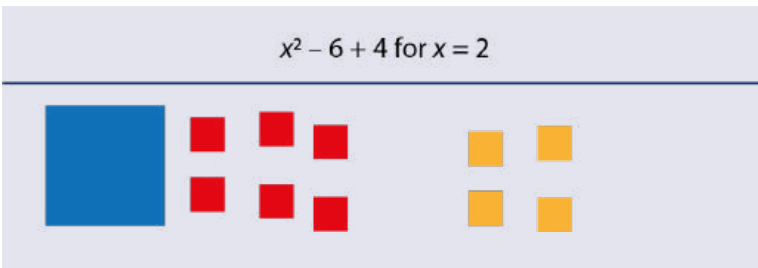

That brings us to the  $x^2$  tile. Build a square of orange tiles with sides of  $x = 2$ .

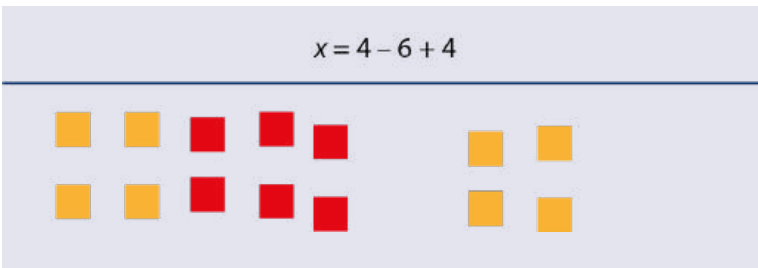

Then we have to find the combined value of all these tiles. Start with pairing up the negative and positive tiles.

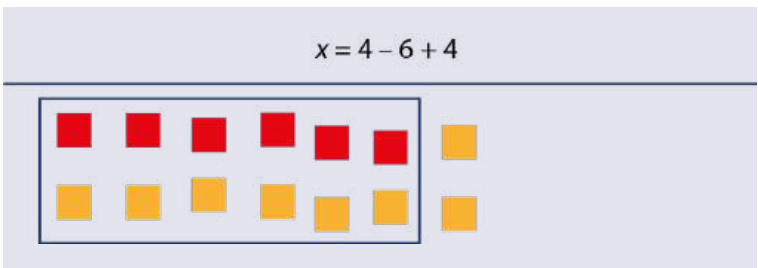

Remove all the tiles you have paired off. That leaves 2 orange tiles left over. The answer is  $x = 2$ .

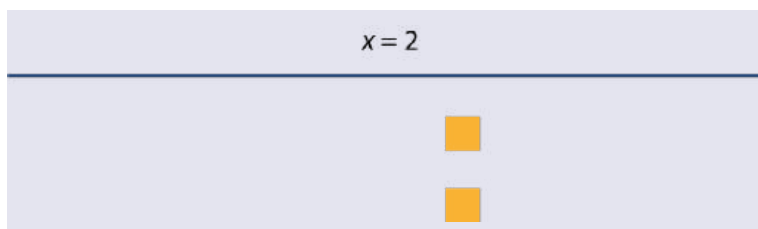

**Combining like terms**

Suppose we want to add two polynomials:

Example:  $2x^2 + 3x - 6$   
 $+$   
 $-x^2 + 2x + 4$

First model the expression with tiles.

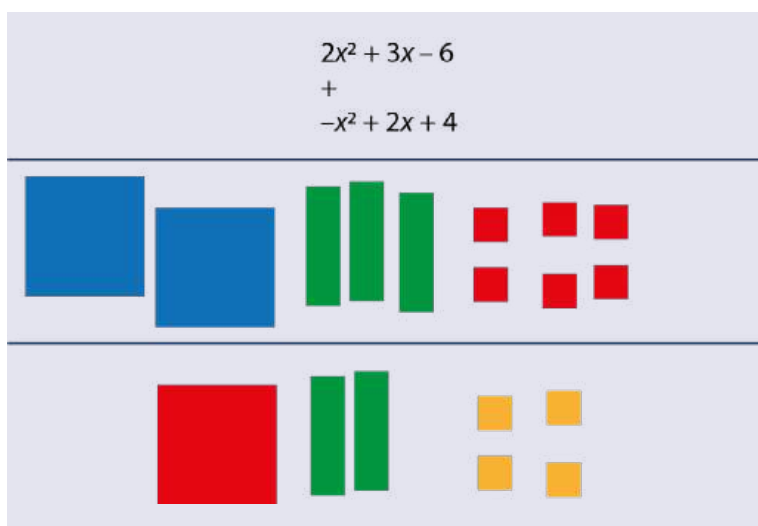

Combine the same type of tiles.

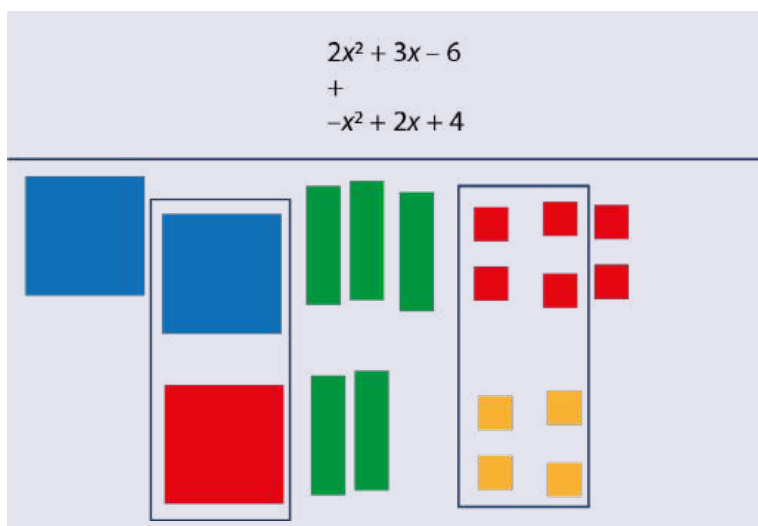

Pair off and remove any positive and negative tiles. The final answer is  $x^2 + 5x - 2$ .

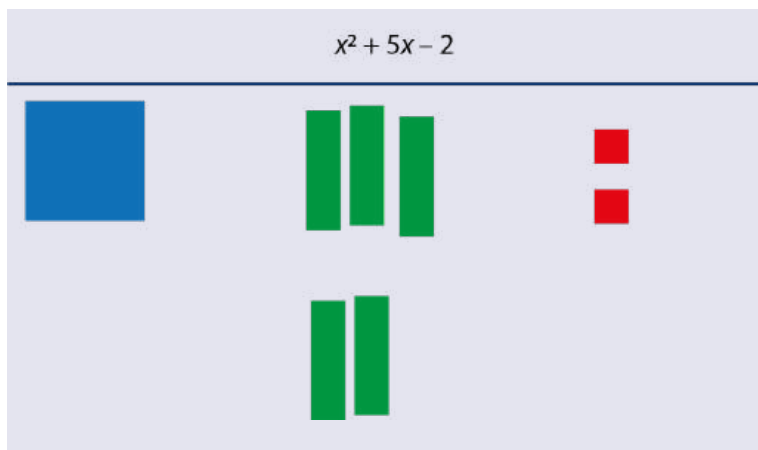

### Subtracting

Here we want to subtract two polynomials.

Example:

$$\begin{array}{r} 2x^2 + 3x - 6 \\ - \\ -x^2 + 2x + 4 \end{array}$$

First we model the expressions with tiles.

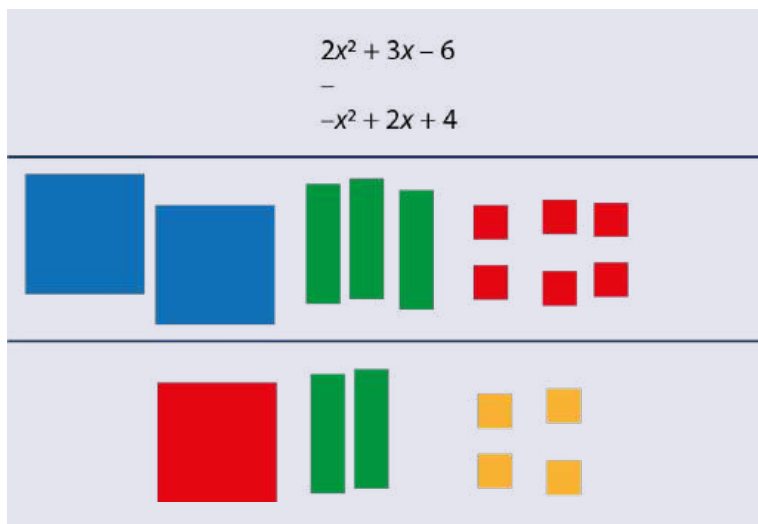

Because the expression involves subtraction, we turn over every tile in the second polynomial to change their signs.

$$\begin{array}{r} 2x^2 + 3x - 6 \\ - \\ -x^2 + 2x + 4 \end{array}$$

We can then combine the two polynomials.

$$\begin{array}{r} 2x^2 + 3x - 6 \\ - \\ -x^2 + 2x + 4 \end{array}$$

We then pair off the positive and negative tiles to get the final answer:  $3x^2 + x - 10$

$$3x^2 + x - 10$$

## Multiplying binomials

Example:  $(x + 3)(x + 1)$

To multiply terms, we make two lines with wax sticks crossing each other: one horizontal and one vertical. We put the first term to the left of the vertical line, and the second term above the horizontal line.

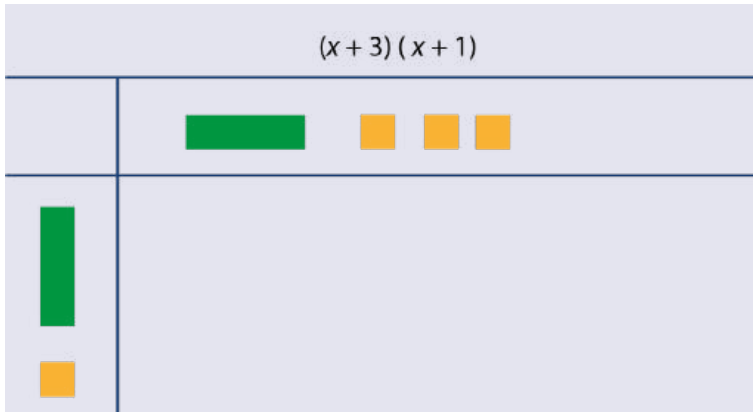

Starting with the first tile above the horizontal line, multiply it with each tile to the left of the vertical line. Add the equivalent tiles in the bottom right quadrant.

So for our example,  $x$  times  $x$  equals  $x^2$ ; and  $3$  times  $1$  equals  $3x$ .

Do the same for the other tiles above the horizontal line.

In our example,  $1$  times  $x$  equals  $x$ , and  $1$  times  $3$  equals  $3$ .

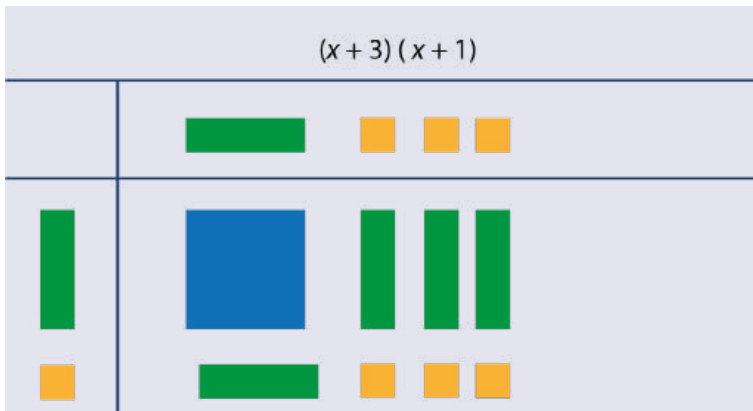

Reorder the items in the bottom-right quadrant. The final answer is  $x^2 + 4x + 3$

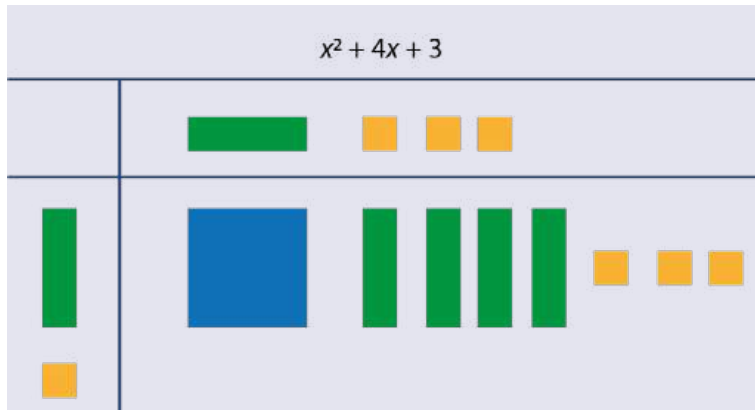

### 3.2.3

#### Braille

As with many areas of mathematics, blind learners will have to use braille to progress beyond a certain level in algebra. This is similar to sighted learners, who can also progress only so far without learning algebra notation.

Introduce braille notation early on in the teaching process, at the same time as sighted students learn algebra notation. Students will need to be familiar with how to write equations in braille, especially in the use of brackets and signs for superscripts and roots. See **Part 2: Braille** for more.

#### More information

APH Tactile graphic image library. Algebra. (Requires free registration; uses Nemeth notation)

<https://imagelibrary.aph.org/portals/aphb/#category/83>

Mathsbot. Algebra tiles. <https://mathsbot.com/manipulatives/tiles>

Idaho STEM Action Center. A beginner's guide to teaching with algebra tiles.

<https://www.youtube.com/watch?v=AN4MGUP4VXQ>

Willings, C. Teaching students with visual impairments : Algebra.

<https://www.teachingvisuallyimpaired.com/algebra.html>

## 3.3

### Drawing

Useful for: Blind, Low vision

Drawing is more complicated for blind and visually impaired students than for sighted students, especially if they have to draw a line that connects two specific points. The problem is that most blind and visually impaired students can observe only two points at a time using their fingertips. They lack an overview: students with low vision may have to bring their eyes very close to the paper, while blind students have to observe the drawing tactilely.

Students can use the following tools to draw lines (see also **Part 2: Drawings and graphs**):

- Pinboard
- 2 pushpins
- Ruler
- Foldable parallelogram.

### 3.3.1

#### Parallel lines

**Step by step for students with low vision**

**Useful for: Low vision**

In the picture you see a line  $L$  and a point  $P$ . Draw a line that is parallel to  $L$  and goes through  $P$ .

**Step 1.** Place two pushpins in line  $L$ . It does not matter where, but the drawing will be more accurate if they are far apart.

Place the foldable parallelogram with a long side against the pushpins.



**Step 2.** Fold the parallelogram so that the other long side is against point  $P$ . It does not matter if the inner or outer side of the parallelogram touches point  $P$ .



**Step 3.** Draw a line through point P.

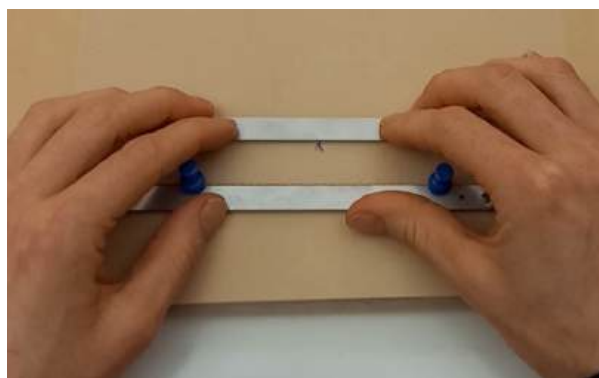
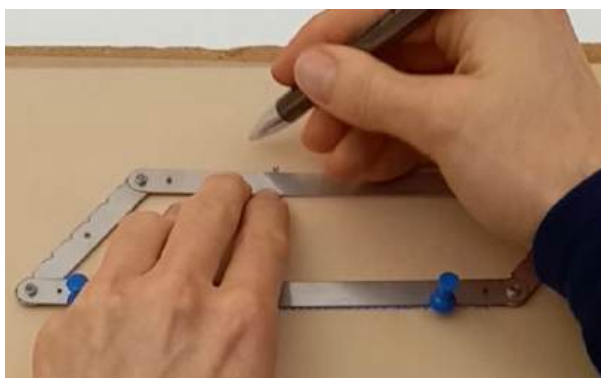
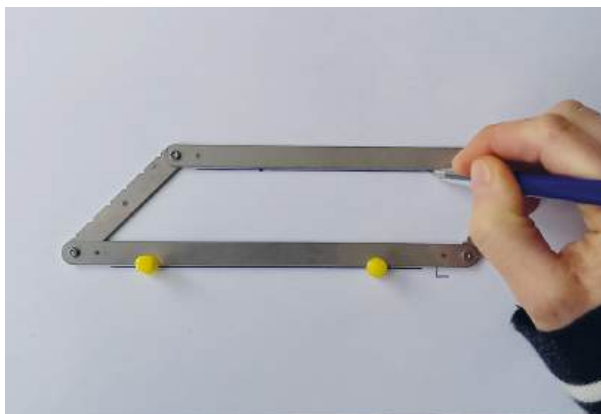

If P and L are far apart (left), place the outside edges of the parallelogram against L and P.

If P and L are close to each other (right), place the inside edges against L and P.



**Step by step for blind students**

**Useful for: Blind**

The following pictures show the same steps on drawing foil (for blind students). Blind students follow the same steps as students with vision. They need drawing foil and a rubber mat, which they place on top of their pinboard. Do not forget the pinboard: it prevents the table from being damaged by the pushpins.

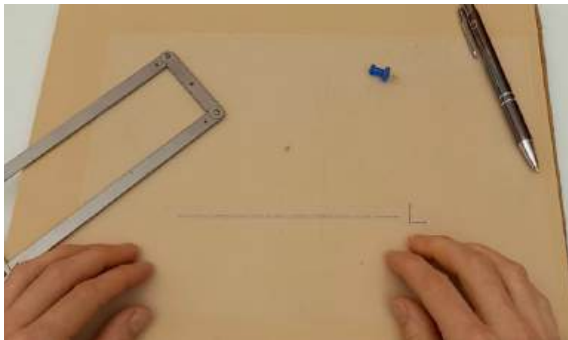

1

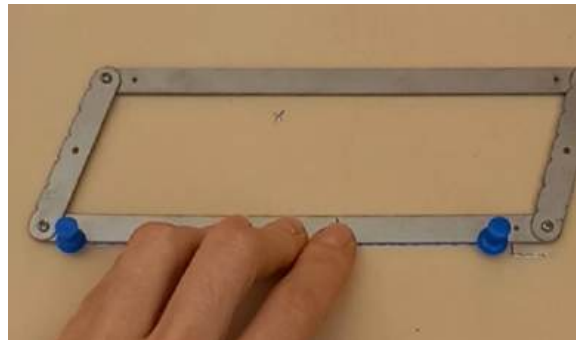

2



3

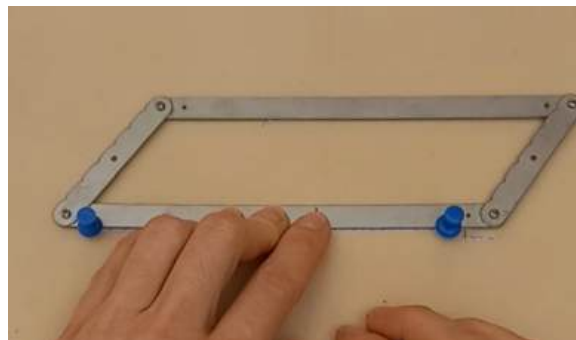

4

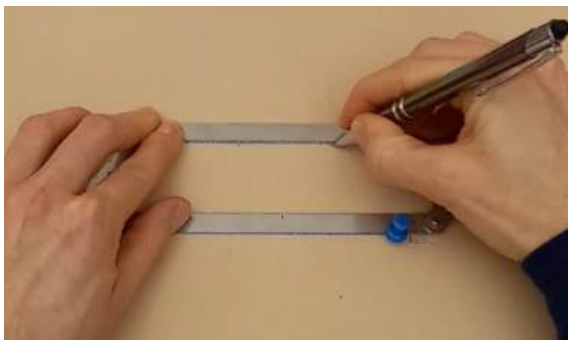

5

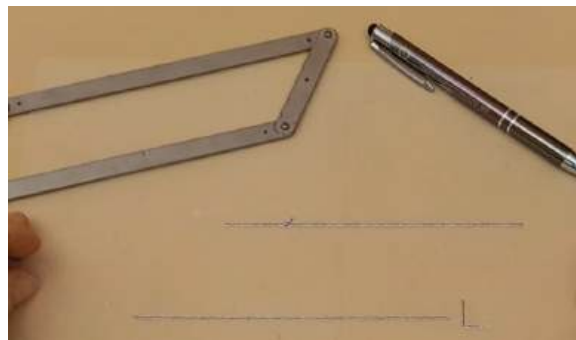

6

Steps in drawing parallel lines for blind students.

### 3.3.2

#### Shadows

The following steps help students to construct which part of a surface is covered in shadow.

#### Step by step for students with low vision

##### Useful for: Low vision

On the left of the picture is a lamp post. The light is on top. To the right of it stands a parked truck. Where on the ground does the truck cast a shadow?

**Step 1.** Place a pushpin in the light source and another pushpin on the top right of the object that blocks the light (in this case it is a truck).

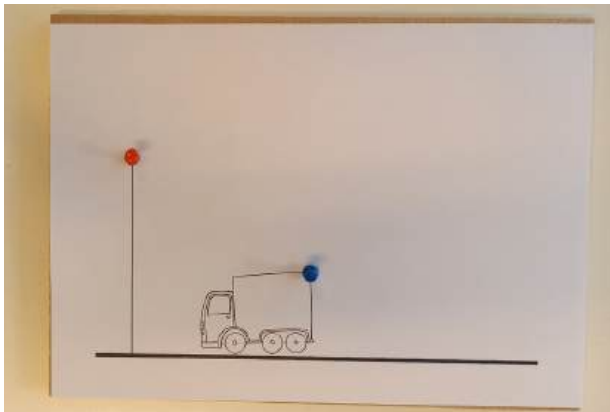

**Step 2.** Place the ruler against the pushpins and draw a line along the ruler. The line is split into two segments. Start at the light source and draw the line towards the second pushpin. Continue the line after the pushpin and draw the line to the ground.

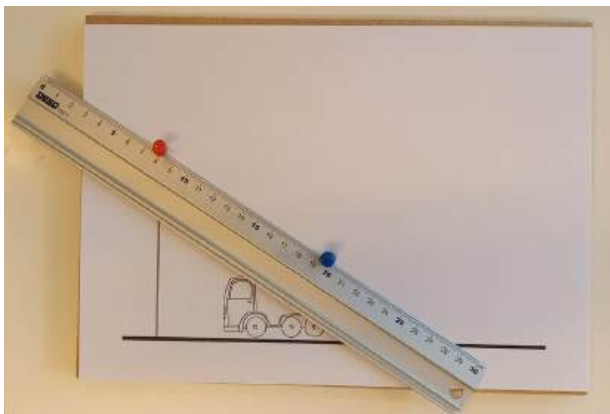

**Step 3.** Leave the pushpin at the light source in place. Move the other pushpin to the other side of the truck.

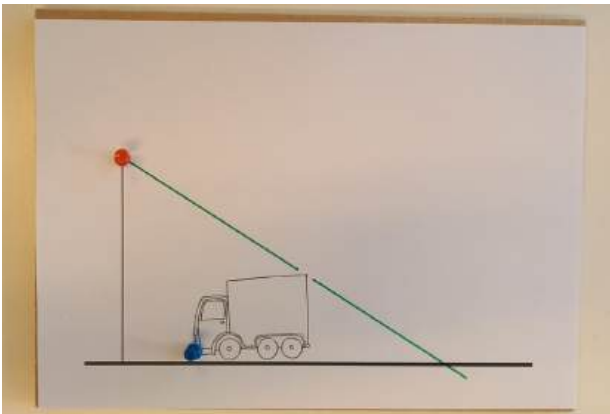

**Step 4.** Place the ruler against the pushpins and draw a line along the ruler. Remember that the second pushpin splits the line in two segments, and that you have to continue the line after the pushpin.

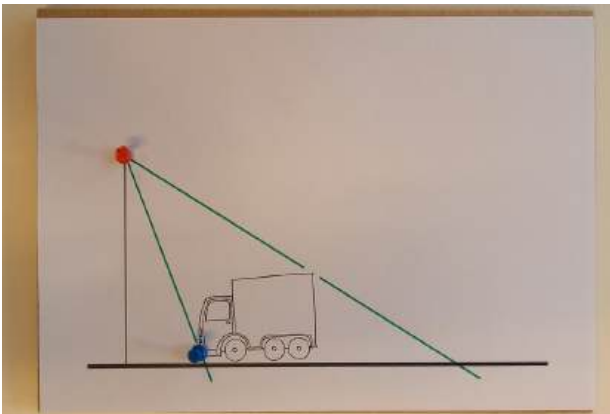

**Step 5.** Mark the area that is covered in shadow.

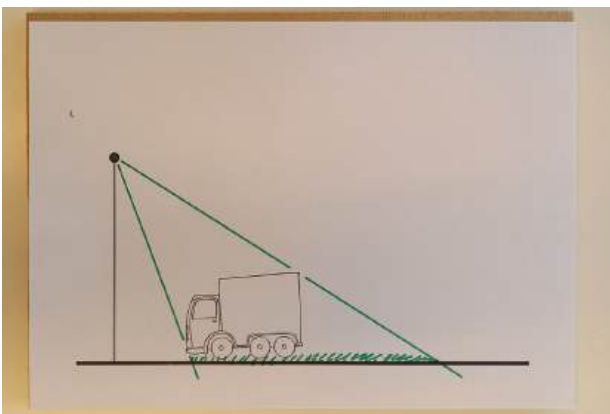

**Step by step for blind students**

**Useful for: Blind**

The following pictures show the same steps on drawing foil for blind students. Blind students follow the same steps as students with vision. They need drawing foil and a rubber mat, which they place on top of their pinboard.

It is hard for blind students to find the correct position of the pushpin on the object that blocks the light, so make sure to start with simply shaped objects, such as a box or a table.

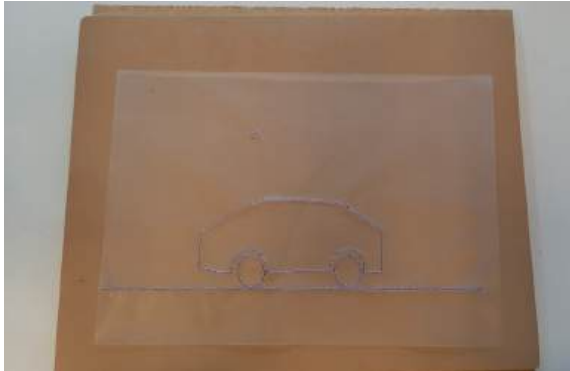

1

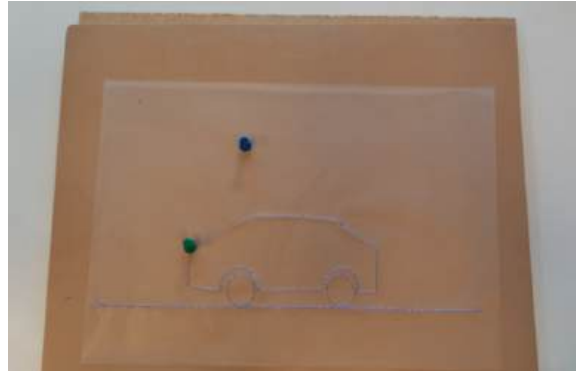

2

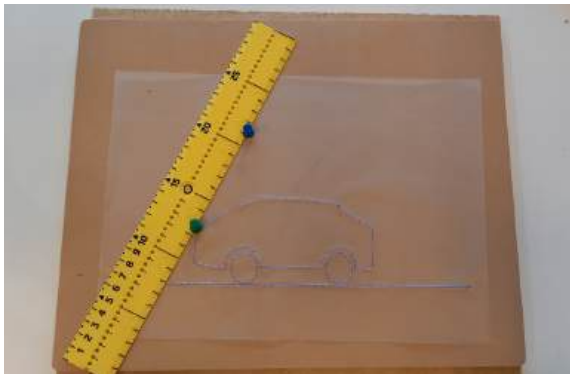

3

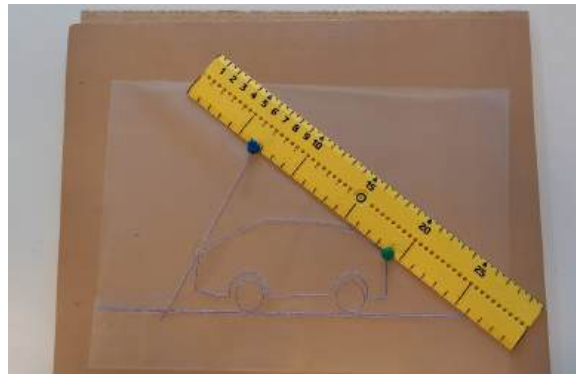

4

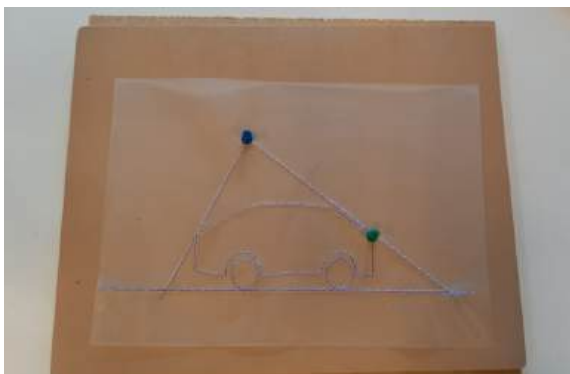

5



6

Steps in drawing shadows for blind learners.

Shadow: Drawings to copy

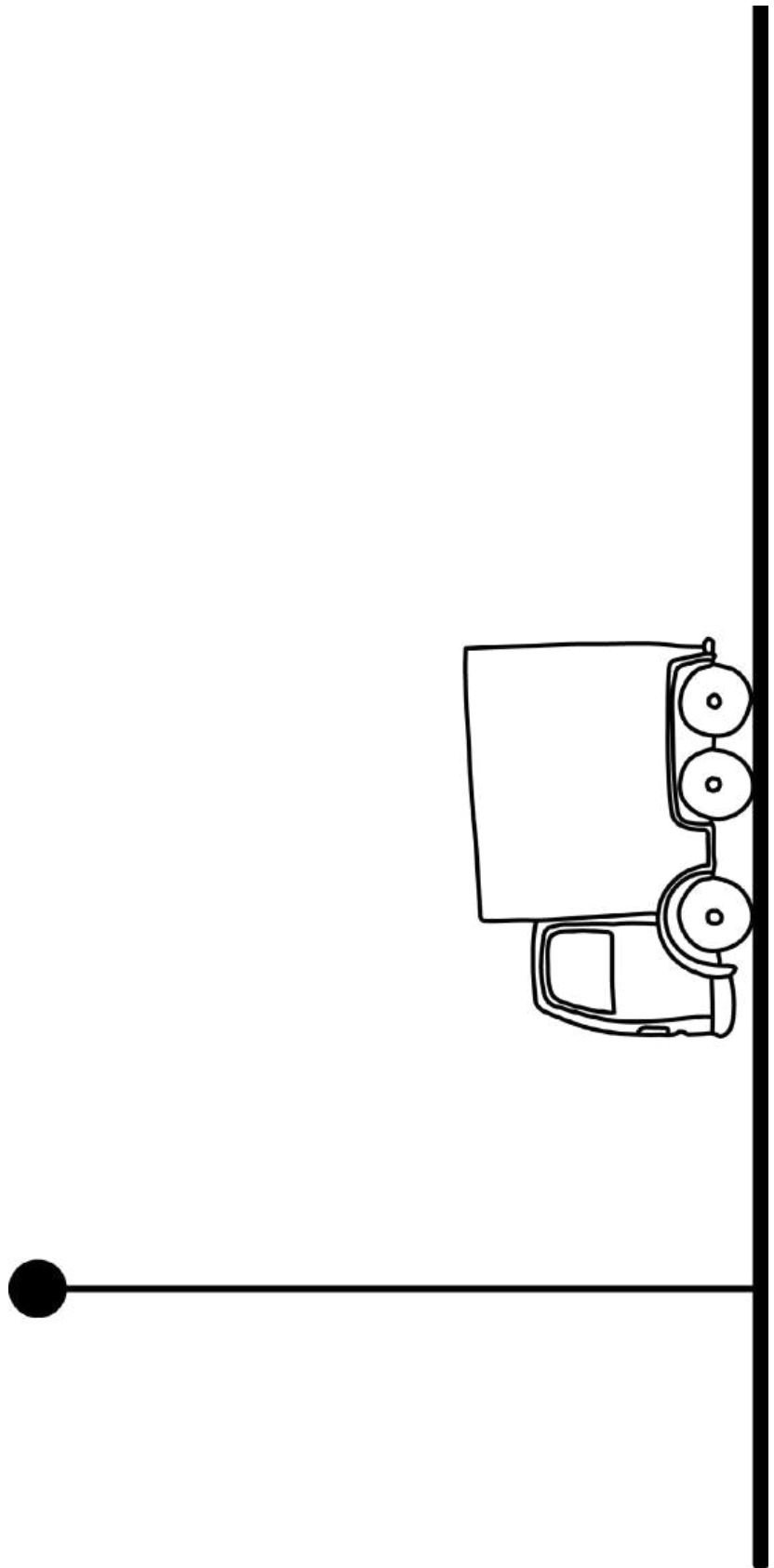

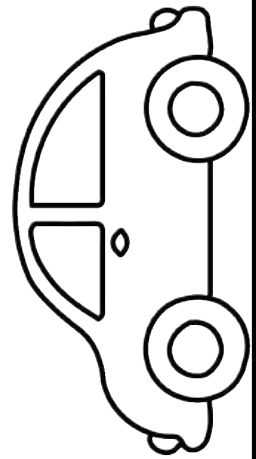

**3.3.3**

**Line of sight**

**Useful for: Blind, Low vision**

Lines of sight show which objects a person can (and cannot) see if an object is in the way.

You see a room with a window in it. This is the square with a gap in the right side. The gap is the window. In the room is a woman. Her eye is depicted with a dot. She is called the observer. Outside the room are six stars. Draw the sight lines and encircle the stars the woman can see.

**Step 1.** Place a pushpin in the eye of the observer (the woman). Put the other pushpin at the edge of the object that blocks the sight (the edge of the wall).

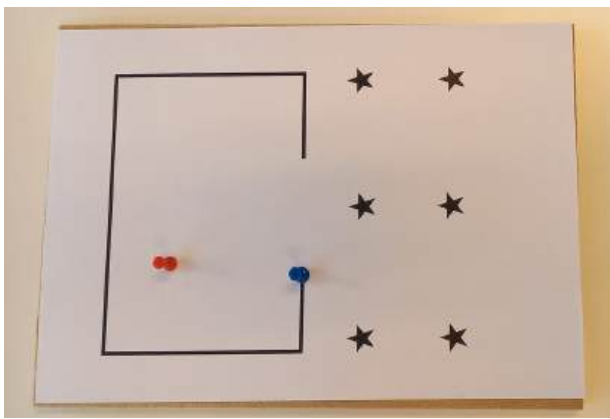

**Step 2.** Place the ruler along the pushpins and draw a line along the ruler. The line is split into two segments. Start at the observer and draw the line towards the other pushpin. Continue the line after the pushpin to the end of the paper.

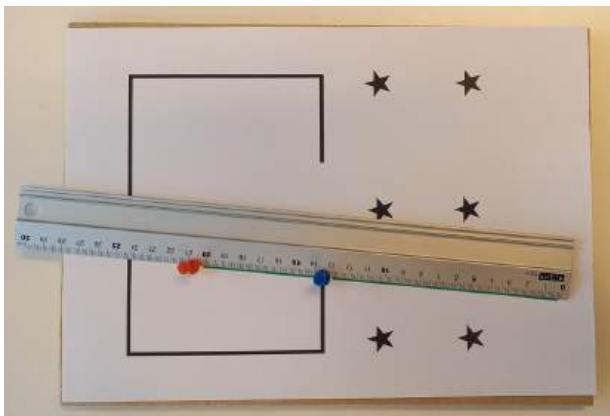

**Step 3.** Leave the pushpin at the observer in place. Move the other pushpin to the other side of the window.

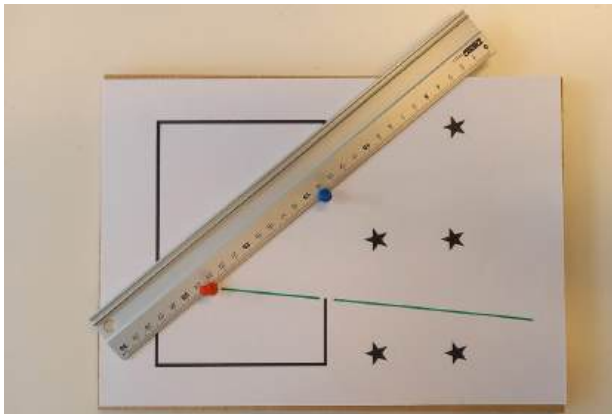

**Step 4.** Place the ruler against the pushpins and draw a line along the ruler. Remember that the second pushpin splits the line in two parts and that you have to continue the line after the pushpin.

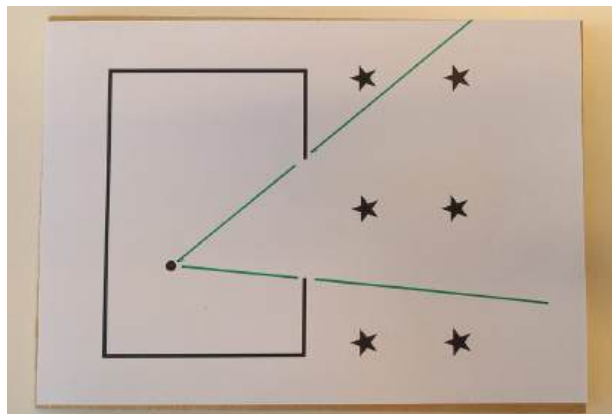

**Step 5.** Circle the stars that the observer can see.

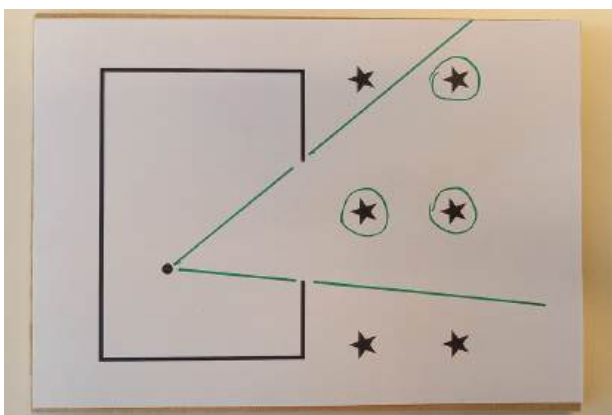



Line of sight: drawing to copy

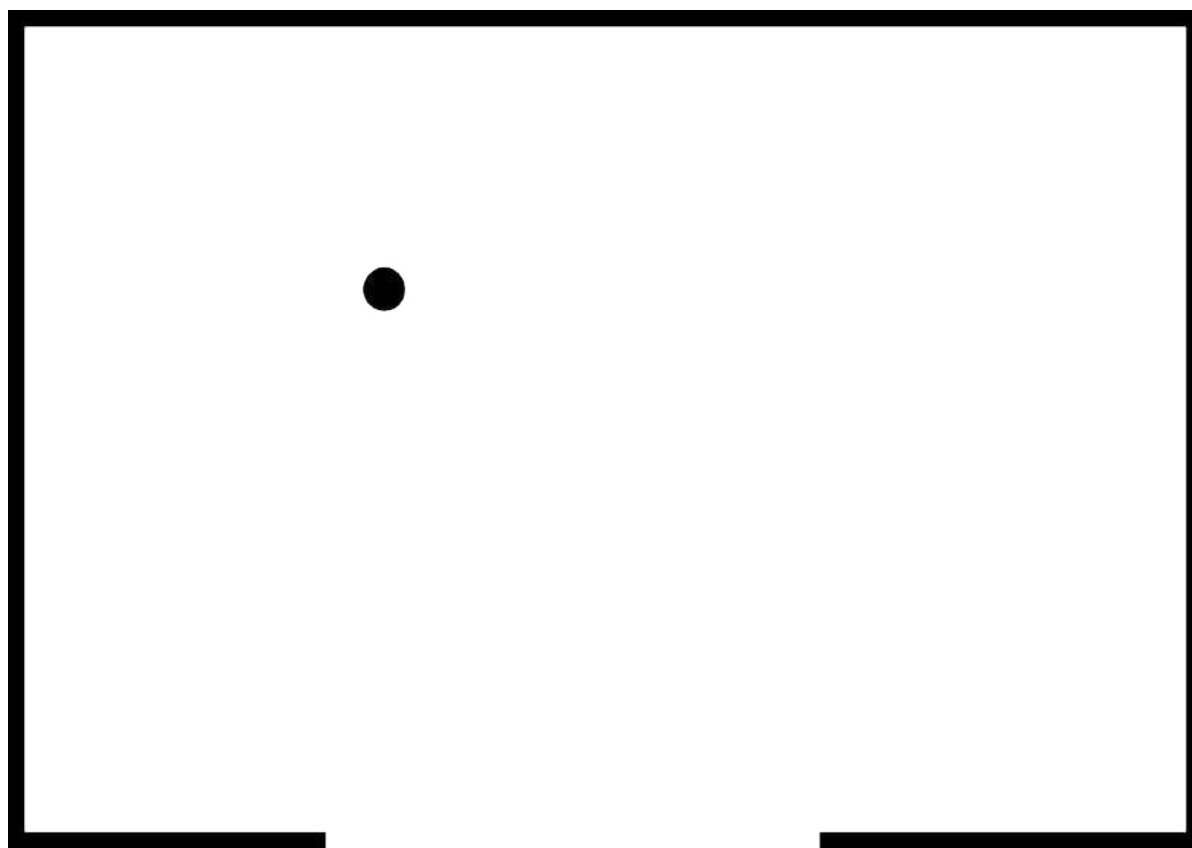

## 3.4 Plane geometry

Geometry is a very visual subject. Students must learn how to measure lengths, calculate areas and perimeters, and recognize shapes. Blind and visually impaired students will need adapted tools, instruction, and exercises to do this.

See **Part 2: Drawings and graphs** for techniques for drawing, and **Measurement and drawing tools** for measuring lines and shapes.

This chapter describes how to adapt exercises for visually impaired and blind learners.

### 3.4.1 Understanding diagrams Useful for: Blind

**Working with figures.** Learners encounter many geometry exercises in which they must read the information from an image. Blind students need adaptations to those exercises: they need tactile figures and a description.

There are three options to do this (below are examples of these options):

- **Tactile figure with labels + instructions in braille.** The tactile figure includes labels in braille on the figure, plus instructions (also in braille).
- **Description only.** No figure: the text in braille describes it instead.
- **Tactile figure + description.** A tactile figure gives the student an insight into the shape. The numbers are contained in the description (in braille).

The last option (tactile figure + description) is preferred, for two reasons:

- Most blind students prefer to find the numbers in a text instead of an image. Blind students might miss information in a drawing: if they do not go there with their fingertips, they don't know it exists. If the numbers are incorporated in the description, they can't miss them, and they can find them again easily if necessary.
- The tactile figure helps blind students to visualize the problem.

The more complicated the figure, the more important it is to provide tactile figures.

Example

Original exercise for sighted learners

Calculate the area of the figure below.

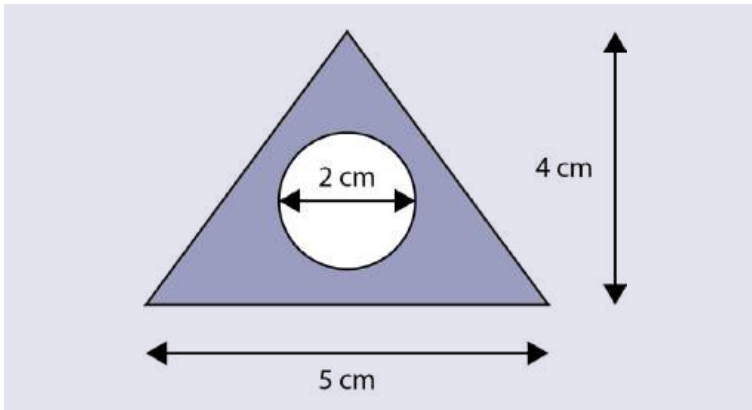

Calculate the area of the figure.

Adapted exercise: tactile figure with labels + instructions in braille

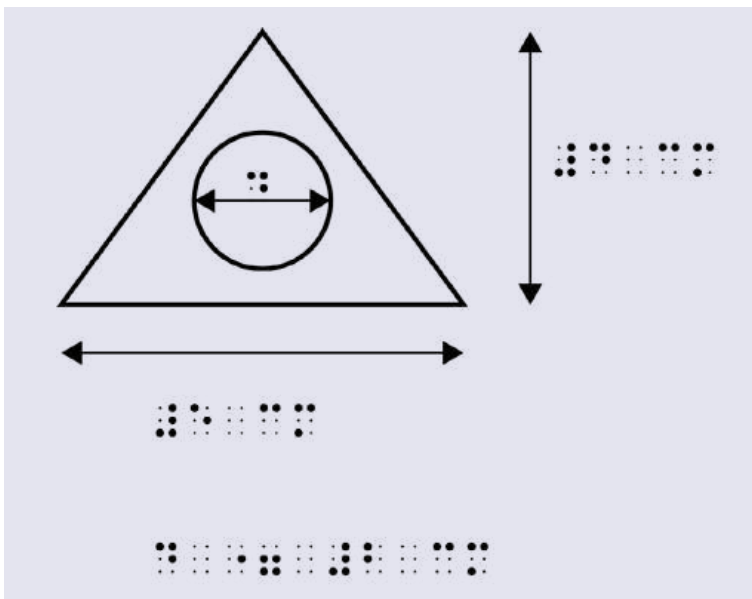

The braille gives the length of the distances in centimetres. There is not enough room inside the circle for the braille, so only the letter "d" is put in the circle. The text below the figure reads "d = 2 cm".

Note: The student may miss information written next to the drawing. It would be better to include the numbers in the description.

**Adapted exercise: description only (in braille)**

A triangle has a base of 5 cm and a height of 4 cm. In its centre is a hole with a diameter of 2 cm. Calculate the area of this figure.

Note: student may have difficulty to visualise the exercise.

**Adapted exercise: tactile figure + description in braille**

Calculate the area of the figure: a triangle with a base of 5 cm and a height of 4 cm. In its centre is a hole with a diameter of 2 cm.

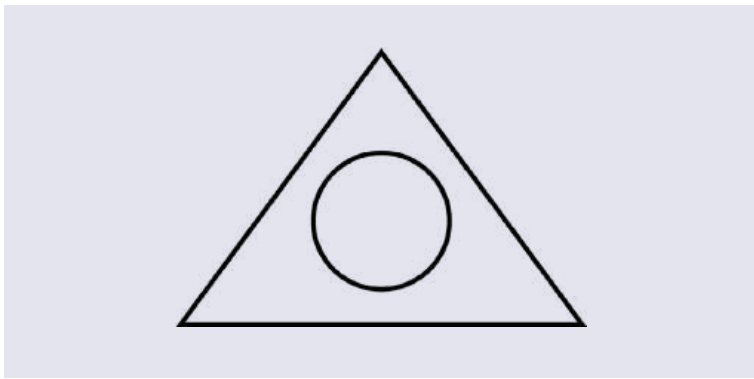

This is the preferred option. The learner can find the information needed to solve the problem easily. The figure is simple and easy to understand tactilely.

**Verbal support and written descriptions**

Blind students lack the overview that well sighted students have. They may have difficulty recognizing shapes, especially if the figure contains a lot of details. If this is the case, tell the student to follow the perimeter of the shape with their index finger.

Students may also overlook text, numbers, symbols and “obvious” properties of a figure, such as the fact that lines are parallel, perpendicular, or equidistant.

You can give verbal support to help blind students understand figures. In a test or exam, include a description of a figure along with the problem.

For the diagram below, verbal support could be like the following. As you give each part of the description, make sure the student is feeling the relevant part with their fingers.

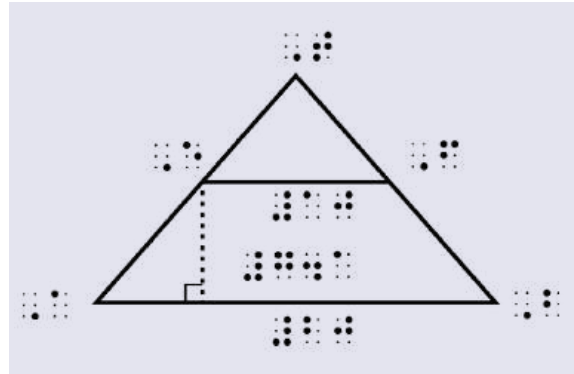
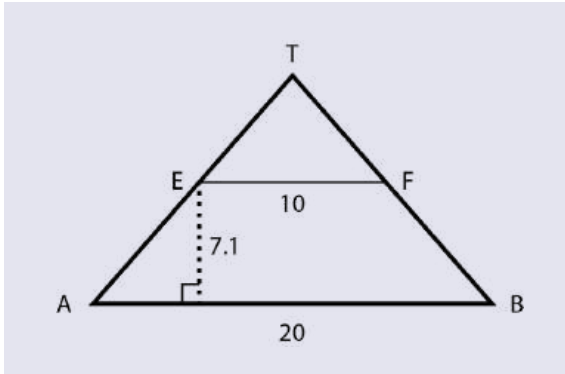

#### Big picture

- You see a triangle standing on the ground. → shape
- The lower left corner is called A, the lower right corner is B. The top is T → text
- Within the triangle is a horizontal line, parallel to AB → property
- The left end of the line is E, and the right end is F → text
- Below point E is a dotted, vertical line, that ends at AB → property
- At the lower left end of the dotted line is a square → symbol
- This square indicates that the dotted line and AB are perpendicular → property

#### Details

- The length of the base of the triangle, between A and B, is 20 centimetres → numbers
- The length of the horizontal line between E and F is 10 centimetres → number
- The length of the vertical line from E to the base of the triangle is 7.1 cm → numbers

### 3.4.2 Length

#### Useful for: Blind, Low vision

Students can measure lengths using an adapted ruler (see **Part 2: Measurement and drawing tools**).

**Working with figures.** For simple tactile diagrams, blind students can use an adapted ruler to measure lengths. Strip the diagram of details, and do not place it in a grid.

**Adapted exercises.** The accuracy of the measurement depends on the ruler and the skills of the student. In tests, accept an inaccuracy of at least 0.5 centimetres.

If the value of the measurement is necessary for further calculations, consider just giving the value rather than requiring the student to measure it.

### 3.4.3

#### Perimeter and area

Useful for: Blind, Low vision

Students usually first learn to find an area or perimeter by counting squares before they learn to calculate it using a formula.

#### Perimeter and area: by counting

When you introduce students to the concept of area, they will usually work with a simple geometrical shape in a grid. They count squares to find the area, or count the number of units along the edge of the object to find its perimeter.

**Working with figures.** Blind and visually impaired students need a figure in a tactile grid where it is easy to distinguish the grid from the perimeter. The pictures below show examples of such figures. You can make such figures using any of the techniques described in **Part 2: Drawings and graphs.**

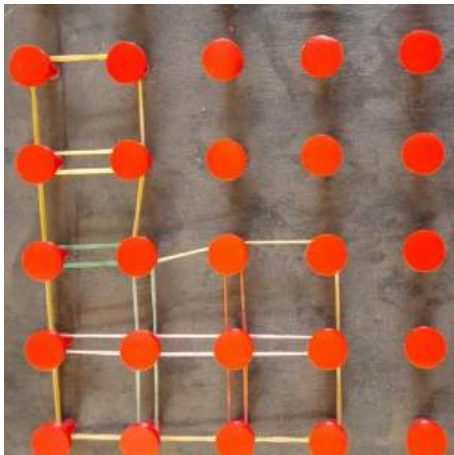

A shape made on a geoboard. The perimeter is marked by single rubber bands. Grid lines inside the figure are marked with double rubber bands. Grid lines outside the figure are absent.

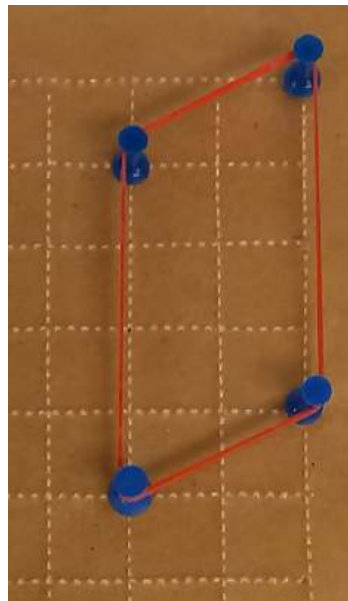
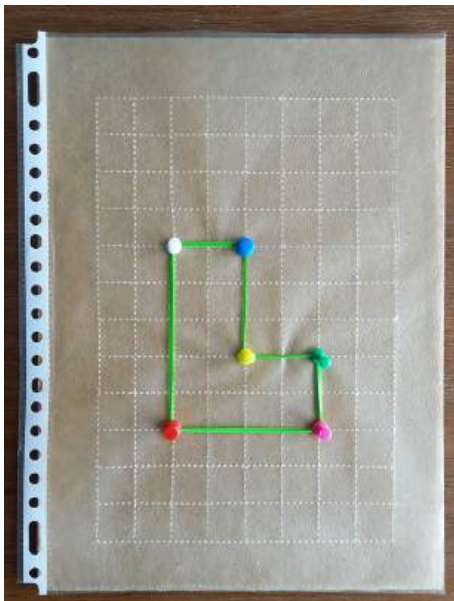

Figures made using a grid made from a plastic file pocket, in combination with pins and a rubber band. All grid lines are made with a tracing wheel. The perimeter is marked by rubber bands. The perimeter could also be made with double lines, dotted lines, etc.

In the two lower examples, the student can wrap a piece of string around the pushpins and then measure the length of the string with a ruler.

The example on the right is not suitable for counting the perimeter because two of its sides are not along grid lines. For teaching the concept of a perimeter, it is best to start with a square or a rectangle. For introducing the concept of area, it is better to start with an example that contains only full squares (not halves, as in the figure on the right).

### Verbal support

Blind students need very explicit instructions on how to “count” to learn the difference between perimeter and area. A structured approach is helpful.

**Before you start.** The student needs an overview of the figure. Ask them to explore the figure and name the shape (rectangle, square) or describe it (an L-shape).

**Perimeter.** As you give each instruction, make sure the student is feeling the relevant part with their fingers.

You’re going to count the perimeter of this square. You use the grid for this. The distance between two pins is one centimetre.  
 Move your fingertip alongside the perimeter in a clockwise direction. Start with your fingertip at the upper left corner.  
 As you follow the perimeter, you can feel the lines of the grid. Move your fingertip from pin to pin along the grid lines and count the number of units.

**Area.** As you give each instruction, make sure the student is feeling the relevant part with their fingers.

You’re going to count the area of this rectangle. You use the grid for this. Every square of the grid inside this figure is one square centimetre.  
 Count the squares of the grid from left to right. Start with your left index finger in the square in the upper left corner and keep your left index finger there to mark your starting point.  
 Move your right index finger to the right: one square at a time. Count the number of grid squares that are inside the figure.  
 If this upper row is done, move your left index finger one row down. Use your right index finger to count the number of squares in this row.  
 Move your left index finger down another row and do the same until you’ve counted the full area.

**Perimeter and area: by formula**

As with sighted students, blind and visually impaired students need to first develop a concept of area before they can generalize the concept to use a formula. So spend enough time on the steps described in the counting method above. When they have understood the concepts of perimeter and area in these easy figures, they can learn the formulas for calculating perimeter and area.

**Original exercise for sighted learners**

Calculate the perimeter of the figure below.

Calculate the perimeter of the figure below.

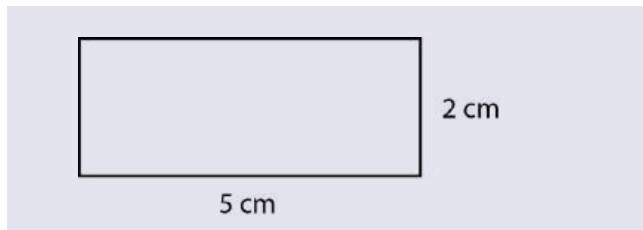

**Adapted exercise: tactile figure with labels + instructions in braille**

Calculate the perimeter of the figure below.

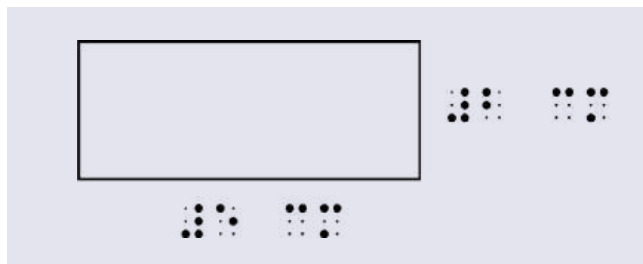

Note: The learner may fail to detect the labels giving the measurements.

**Adapted exercise: description only (in braille)**

Calculate the perimeter of a rectangle with sides 2 and 5 centimetre.

Note: This may be sufficient once the student has is familiar with the concept or a rectangle.

**Adapted exercise: tactile figure + description in braille**

Calculate the perimeter of a rectangle with sides 2 and 5 centimetre.

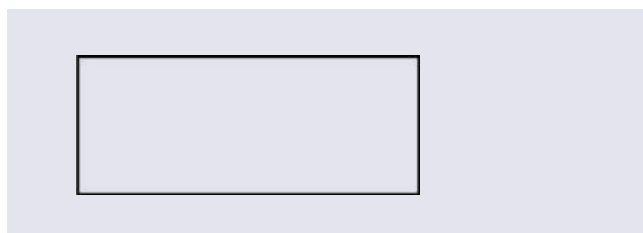

Note: this is the preferred option. The learner can find the figures required easily in the description. The tactile figure provides reinforcement about the nature of the shape.



### 3.4.4 Circles

**Useful for:** Blind, Low vision

**Drawing a circle.** See **Part 2: Drawings and graphs** for ways for blind and visually impaired students to draw circles.

**Centre of a circle.** A blind learner can find the centre of a circle in various ways. Here are two:

- **Folding.** Cut the circle out, then fold it in half once, and then again. The centre is where the folds cross.

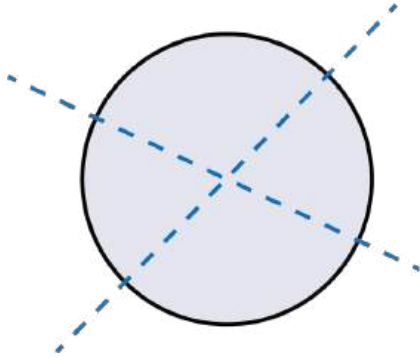

Finding the centre of a circle by folding.

- **Tangents.** Put a pushpin into the circumference of a tactile circle. Place a ruler against the pushpin and use it to draw a tangent at this point. Then use a set-square to draw a perpendicular line across the circle. Put another push-pin into a different place on the circumference, and repeat the procedure. Where the two perpendicular lines cross is the centre. Put a pushpin at this point, then check the accuracy by measuring the distance to various locations on the circumference with a tactile ruler.

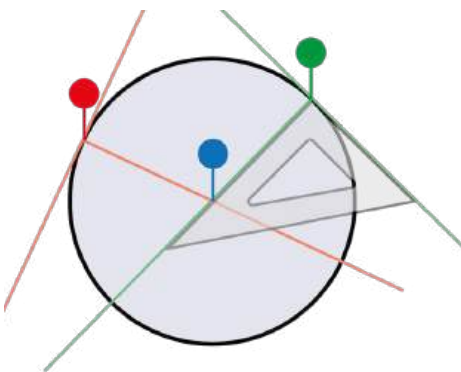

Finding the centre of a circle using pushpins and a set-square.

**Perimeter and area.** To calculate the perimeter or area of a circle, blind and visually impaired students can learn to work with the same formulas as sighted students.

**π:** In braille, the letter π can be written as ⠠⠠⠠⠠⠠⠠ (the Greek letter) or ⠠⠠⠠⠠⠠⠠ (the letters “pi”).  
For example:

a = π × r <sup>2</sup>				
a	=	pi	×	r <sup>2</sup>
⠠⠠	⠠⠠	⠠⠠⠠⠠	⠠⠠	⠠⠠⠠⠠⠠⠠
or				
⠠⠠	⠠⠠	⠠⠠⠠⠠	⠠⠠	⠠⠠⠠⠠⠠⠠

**Measuring perimeters with a string.** Blind students can measure the perimeter of a circle or cylinder with a piece of string. They will need an adapted ruler to measure the length of the string. See **Part 2: Measurement and drawing tools** for more.

### 3.4.5

#### Measuring angles

##### Useful for: Blind

Blind students can measure angles using an adapted protractor. See **Part 2: Measurement and drawing tools** for how to adapt a protractor for a blind student, and **Drawings and graphs** on how to make tactile drawings.

A protractor is always used together with a tactile figure where the student measures the angle. In drawings, make sure the lines are at least 1 cm longer than the radius of the protractor. This is necessary because blind students cannot see the lines through a transparent protractor. They depend instead on the part of the lines that extends beyond the protractor.

Blind students follow the same steps in using a protractor as with sighted students, but with some adaptations.

**Align the centre of the protractor over the vertex.** Blind students need a way to position the centre of the protractor over the vertex.

- Using a protractor with a hole in the centre: Use touch to position the vertex in the centre of the hole.
- Using a protractor with a slit from centre to edge: Use a pinboard and a pin to position the centre of the protractor over the vertex.

**Align a mark on the protractor over one of the lines.** Rotate the protractor to align a mark on the protractor with one of the lines. Since a protractor for blind students contains no numbers, there is no “zero” or “north” mark, and it does not matter which mark is aligned with the line. This step is therefore a bit easier for blind students.

**Read the angle of the other line.** This step is harder, since students must work with two hands: one hand to hold the protractor and mark the two lines, and the other to count the number of 10-degree marks that separate the two lines.

**Adapted exercises.** Blind students need tactile drawings with lines that are long enough to measure the angles. When correcting exercises, allow students at least a 5-degree margin of error.

### 3.4.6

#### Pythagoras

**Useful for: Blind, Low vision, Sighted**

You can explain Pythagoras' theorem ( $a^2 + b^2 = c^2$  for a right-angle triangle) using a model made of card or wood. This consists of a square board or tray and four right-angle triangles that fit on it to leave a large square in the middle. The triangles have lengths of  $a$ ,  $b$ , and  $c$ . Demonstrate that all four triangles are the same size and shape. Make 3 squares with sides of the same lengths,  $a$ ,  $b$  and  $c$ .

You can rearrange the triangles to make two smaller squares. Explain that these squares have areas of  $a^2$  and  $b^2$ . Confirm this by checking the lengths of the sides of the triangles that form the squares.

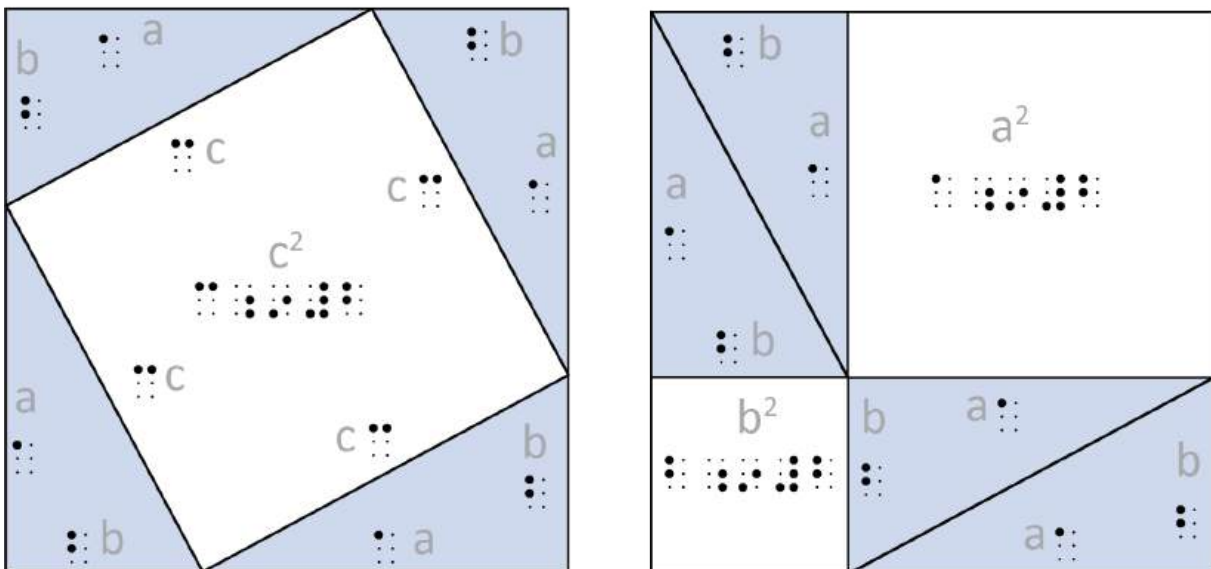

Left: The square in the centre has the area  $c^2$ . Right: Rearrange the triangles to make two smaller squares, with areas of  $a^2$  and  $b^2$ .

Learners can measure the edges of tactile right-angle triangles and perform the calculations. Start with simple triangles with integer sides to avoid using decimals. Suitable lengths include the following Pythagorean triples:

- 3, 4, 5 (and multiples such as 6, 8, 10)
- 5, 12, 13
- 8, 15, 17
- 7, 24, 25.

## 3.4.7

## Trigonometry

Useful for: Blind, Low vision

## Finding values

Sighted students can look up the values for sines, cosines, tangents, etc. in printed tables. But this is very difficult for blind and visually impaired students (see the section on **Tables** below). Instead, consider:

- **Using a calculator or computer** to find the correct values. If necessary, a classmate can read the values out to the blind or visually impaired student.
- **Asking the student to state the number** they wish to look up (e.g., "the sine of 30 degrees"), then giving them the correct value.

## Working with figures

Blind students will need a tactile figure to visualize the problem. See the **Understanding diagrams** section above for an introduction on how to adapt figures.

## Original exercise for sighted learners

Calculate  $\angle \alpha$ .

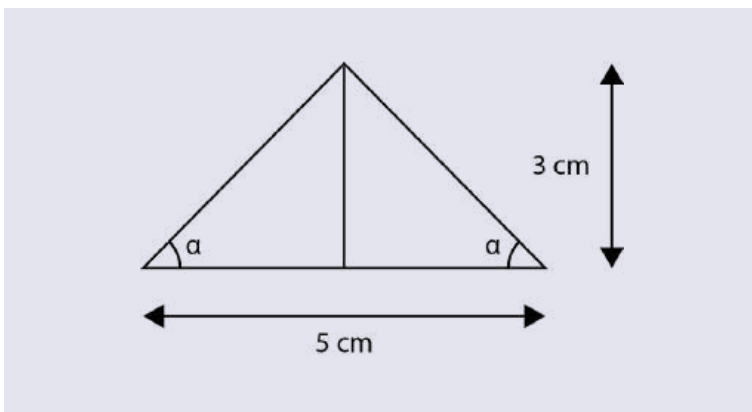

## Adapted exercise: tactile figure + description

Calculate the angle alpha of an isosceles triangle with a base of 5 cm and a height of 3 cm. In the figure, the base is the horizontal line. The height is the vertical line. Angle alpha is the lower left angle of the triangle.

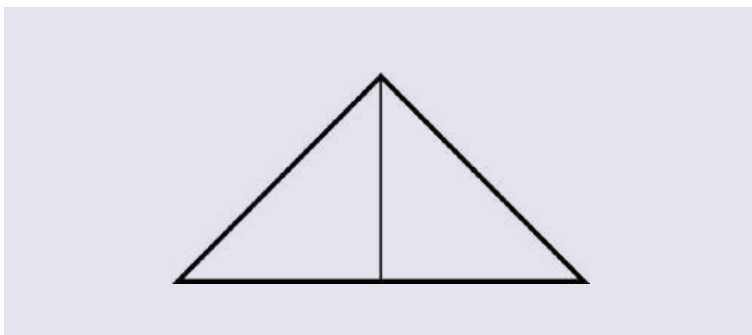

## 3.5 3D geometry

Blind students have particular problems with 3-dimensional geometry because they find it difficult to visualize aspects such as internal angles, and to transfer three dimensions to a 2-dimensional piece of paper, as is necessary with creating and interpreting projections and nets.

See **Part 2: 3D objects and models** for information on tools and equipment you can use for modelling 3D objects.

### 3.5.1 3D geometric shapes Useful for: Blind, Low vision, Sighted

#### 3D shapes

Solid and wire 3D geometric shapes are very useful for all learners. You can give the blind or low-vision student the shape to manipulate while you use a 2-dimensional drawing on the board to explain the concepts to their sighted classmates.

Blind learners often find it difficult to keep track of the number of faces a solid object has. Make this easier by getting them to mark the first face with a loop of masking tape or a blob of plasticine. Alternatively, they can mark each of the faces in the same way, counting the marks as they go.

Learners can make 3D shapes out of plasticine or clay, or construct them from magnetic tiles or magnetic sticks and balls.

They can use a piece of string and a tactile ruler to measure the lengths of vertices or the circumference of a cylinder.

They can use a tactile protractor to measure the external angles of a solid.

#### Objects with different dimensions and proportions

When they encounter a geometric shape for the first time, it can be hard for a blind student to generalize the concept. A sphere is relatively easy shape, but you should still have spheres of different sizes available. Explain that a sphere is defined by its shape, and not by size or function.

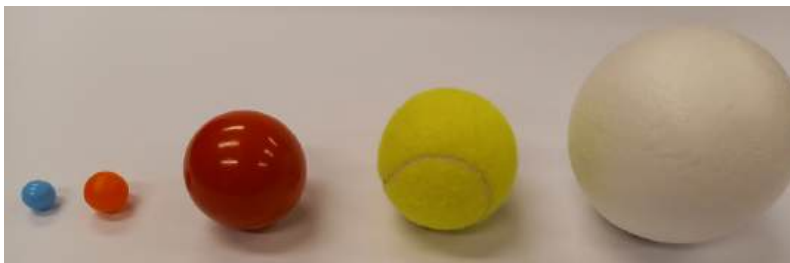

Spheres of different sizes.

With a cylinder or cuboid, it is important that the student encounter objects with different proportions: longer, shorter, thinner, fatter, etc.



Everyday objects with different dimensions as cylinders.

When using everyday objects, explain that a cylinder has three planes: two circles and one curved rectangle. Mention the parts of everyday objects that are not present in a perfect cylinder (handle, cap, rounded edges, etc.).

### 3D coordinate grids

Wire models are especially useful when teaching space diagonals because the student can insert a thin rod into the shape and observe it from different viewpoints.



Models made from welded wire. The one on the left has wax sticks wrapped around the edges to mark a 3D coordinate system.

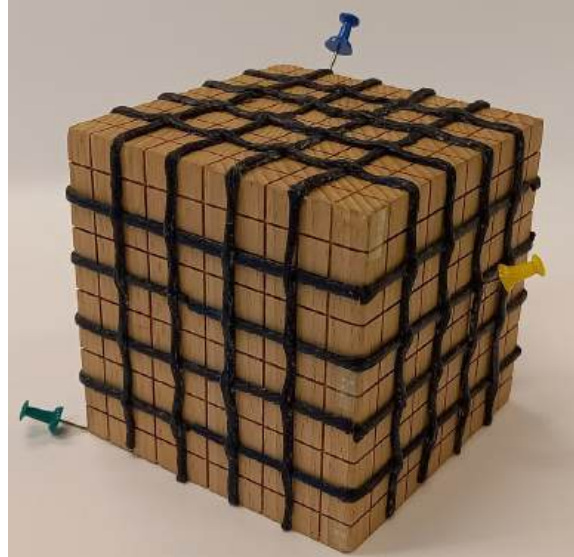

Wax sticks added to a wooden cube to create a 3D-coordinate grid. The green pushpin represents the origin, the yellow pushpin coordinate (5, 3, 3) and the blue one (1, 5, 5). It would have been better to use relief paint instead of wax sticks.

**Drawings of 3D geometric shapes**

To blind students (and to many with low vision as well) 3D drawings are merely a mess of lines. They find it impossible to recognize a geometric shape from such a drawing. So check exercises that use such drawings. Replace the drawings with a description, or skip the exercise completely.

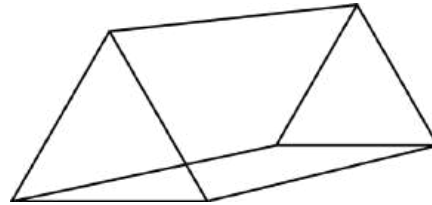
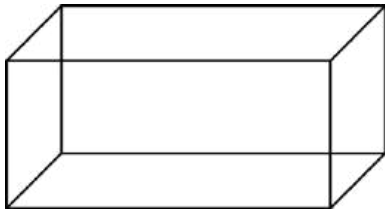

Blind students cannot work with drawings of 3D objects like these.

**Examples**

**Original exercise for sighted learners**

Calculate the volume of the container you see on the picture below.

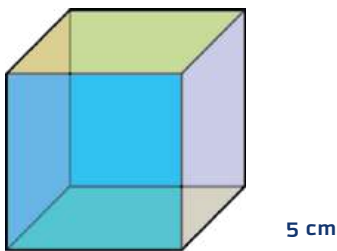

**Adapted exercise: description**

Calculate the volume of a cube with edges of 5 cm.

**Original exercise for sighted learners**

What is the name of the geometric shape below?

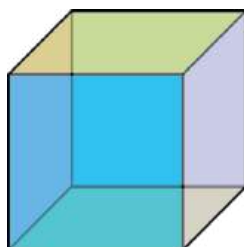

**Adapted exercise**

Give the student a 3D model. Or reword the question:

What is the name of a solid with six square faces?

### 3.5.2

#### Nets

**Useful for: Blind, Low vision**

**Working with figures.** To educate blind students about nets you will need the following materials:

- Nets that are foldable into the corresponding 3D geometric shapes: cube/cuboid, cylinder, pyramid, and prism.
- Tactile drawings of nets.

See **Part 2: 3D objects and models** for examples of nets.

#### Folding a net into the 3D shape

For blind students it is scarcely possible to understand the concept of a net without actually transforming a net into the corresponding 3D shape. So, give them a foldable net and have them fold it into the corresponding 3D geometric shape. Ask them to count the number of faces and name their shapes. The students should memorize the number and shape of the faces that a net is made up of.

#### Recognizing nets from tactile drawings

Once students are acquainted with these interactive nets and have memorized which net belongs to which object, they can learn how to work with tactile drawings of nets. See **Part 2: 3D objects and models** for examples of nets, and **Part 2: Measurement and drawing tools** for materials with which to make tactile drawings.

It takes practice to recognize nets from drawings. This is much more complicated for blind learners than for sighted students because they lack the overview of the net. Sighted students can usually tell at a glance which net belongs to which geometric shape. Blind students have to follow every single line with their fingers, count the number of faces, and memorize the shape of the faces. That takes more time and effort. So give students enough time to practise these skills.

Offer several types of pyramids and prisms with different shapes of the base. This important for the student to generalize the concept of a pyramid and a prism.

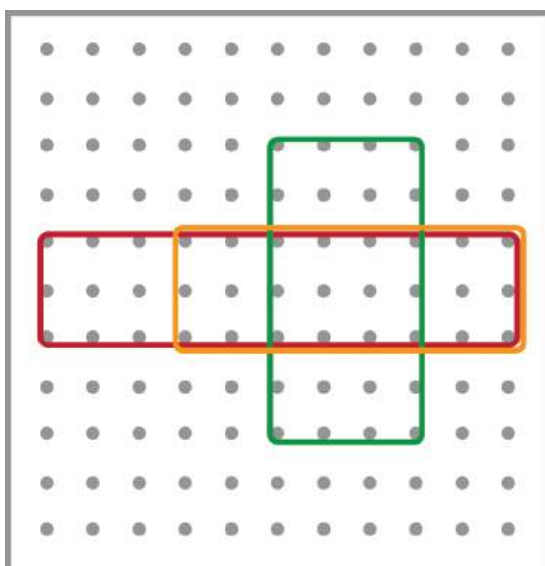

A net of a cuboid made using rubber bands on a geoboard.



**Examples**

Because exploring a drawing of a net tactilely takes time and effort, limit the number of nets that a blind student has to view.

**Original exercise for sighted learners**

For each 3D shape, shade the correct net.

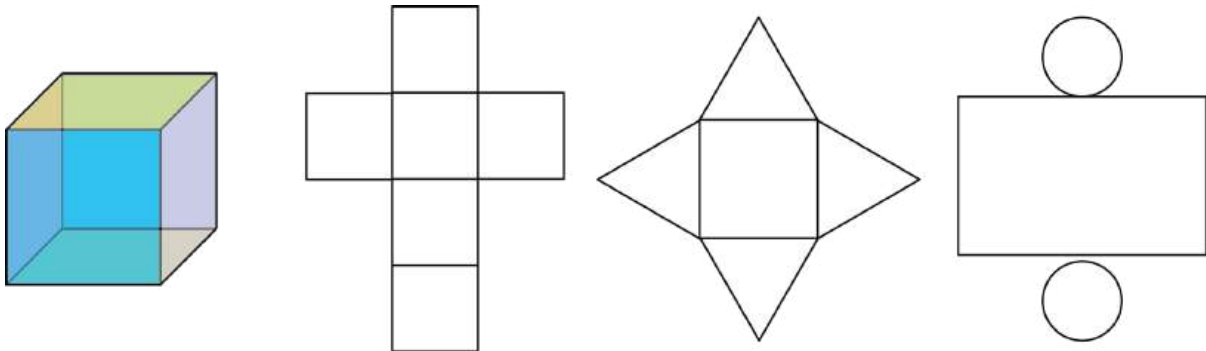

**Adapted exercise**

Name the geometric shape that corresponds with the net.

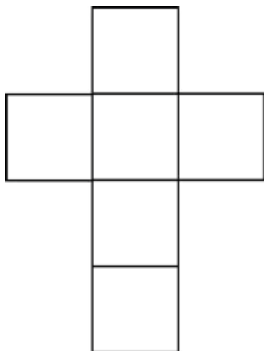

The student must explore only one drawing instead of three.

**Original exercise for sighted learners**

Draw the net of the geometric shape below.

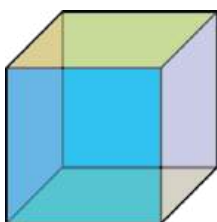

**Adapted exercise**

Draw the net of a cube.

The 3D drawing of the cube is replaced by the one-word description, "cube".

**Original exercise for sighted learners**

Draw four possible nets to form a cube.

**Adapted exercise**

Pick the nets that correctly form the shape of a cube.

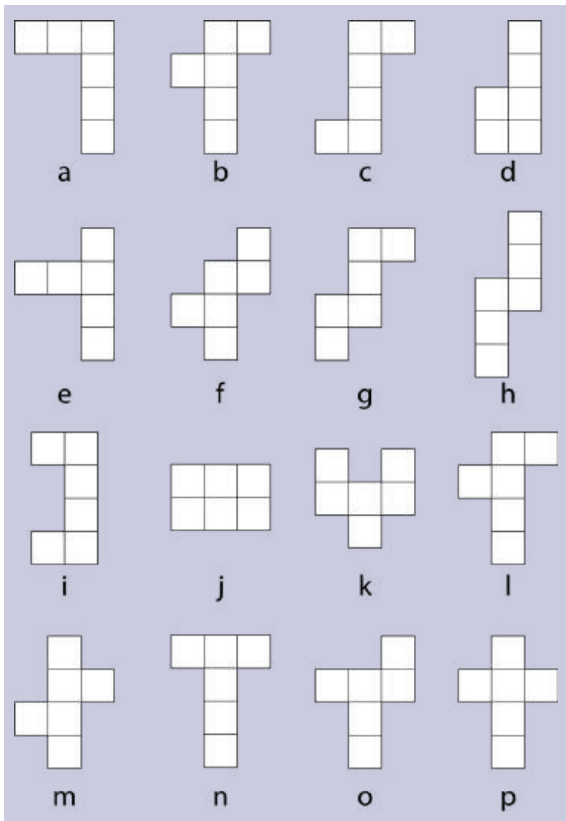

You can reduce the number of nets that blind students have to check.

**Answers**

**Correct:** nets b, c, f, g, h, l, m, n, o, p fold into a cube

**Wrong:** nets a, d, e, i, j, and k do not fold into a cube

### 3.5.3

#### Projections

##### Useful for: Blind, Low vision

Working with projections is extremely difficult for blind students. Sighted students can see that the shape of an object changes with the angle from which you look at it. Depending on the angle, a cylinder will look like a circle or a rectangle.

Blind students cannot see this, and there is no equivalent in touch. They find the idea of a top view, front view and side view very hard to grasp. They will need a lot of training in order to understand the subject.

Nevertheless, it is useful to practise recognizing and drawing simple projections with blind students. After training, students should be able to draw projections of:

- 3D geometrical shapes
- 3D objects that consist of a small number of cubes.

Students should also be able to do it the other way round:

- Recognize a geometrical shape from the projections
- Construct a 3D object that consists of a small number of cubes that corresponds to a set of top, front and side view.

Blind students usually do not learn to interpret or draw projections of more complex structures than the ones described above.

#### Projections of 3D geometrical shapes

Blind students can match projections to the corresponding 3D shape. This is usually more an act of memorization than of understanding. Therefore, give blind students enough materials and time to practice this skill.

**Working with figures.** The materials you need are:

- A variety of 3D geometrical shapes (see **Part 2: 3D objects and models**).
- Drawings of projections of the 3D shapes in different positions (standing upright, lying down). See **Part 2: Drawings and graphs** for examples of materials that you can use to draw projections.

**Discovering the first projections.** When a student encounters a set of projections for the first time, it is important to explain the connection between the drawings of the projections and the actual 3D shape. Below is an example of how to do this for a cylinder. The approach is similar for other geometrical shapes.

Give a cylinder to the student and ask them to place it upright on the table. Ask the student what shape the top plane is. Blind students will usually recognize the circular shape.

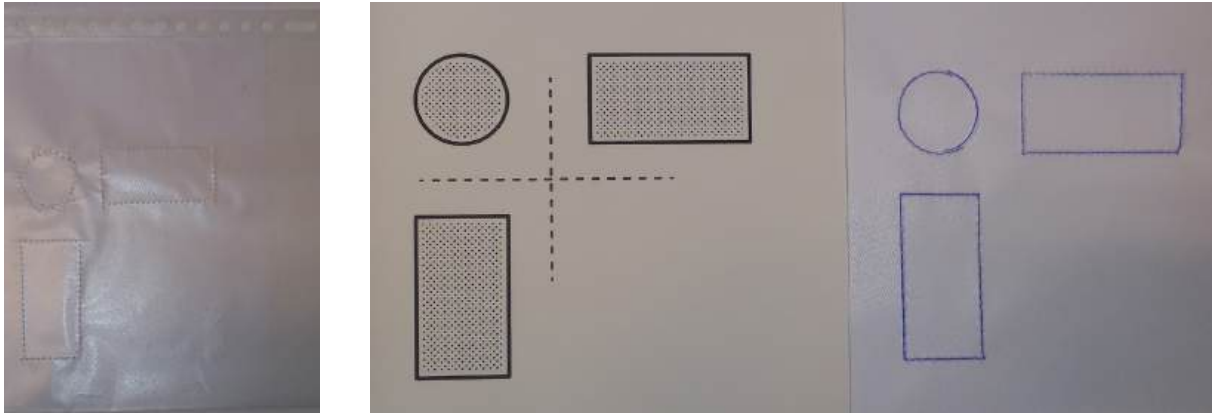

Projections of the top, right and front views of an upright cylinder, made using a plastic file pocket (left), swell paper (middle), and drawing foil (right).

Give the student the tactile drawing of the projections and explain that there are three drawings of the same cylinder on the sheet, but that all drawings are made from different perspectives. The drawing in the upper left corner (the circle) is the top view. And since the upper plane of the cylinder is a circle, the top view is a circle too.

Explain that the rectangle below the circle is the front view. Ask the student to point at the front of the cylinder, to check if they understand the concept of "front". ("Front", "above", "below", and other prepositions can be hard for blind students to understand.)

Next, explain to the student why the front view is rectangular. This is usually very hard for blind students to grasp. Try it like this:

- The position of the hand is important: keep the hand horizontal with the fingers pointing away from the body
- Follow the shape with the side of the hand. Do not follow the edges with the fingertips, because the round shape of the circle will confuse the student.
- Start with the hand flat on the table, with the side of the index finger next to the cylinder.
- Move the hand upwards, with the side of the index finger alongside the cylinder. Ask the student which direction the hand is moving: "up".
- Stop when the hand has reached the top of the cylinder. Now move the hand sideways. Keep the hand horizontal: the palm of the hand will be sliding over the top of the cylinder. Ask the student which direction the hand is moving: "sideways".
- Move the hand down the other side of the cylinder. Direction of movement: "downwards".
- Finish by moving the hand back to the starting position. The hand will move over the table. Direction of movement: "sideways".
- Ask the student to repeat these directions of movement: upwards – sideways – downwards – sideways to the original position. Note that all those movements were along a straight line.
- Then ask, which 2D figure results from drawing 4 straight lines: up – right – down – left? The answer is "a rectangle". This is the shape of the front view in the tactile drawing.

Finally, explain in the same way why the right view is a rectangle too.

When the student understands the projections of this upright cylinder, practise with the projections of the same cylinder when it is lying down.

**Memorizing projections of different objects.** Provide the student with multiple 3D geometrical shapes. For each object, provide the projections in at least two different positions. Ask the student to match each set of projections to the corresponding 3D object, and to position the object in the correct manner. Practise all the various objects that sighted students must learn:

- Sphere
- Cube and cuboid
- Prism with different base shapes, e.g., triangular, six-sided, heart shaped, etc.
- Pyramid with different base shapes, e.g., triangular, square, rectangular, five-sided base and circular (which is a cone).

Stand or lay the object in various positions so the student can practise recognizing and drawing the three projections of each object for different positions.

### Projections of structures that consist of cubes

For blind students, start with projections of structures that consist of 5 cubes. Make the structures no more complicated than 10 cubes.

**Example with Lego and pinboard.** Lego is a good material to use for the objects because the bricks stick to each other and the student can discover the object tactilely without destroying it.

Blind students can make a representation of the top, front and right view with pins, using swell paper (or a plastic file pocket or relief paint or a geoboard) as a grid. See **Part 2: Drawings and graphs** for ways to make a tactile grid.

The student can also use braille cells to represent the positions of the bricks.

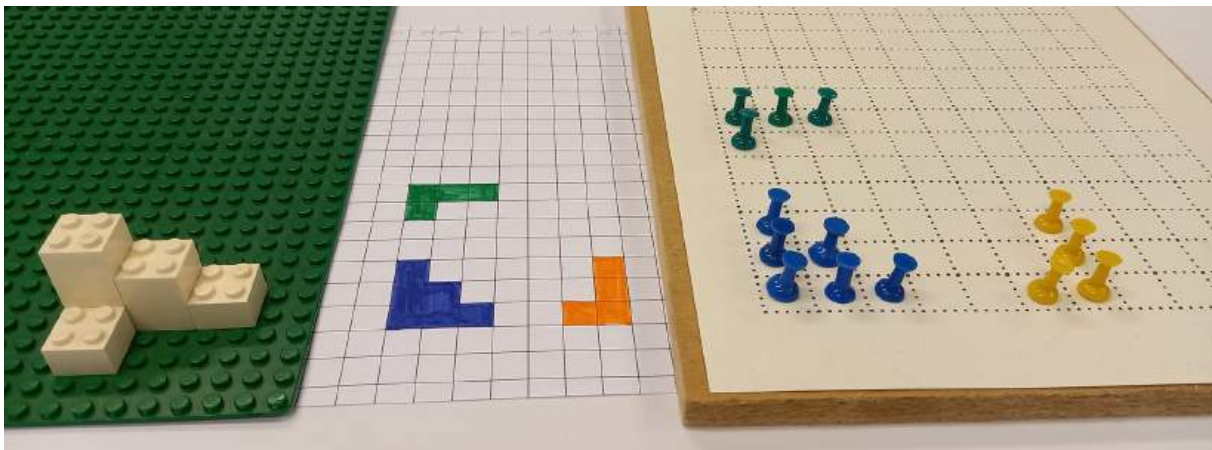

An object made of Lego (left) consisting of 7 bricks ("cubes"). The projections use a grid (centre) and a geoboard with magnetic pins (right). Each pin represents a Lego block.

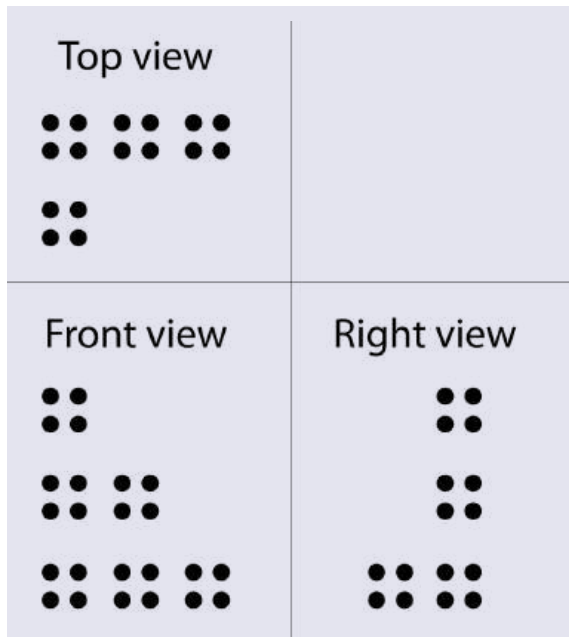

A braille representation  
of the same Lego object.

**Top view.** Start with the top view, as this is usually the easiest projection for blind students. Tell the student that they have to tell for every position (as seen from the top) if there are bricks or not. It does not matter how many bricks are stacked on top of each other. If there are one or more bricks, we will show that with a pin. If there is no brick in a position, we do not place a pin.

Teach the student to work in a structured way: start in the top left corner, and from there proceed to the right.

Since there are three blocks stacked on top of each other, place a pin in the top left corner of the grid. Move one position to the right. There are two bricks on top of each other. Place one pin next to the first one. Move one more position to the right. Here is one brick. Represent this brick with a pin too.

Go back to the starting position: the top left position. Move one position to the front. There is one brick. Represent that brick with a pin.

**Front view.** The next projection is the front view. In this case it **is** important how many bricks are on **top** of each other, but **not** how many of them are **behind** each other.

Start on the left side. Two bricks are behind each other (this is not relevant for the number of pins). The highest stack is three bricks high (this is relevant). Place three pins above each other.

Move one position to the right. Two bricks are on top of each other. Place two pins above each other. Align the lowest of these pins (that can be a very unnatural step for blind students).

Move another position to the right. There is a single brick. Represent that brick with a pin and place that pin to the right of the lower one of the two pins you have just placed.

**Right view.** Ask the student to turn the Lego structure 90 degrees clockwise. The right view has now become the front view. Repeat the steps from the front view.

Start on the left side. There is only a single brick. Place one pin for the right view.

Move one position to the right. There are three stacks of bricks behind each other (this is not relevant for the number of pins). The highest stack is three bricks high (this is relevant). Represent this stack by placing three pins on top of each other. The lowest of these three pins should align with the single pin.

### 3.5.4

#### Cross-sections

##### Useful for: Blind, Low vision, Sighted

For blind or visually impaired students it is hard, or even impossible, to imagine what a cross-section is from just a description or a drawing. That is why we advise using clay to make different cross-sections.

Students should experience what happens when making a cross-section. To gain the insight that a cross section is a plane that is within a 3D figure, they have to disconnect and reconnect the two halves of the shape. If they trace the outline of a cross-section with a marker, it is easier to understand that cross-sections can take many shapes.

The procedure below uses a cube and an example. You can, of course, use the same approach for cross-sections of a cylinder, pyramid, etc.

#### Cross sections of a cube

##### Requirements

- Modelling clay, such as plasticine or Play-doh
- Plastic knife or dental floss to make the cross-sections
- For students with low vision: paper and marker. Use contrasting colours for the Play-doh, the paper and the marker.
- For blind students: a tactile drawing board, such as a rubber mat and drawing foil (for other options, see **Part 2: Measurement and drawing tools**).
- A silicone cube tray is not necessary, but it makes it easy to create many cubes with the same dimensions.



Using Play-Doh or plasticine to make models to cut up in order to find their cross-sections.

Use the ice-cube tray to make a set of cubes of the same size.

**Step 1: Introduction**

**Cut.** Start with a cube. Tell the student that they will cut the cube in two parts. Ask the student if they want to cut it by themselves, or if you should cut it together. Make sure that the cut is straight.

**Definition of a cross section.** Explain that the plane that you have created is called a cross-section. Both halves of the cut cube have a plane with the same shape. Ask the student what shape this cross-section is.

**Two halves still form a cube.** Ask the student to reassemble the cube by putting the two parts together. Only the planes that touch are called the cross-section.

**Trace the outline of the cross section.** Take one half and put it on paper, with the cross-section face down. Ask the student to trace the outline. Students with low vision can use a marker on paper. Blind students can use drawing foil, a plastic file pocket, or another option from **Part 2: Drawings and graphs.**

**Step 2: Discovering all cross sections**

Repeat the process described above to discover all the possible shapes of the cross-section of a cube. The student should trace all the cross-sections to see (or feel) the shape. A blind student will need a tactile drawing board to feel the shape.

The shapes to discover are:

**Square.** Slice the cube straight down, parallel to one of its sides.

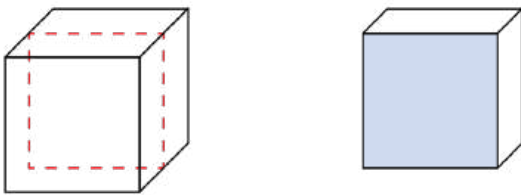

**Rectangle.** Slice the cube straight down, but not parallel to one of the sides.

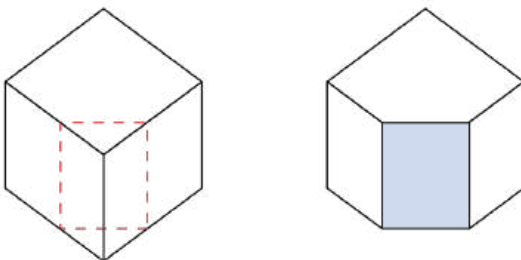

**Triangle.** Cut off one of the corners of the cube.

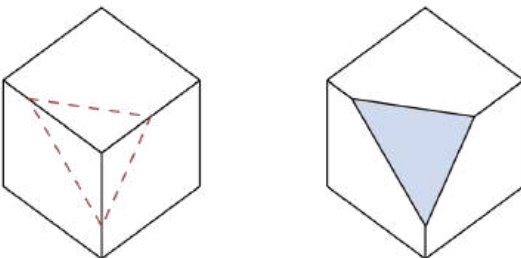



**Equilateral triangle.** Cut off one of the corners, making sure that the cut is an equal distance from the corner on all three edges.

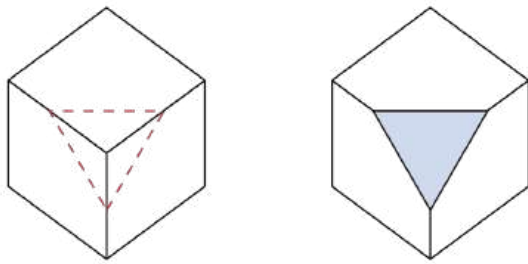

**Pentagon:** Slice the cube so the knife goes through five of the six faces.

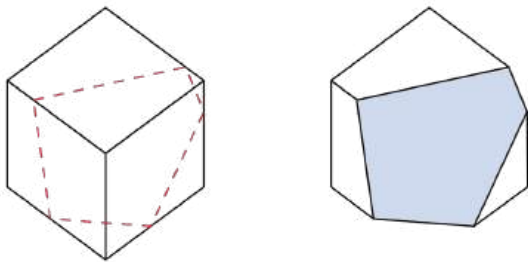

**Hexagon:** Slice the cube so the knife goes through all six faces.

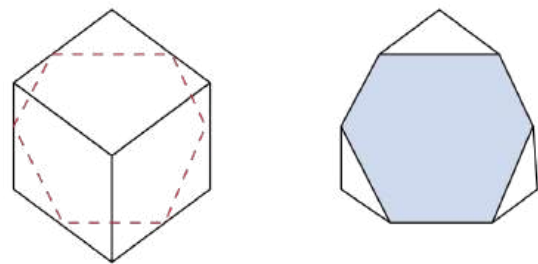

**Parallelogram:** Slice the cube from the top to bottom, but not straight down and not parallel to any of the sides.

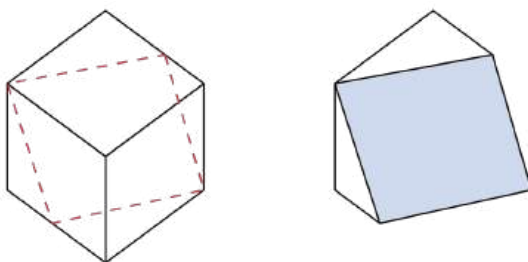

**Step 3: Exercise**

Give the student a few intact cubes. Ask them to create cross-sections with the following shapes:

- a square
- an equilateral triangle
- a rectangle that is not a square
- a triangle that is not equilateral
- a pentagon
- a hexagon
- an octagon
- a parallelogram that is not a rectangle
- a circle.

**Note:** Two cross-sections in the list are impossible to make by slicing a cube: the circle and the octagon. Ask the student to explain why this is the case. Answer: It is not possible to create an octagonal cross-section because a cube has only six faces. It is not possible to create a circular cross-section because the cube has no circular shape.

**Cross-sections of other geometrical figures**

Repeat these steps for other 3D figures, such as a cylinder, cone and pyramid.

**Adapted exercises and tests**

As a rule, you can ask students questions in a test that they have been able to practice during class.

In formal exams, blind and severely visually impaired students should not be confronted with drawings of 3D objects, and they should not have to draw cross-sections.

**Original exercise for sighted learners**

In the picture you see the cube ABCD.EFGH with sides 6 cm long. The points K, L and M are the midpoints of the edges EF, BF and FG.

- a. Draw the cross-section KLM at a scale of 1 to 1.
- b. Calculate the length of KM.
- c. Calculate the area of the cross-section KLM.

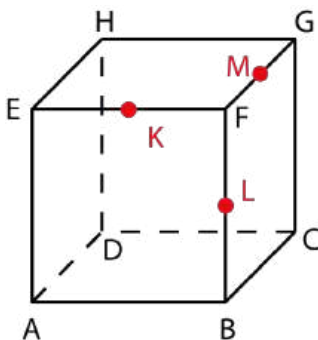

**Adapted exercise**

Questions where sighted students must draw cross-sections are generally replaced by alternative questions that deal with the subject, but do not require drawing. Examples:

Name three shapes a cross-section of a cube can have.

Name two shapes a cross-section of a cube can never have.

A cross-section of a cube is made by cutting it into two halves. The cube is cut parallel to the top plane. What is the shape of this cross-section?

A cross section is made of a cylinder by cutting the cylinder into two halves with equal volume. The cylinder is standing upright, so one of the circular planes is the bottom plane and the other one is the top plane. What is the shape of a vertical cross section? What is the shape of a horizontal cross section?

Since blind or severely visually impaired students do not work with drawings of 3D shapes, the figure from the original question can be replaced by one or more two-dimensional drawings. The question could be like this:

The first drawing shows a cross section KLM, taken from a cube with sides 6 cm long. Triangle KLM is an equilateral triangle.

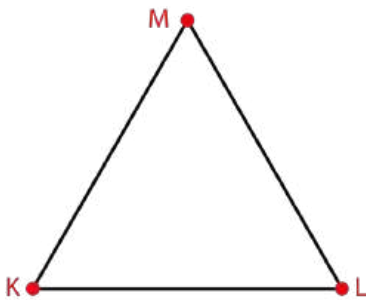

The second drawing shows the top view of the cube EFGH with sides 6 cm long. Points K and L form the midpoints of edges EF and FG.

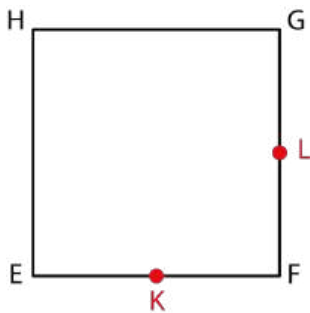

- Calculate the length of KL.
- Calculate the area of the equilateral triangle KLM.

### 3.5.5

#### Space and face diagonals

**Face diagonals** connect two vertices on the same face of a solid figure. **Space diagonals** connect two vertices on different faces. They are also known as “body diagonals” or “interior diagonals”.

First give the student a wire frame model of the 3D geometric shape (see **Part 2: 3D objects and models**). Give the student a thin rod so they can explore the various diagonals.

Explain the concepts of face and space diagonals. Face diagonals are easy to understand as they are the same as in plane geometry. Explain that a face diagonal connects two vertices that are on the same face, but not the same edge. Help the student to position the rod in different positions that represent a face diagonal.

Second, explain that a space diagonal connects two vertices that are not on the same face. Help the student to position the rod in different positions that represent a space diagonal.

Third, ask the student to count the number of space diagonals the geometric shape has (4 in a cube or cuboid) and to count the number of face diagonals (12 in a cube or cuboid). These questions check if the student has understood the two concepts and the difference between them.

#### Pythagoras’ theorem in 3D

The generalization of the Pythagorean theorem to 3D is also called “de Gua’s theorem”. The student must already be familiar with Pythagoras’ theorem in 2D.

When the student has understood the difference between a face and a space diagonal, they can learn which variant of Pythagoras’ theorem to apply.

- $a^2 + b^2 = c^2$  for face diagonals
- $a^2 + b^2 + c^2 = d^2$  for space diagonals.

As soon as they know this rule, you can start doing calculations.

#### Step 1: with 3D wire model

When a student has to calculate the length of a space diagonal for the first time, have a wire model available. It helps the student to “walk” with their index finger along the three edges from one vertex to the other. This lets them identify which numbers to use for a, b and c.

#### Step 2: space diagonal without 3D model or 2D drawing

After the student understands how to calculate the length of the space diagonal, you can give exercises without the 3D model.

**Original exercise for sighted learners**

Calculate the length of the space diagonal ED.

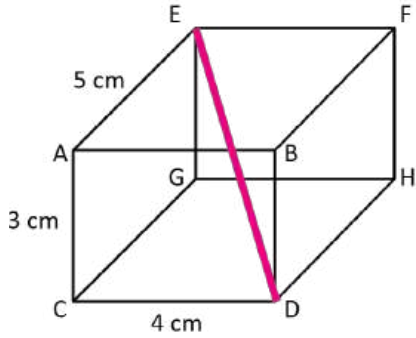

**Adapted exercise**

Calculate the length of the space diagonal of a cuboid with length 3 cm, width 4 cm and height 5 cm.

**Original exercise for sighted learners**

Calculate the length of the longest pole that can be transported in this van.

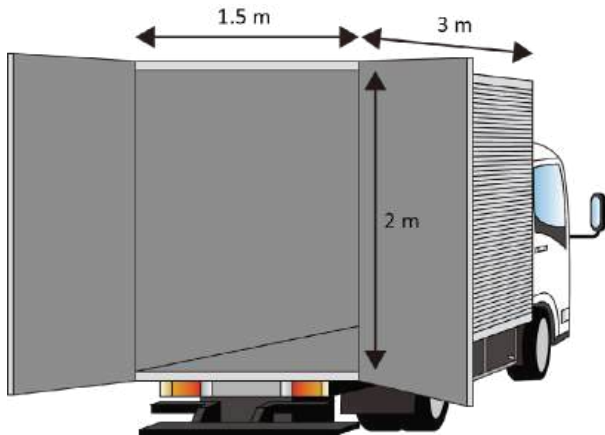

**Adapted exercise**

Calculate the length of the longest pole that can be transported in a van with a cargo space of 1.5 m wide, 2 m high and 3 m deep.

Blind students cannot work with 3D drawings on paper. So either use a 3D model, or no drawing at all. If student has no or little visual memory, take more time and explain more.

**Step 3: Calculate space and face diagonals with 2D drawings**

For this, the student has to distinguish between the 2D and 3D variants of Pythagoras' theorem.

**Original exercise for sighted learners**

Three identical isosceles right-angled triangles form the sides of the pyramid ABCT. The right angles touch at point T.  $AB = BC = AC = 50$  cm. Calculate the length of AT. Calculate the height of the pyramid.

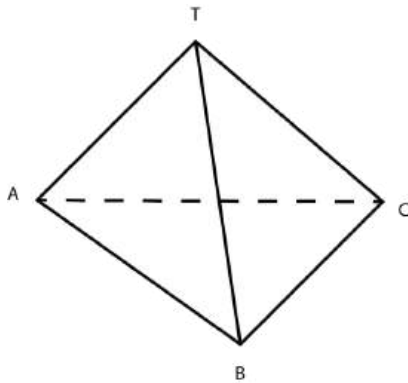

**Adapted exercise**

Since blind students cannot understand 3D drawings, use drawings of 2D planes and adapt the description. Alternatively, give them a model of the pyramid.

A pyramid has a base in the form of a triangle, ABC. Each side measures 50 cm. The top of the pyramid is point T. The sides of the pyramid all form right angles at T. Calculate the length of AT. Calculate the height of the pyramid.

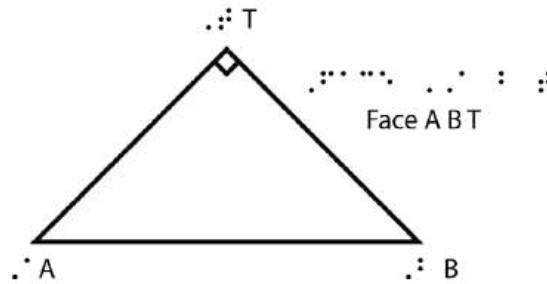
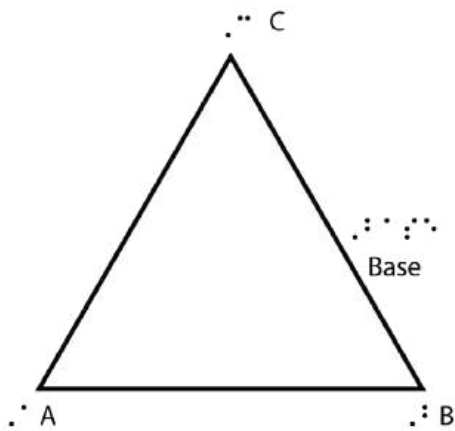

#### Step 4: Apply Pythagoras' / de Gua's theorem in a three-dimensional coordinate system

##### Original exercise for sighted learners

Calculate the length of a wire that is spanned between coordinates (0, 0, 3) and (1, 6, 1).

Most blind or visually impaired students cannot imagine this situation, so they must rely on a trick to solve exercises like this.

1. Calculate the difference between the x coordinates\*:  $1 - 0 = 1$
2. Calculate the difference between the y coordinates\*:  $6 - 0 = 6$
3. Calculate the difference between the z coordinates\*:  $3 - 1 = 2$
4. Insert the results in  $a^2 + b^2 + c^2 = d^2$ :  $1^2 + 6^2 + 2^2 = 41 = d^2$
5. Calculate the answer:  $\sqrt{41} = 6.4 \text{ m}$

\* take absolute values.

If one of the values is zero, the exercise is about a face diagonal (and not a space diagonal) and the student can use  $a^2 + b^2 = c^2$  instead of  $a^2 + b^2 + c^2 = d^2$ .

### 3.5.6

#### Magnification factor

Useful for: Blind, Low vision, Sighted

##### Recognizing magnification

Blind learners may have difficulty recognizing that two objects of different sizes have the same shape. To teach this, it is useful to have:

- 3D shapes that are magnifications of each other, such as balls, matryoshka dolls or stacking toys
- 3D shapes that are not magnifications from each other, such as cylinders of different dimensions.



Check that students understand that the balls (left) have the same shape and are magnifications of each other, but the cylinders (middle) are not magnifications from each other, even though they all have a cylindrical shape. To train this concept, it is helpful to practise this first with 2D objects (right).

See **Part 2: 3D objects and models** for materials to demonstrate magnification factor.

##### Calculating volumes

There are two easy ways to show blind students that the volume increases cubically with the length.

**Method 1.** Fill a small hollow object (such as a matryoshka doll) with water and pour this water into an object with the same shape, but double (or triple) the length. Count how many doses of water you need to fill the bigger shape. Of course, the thickness of the material influences the accuracy of the measurement, but it works.

**Method 2.** Build cubes of various sizes from a number of 1 cm cubes or Lego blocks. Lego cubes work very well for this, because students can fix them to each other and discover the structure without destroying it.

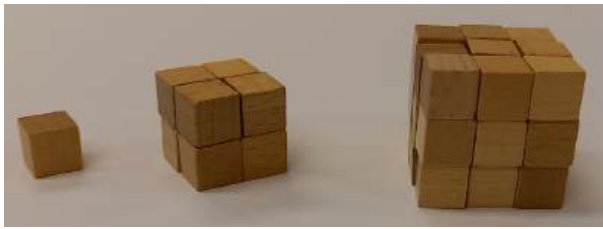

Cubes demonstrating that volume increases cubically with length.

### More information

Willings, C. Teaching students with visual impairments: Geometry & spatial adaptations.

<https://www.teachingvisuallyimpaired.com/geometry--spatial-sense.html>

## 3.6 Graphs

A graph is visual way of representing data. Blind and visually impaired students will therefore need help to understand the concept of a graph.

### 3.6.1

#### Verbal support

Useful for: Blind, Low vision, Sighted

**Part 1: Teaching techniques** gives general guidelines on verbal support. Here we give hints on how to introduce the vocabulary related to graphs and coordinate systems, and how to give specific verbal support when describing a graph.

#### Tactile drawings

Students will benefit most from the verbal support if they have a (tactile) drawing to explore while listening to the verbal support. See **Part 2: Drawings and graphs** for different ways to making a tactile graph. Even if no tactile drawing is available, students will benefit from the verbal descriptions.



A bar graph made with rows of embossed dots, braille pasted on to label the axes, and sand glued on the paper to form the bars.



### Verbal support in a class situation

If you are very specific in describing a graph, most blind and visually impaired students will be able to make a mental image of it. For example, say “top-left corner” instead of pointing at the top-left corner and saying “here”.

Elements to mention when describing a graph are:

#### The characteristics of the coordinate system

- The number of quadrants
- Position of the axes
- Step size on the x axis
- Step size on the y axis.

#### The shape of the graph

- Where to find the curve, such as a position:

The curve runs through the top left corner of the grid.

- Or the coordinates of an intercept that make the graph easy to find amongst the grid lines:

The curve runs through the origin.

- Whether the curve is constant, increasing or decreasing.
- Whether the increase or decrease is linear, concave upward, or concave downward.
- Terminology for function types, such as parabola and hyperbola.

#### The coordinates of specific points or characteristics

- x intercept
- y intercept
- Vertex
- Starting point (for square root functions)
- Asymptotes (inverse proportional functions).

### Example of verbal support: introducing the coordinate system

The examples below suggest the verbal support that you could give when introducing the cartesian coordinate system (with one or more quadrants). The boldfaced words indicate wordings that are specific and so essential for useful verbal support. Maths vocabulary is shown in **red**. Both blind and visually impaired and sighted students will benefit from this specific description.

See **Part 2: Drawings and graphs** for tips on how to make a tactile drawing of a coordinate system for a blind or visually impaired student.

### Cartesian coordinate system with one quadrant

The **cartesian coordinate system** consists of two **axes**. One is **horizontal (from left to right)** and the other one is **vertical (bottom to top)**. You will find the horizontal axis at the **bottom of this drawing** and in maths it is usually called the **x axis**. You can find the vertical axis at the **very left of this drawing** and it is usually referred to as the **y axis**.

The point where the two axes **intersect** is called the **origin**. The origin is located at the **bottom left corner** of this coordinate system.

### Coordinate system with four quadrants

The description of a coordinate system with more quadrants is essentially the same as the description above, but be sure to describe the positions of the axes and the origin so the student can identify these in the figure.

In this **coordinate system** the **origin** is at the centre. The **x axis** runs from **left to right** through the centre of the coordinate system. The **y axis** runs from **bottom to top** through the centre of the coordinate system.

The top right quadrant is called **quadrant 1**.

The top left quadrant is **quadrant 2**.

The bottom left quadrant is **quadrant 3**.

The bottom right quadrant is **quadrant 4**.

### Coordinate system with two quadrants

In this **coordinate system** the **origin** is at the **left** of the coordinate system, **halfway between the top and bottom**. The **x axis** runs from **left to right** through the origin of the coordinate system. The **y axis** runs from **bottom to top** through the origin of the coordinate system.

When you have introduced the coordinate system with multiple quadrants, you can use it describe the position of a curve. For example:

You will find a **parabola** in **quadrant 1**.

### Finding a position in a coordinate system with a positive quadrant only

A **coordinate system** is a way to mark specific positions and to write down these positions. In a **cartesian coordinate system**, there are two **axes**: the **x axis** and the **y axis**. So we need two **coordinates** needed to specify a position. These coordinates are written in between parentheses like this:  $(x, y)$ . So first an open parenthesis, then give the **x coordinate**, then the **y coordinate**, and then a close parenthesis.

- The x coordinate specifies how far **to the right** a specific point is.
- The y coordinate specifies how far **up** a specific point is.

To find a point with coordinates  $(x, y)$ , do like this:

- Put your index finger at the origin.
- Count x positions to the right.
- Count y positions upwards.
- This is the position of the coordinate.

For example, you find the position of a point with coordinates  $(2, 3)$  like this:

- Position your index finger at the origin.
- Count 2 positions to the right.
- Count 3 positions upwards.
- This is the position of  $(2, 3)$ .

### Finding a position in a coordinate system with four quadrants

So far, x coordinates have always been positive numbers, and y coordinates too. But x and y can be **negative numbers** too.

If the x coordinate is a negative number, count x positions to the left (instead of to the right).

If the y coordinate is a negative number, count y positions to down (instead of up).

For example, you find the position of a point with coordinates  $(-4, -5)$  like this:

- Position your index finger at the origin.
- Count 4 positions to the left.
- Count 5 positions downwards.
- This is the position of  $(-4, -5)$ .

### Describing the shape of a curve: Increasing, decreasing and constant

A graph is read from left to right. If you follow the curve from left to right, it can do one of three things:

The curve goes up: it is **increasing**.

The curve goes down: it is **decreasing**.

The curve stays flat: it is **constant**.

In a graph, a curve may first be increasing, then be constant, and then be decreasing.

Or it may be these in any other order.

More descriptions

To describe the shape of a graph more specifically, one can also use the words:

- **Increasing and concave upward** (also called **convex**): the curve is rising at a higher and higher rate, so it is getting steeper.
- **Increasing and concave downward** (also called **concave**): the curve is rising, but the slope is going down, so the curve gets less and less steep and will eventually be constant or start decreasing.
- **Decreasing and concave upward** (also called **convex**): the curve is decreasing, but at a slower and slower rate, so it will eventually be constant or start rising.
- **Decreasing and concave downward** (also called **concave**): the curve is decreasing at a higher and higher rate, so it is getting steeper.

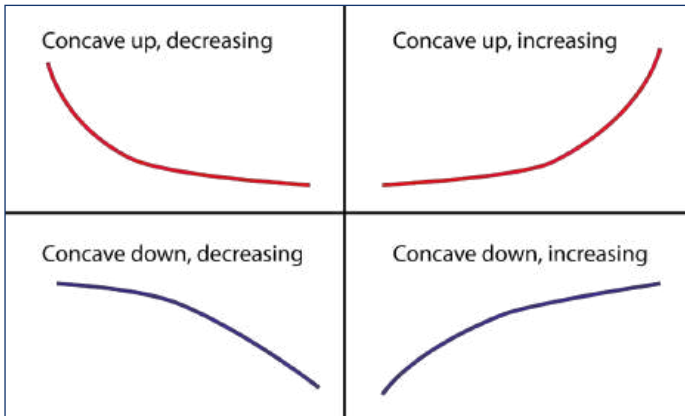

Four types of concave curves.

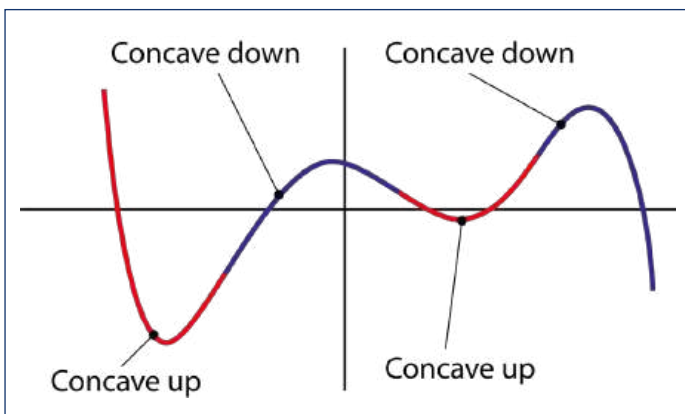

A curve may have several segments that require different descriptions.

### 3.6.2

#### Tactile graphs

Useful for: Blind, Low vision

See **Part 2: Drawings and graphs** for guidelines on how to make tactile graphs. This section focuses on how to support students in using them.

#### Supporting students when working with tactile graphs

Blind or visually impaired students lack the overview of an image that comes naturally for sighted students. So you need to train the student in how to work with a tactile image and give them enough verbal support (see above). For example, tell the student in which quadrant, or on which axis, to look for a specific detail.

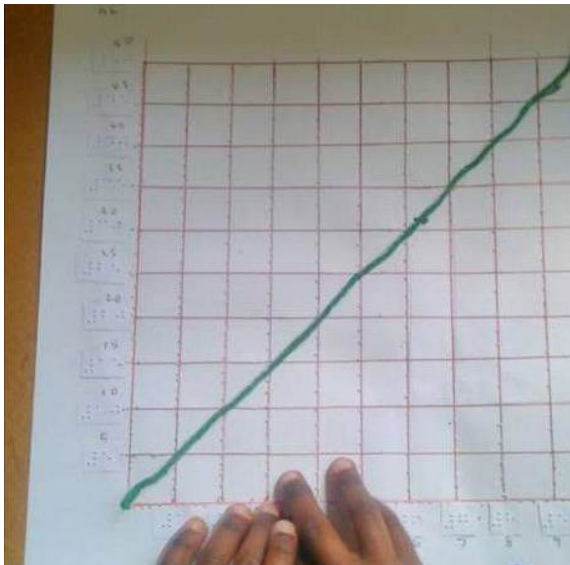

A tactile graph with the axes labelled in braille and using lines of embossed dots as the grid.

Students will have a better understanding of a tactile drawing if they first explore the overall image and only afterwards look for details. This is important, because blind students easily miss information, so they should first be aware of everything that is on the page. The following questions help a student to first get an overview and then look for details:

- What part of the page does the image cover?
- Is there text with the image? For example, with information about the axes?
- Are there grid lines? Axes?
- Is the graph increasing or decreasing? Is it a straight line (linear function) or do you recognize the shape of another function?
- Are there x or y intercepts?
- Is there more than one curve? Are there intersections between the two curves?

Consider asking the support maths teacher to train the student on how to tactilely read a graph.

### Students drawing tactile graphs

If blind or visually impaired students draw graphs themselves, this will improve their understanding of the mathematical concepts.

**Part 2: Drawings and graphs** describes different techniques to draw graphs. Blind students can use most of these to produce their own drawings. A reusable coordinate system forms a valuable basis. This may be homemade (such as made from a plastic file pocket, or using relief paint on paper), or a ready-made coordinate system (such as a geoboard or a Taylor frame).

Instead of asking blind or visually impaired students to draw a graph, give them several different graphs and ask them to choose the one that is correct. For example:

Which of these graphs shows a quadratic equation?

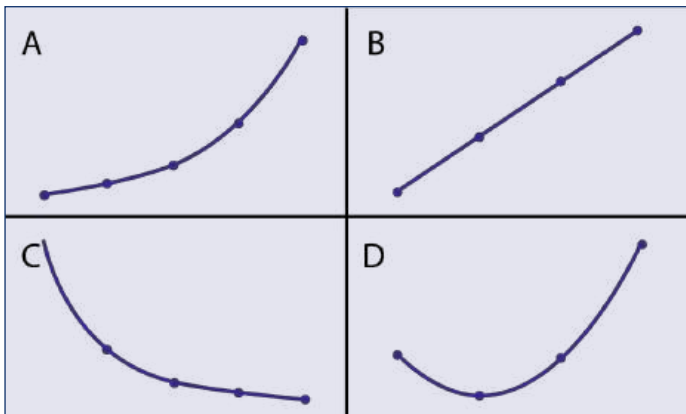

### Using pushpins in a coordinate system

Students can use pins to mark the coordinates of the curve, and span elastic bands around them to depict the shape of the curve.

The advantage of a home-made coordinate system over a ready-made one is that the student is not restricted to pre-determined position of pins. They can place pins on positions in between the grid lines.

It may require some practice, but do not hesitate to challenge your blind and visually impaired students to start drawing. This will improve their understanding of the maths and give them a great experience of inclusion.

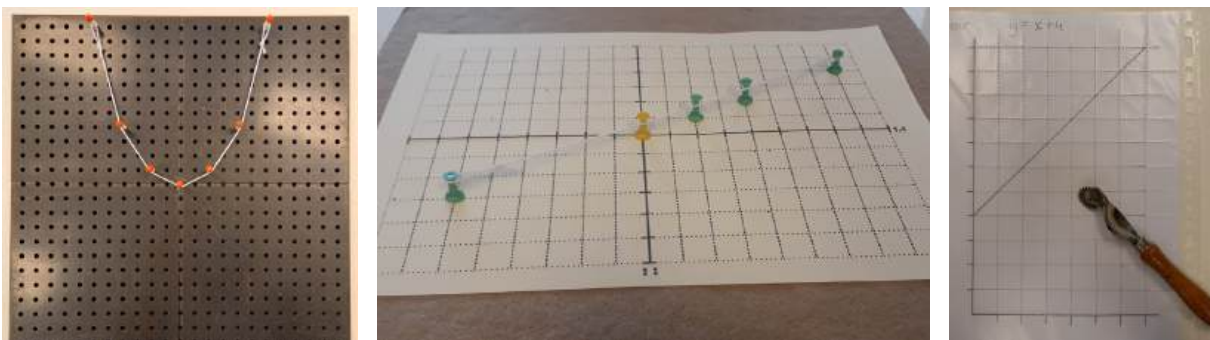

Graphs using various reusable coordinate systems: geoboard (left), swell paper (centre) and plastic file pocket (right).

### Drawing a pie chart

Students can draw a pie chart with a 360-degree protractor. See **Part 2: Measurement and drawing tools** for examples. The steps to draw a pie chart are:

1. Mark the centre of the pie with a pen or a pushpin.
2. Place the protractor over the centre and draw a circle around the protractor.
3. Mark the 0-degree point with a dash or a pushpin.
4. Mark the other sectors too.
5. Use a ruler to draw the sectors. If you have used pushpins to mark the centre and the sectors, it is easy to place the ruler against the pushpins and draw the line.

### 3.6.3

#### Alternatives for working with tactile graphs

##### Useful for: Blind, Low vision, Sighted

Drawing tactile graphs is a time-consuming activity, both for teachers and students. When a student encounters a new topic, they should gain the tactile experience of feeling **and** creating a graph. But as soon as a student is familiar with a concept (coordinate system, linear function, parabola, periodic function, etc.) it is more efficient to switch to alternatives, in which formulas, tables and descriptions are used to create a mental image of a graph instead of a physical one. This will save both student and teacher time and effort by avoiding having to draw lots of graphs.

Below are suggestions on how to adjust exercises for blind students and topics where blind and visually impaired students will need extra instructions. Those are beneficial for sighted students too.

#### Descriptions

You can use descriptions of graphs during instruction to ensure that blind and visually impaired students can understand what you are talking about. It will help if students have a tactile (or enlarged) graph available so that they can tactilely observe what you are talking about.

In exercises where sighted students must draw a graph, you can give blind and visually impaired learners an alternative assignment to describe the graph instead. This works for homework as well as exams. Below are two examples.

If sighted students must draw a graph based on a formula, they usually make a table first. Blind and visually impaired students should do so too.

When describing a graph in a classroom, you can use the terms listed in the section on **Verbal support in class situation**. The students can use the same terms. When asking a student to describe a graph, be very specific about which elements you want to see in the description. Sighted students also benefit from these very specific descriptions of graphs.

#### Examples

Give clear instructions on what elements should be in the description. Practise this with the student.

#### Original exercise for sighted learners

Draw a graph for the formula  $y = 500x + 200$  for  $0 < x < 10$ .

**Adapted exercise**

Describe the curve for the formula  $y = 500x - 200$  for  $0 < x < 10$ . In your description, mention:

- the shape of the curve
- whether it is increasing or decreasing
- the coordinate(s) of the x intercepts
- the step size on the y axis.

**Original exercise for sighted learners**

Draw a graph for the formula  $y = 0.5x^2 - 2$  for  $-5 < x < 5$ .

**Adapted exercise**

Draw a graph for the formula  $y = 0.5x^2 - 2$  for  $-3 < x < 3$ .

Note that the domain in the adjusted exercise is smaller. Since working in braille is time-consuming, adjust the scope of the exercises for braille students. It is advisable to adjust the number of exercises too.

**Formulas**

With blind and visually impaired students it is extra important to explain the relation between the shape of a curve and the characteristics of a formula. Students should learn these by heart. They can use this knowledge to describe a curve as an alternative for drawing it.

Examples of descriptions of curves			
Name	Shape of graph	Example	Formula characteristics
Linear	Straight line (increasing/ decreasing)	$y = 3x - 2$	None of the characteristics below
Quadratic	Parabola (concave/convex): An arch that goes down and then up again (or up and down again) and is mirror symmetrical	$y = 3x^2 - 2x$	Variable is squared, but no higher powers are present
Square root	Arch with a starting point: it does not extend infinitely to the left and right	$y = \sqrt{2x}$	Contains a square root
Inverse proportional	Two arches that have rotational symmetry and are separated by two asymptotes	$y = \frac{7}{x}$ $x * y = 7$	Division by the variable



### 3.6.4

#### Using tables

Useful for: **Blind, Low vision, Sighted**

The section on **Tables** shows how both teachers and students can create tables in braille.

Students can use tables in two ways. If the exercise for sighted students is to draw a curve based on a formula, blind and visually impaired students can use the table as a tool to describe a curve as an alternative to drawing it. If sighted students must tell from a curve what type of function it is (linear, exponential, etc.), blind and visually impaired students can get the same information from a table.

#### Determine the shape of a curve from a table

Tables are useful tools to create mental images of graphs. They can be used to check whether a curve will be increasing or decreasing. They can also be used to find zeroes or intersections between two functions.

Students must be able first to calculate  $y$  values using a formula. They can use this skill to make a table and acquire information about the shape and characteristics of a curve.

#### Determine function type (or even a formula) from a table

Most students learn to recognize different types of functions from a table. This skill is especially important for blind and visually impaired students because they can use it as a shortcut to determine the type of function without having to drawing a graph first.

Explain how to use a table to find out if a function is linear, quadratic, inverse proportional, etc. This will also help students to describe the shape of a graph.

Students can also use this strategy to derive a formula from a table. Both sighted and blind and visually impaired students can do this, but whether they should learn it depends on the maths level.

Below are some examples of the strategies to determine function type from a table.

**Linear function**

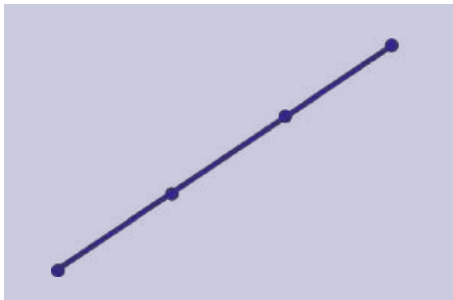

The difference between successive values of y is the same for every value of x:

$y = 4x - 7$							
x	0		1		2		3
y	-7		-3		1		5
		+4		+4		+4	

Alternative notation for braille students:

x	0	1	2	3
y	-7 [+4]	-3 [+4]	1 [+4]	5 [+4]

or

x	0	1	2	3
y	-7 [-> +4]	-3 [-> +4]	1 [-> +4]	5 [-> +4]

**Quadratic function**

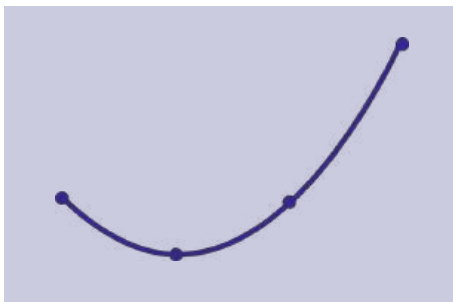

The second-order difference between successive values of y is the same for every value of x:

$y = 2x^2 - 4x - 3$							
x	0		1		2		3
y	-3		-5		-3		3
		-2		+2		+6	
			+4		+4		

For braille students:

x	0	1	2	3
y	-3 [-2] [[+4]]	-5 [+2] [[+4]]	-3 [+6] [[+4]]	3

**Inverse proportional function**

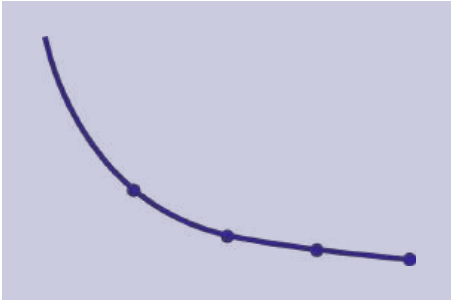

x multiplied by y is the same for every value of x (unless x is zero):

$y = 2x^2 - 12x + 22$					
x	0	1	2	3	4
y	-	12	6	4	3
		$1 \times 12 = 12$	$2 \times 6 = 12$	$3 \times 4 = 12$	$4 \times 3 = 12$

For braille students: same as above

**Exponential function**

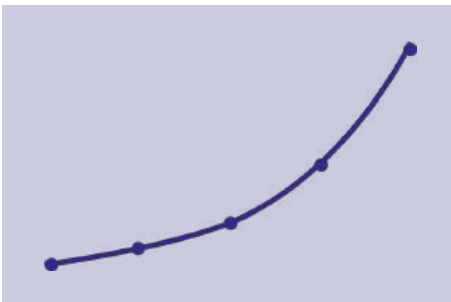

Successive values of y are a multiplication of the previous value by a constant factor:

$y = \frac{1}{2} \cdot 2^x$							
x	0		1		2		3
y	0.5		1		2		4
		*2		*2		*2	

For braille students:

x	0		1		2		3
y	0.5		1		2		4
		$0.5 \times 2 = 1$		$1 \times 2 = 2$		$2 \times 2 = 4$	

### 3.6.5

#### Audio graphs

**Useful for: Blind, Low vision, Sighted**

It is possible to represent the shape of a graph in audio: an increasing frequency implies that the graph is increasing.

This audible representation of a graph can be done by “singing” or with the use of an app. Singing is easier and can be done by both the teacher and the class. It can be extended into a quiz form for the whole class. See below for possible apps.

Some students benefit from audio graphs as an addition to a tactile graph. The audio gives a first overview of the graph, for example about the shape of the graph. Next, the student can use the tactile graph to look for details, such as the coordinates of an intercept.

#### Sensemooth

Sensemooth is an app that is free and available for iPhone and iPad. The app is fully functional for blind people. It will play the sound of multiple graphs after one another, and indicates the position of intersections with a click.

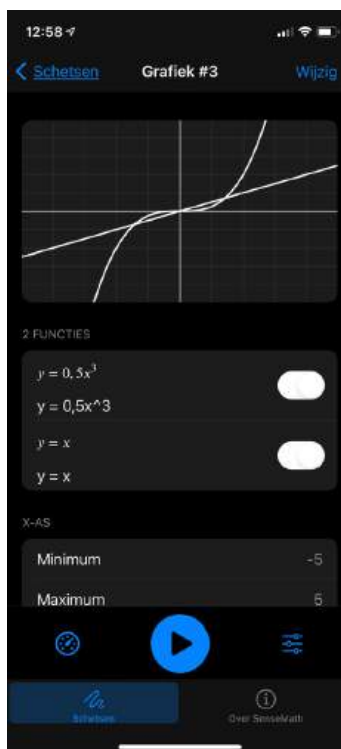

Audio graphs shown in Sensemooth.

#### More information

<https://www.visio.org/en-gb/professional/expertise/onderzoeken/digitale-ontwikkelingen-innovaties/sensemooth>

## Desmos

Desmos is a graphing calculator that is available as an app for smartphones and as a web app for desktops. It has several accessibility features.

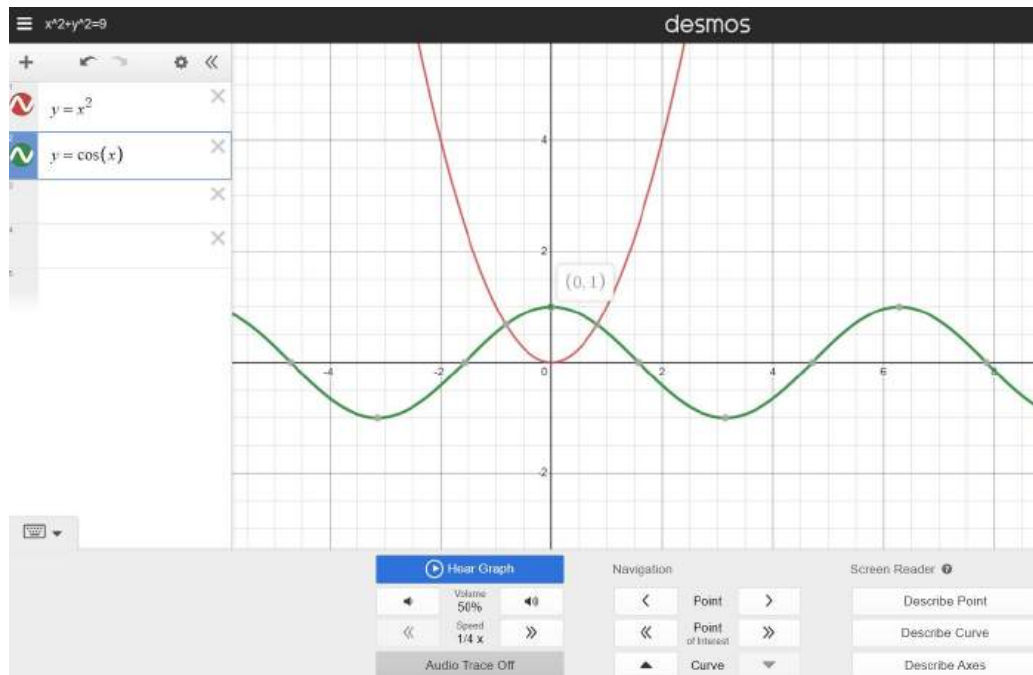

### Desmos.

It works with screen readers on Windows (JAWS, NVDA, Microsoft Narrator), Apple (VoiceOver), Android (TalkBack) and Chromebook (ChromeVox).

It has a range of keyboard shortcuts to avoid users having to click a mouse or tap on the screen.

It has an audio trace mode that plays an audio version of a curve: higher pitch for higher y values, a change in pitch when the trace crosses an axis, and popping sounds when it hits set points.

### More information

[desmos.com/calculator](https://desmos.com/calculator)

<https://help.desmos.com/hc/en-us/articles/4406040715149-Getting-Started-Desmos-Graphing-Calculator>

<https://www.desmos.com/accessibility>

## 3.6.6

### Three-dimensional coordinate systems

#### Useful for: Blind, Low vision

Blind and visually impaired students usually get a basic introduction to three-dimensional coordinate systems with the help of 3D figures (see **Part 2: 3D objects and models**). The section **3D geometry** above describes how to raise the awareness of blind and visually impaired students on 3-dimensional shapes in a coordinate system.

It is impossible to create a tactile, 2-dimensional representation of a 3-dimensional object that blind or severely visually impaired students can understand. Do not try to make tactile drawings that show all three dimensions.

Instead, you can make tactile drawings of one or more cross-sectional planes of the 3-dimensional shape. See section on **3D geometry** above for how to do this.

### 3.7 Tables

Useful for: Blind, Low vision

This chapter describes how to adapt the notation of tables for braille readers. Students who have low vision may benefit from these adaptations too. Such students usually need more space to write numbers that they can read themselves, so bigger paper will help them too.

#### 3.7.1 Guidelines for teaching tables to braille readers

Working with tables takes a lot of time and effort for braille students. In braille, the students have no overview of the information that is in a table. While sighted students can find a specific cell at a glance, braille users have to navigate back and forth to read the corresponding column and row headers.

#### 3.7.2 Why tables are difficult for braille readers

As a small exercise to experience how hard it is to read a table in braille, find the frequency of blue light in this table (do not forget the correct units):

```
colour: wavelength [nm]: frequency [1015 Hz]
(infrared): > 760; < 0.395
red: 760 - 650; 0.395 - 0.461
orange: 650 - 590; 0.461 - 0.508
yellow: 590 - 570; 0.508 - 0.526
green: 570 - 510; 0.526 - 0.588
blue: 510 - 450; 0.588 - 0.666
violet: 450 - 400; 0.666 - 0.749
(ultraviolet): < 400; > 0.749
```

Table layout for conversion to braille.

You will immediately notice that this is far easier and faster for sighted people because the table layout makes it possible to find information quickly.

Colour	Wavelength [nm]:	Frequency [10 <sup>15</sup> Hz]
(Infrared)	> 760	< 0.395
Red	760 - 650	0.395 - 0.461
Orange	650 - 590	0.461 - 0.508
Yellow	590 - 570	0.508 - 0.526
Green	570 - 510	0.526 - 0.588
Blue	510 - 450	0.588 - 0.666
Violet	450 - 400	0.666 - 0.749
(Ultraviolet)	< 400	> 0.749

Table layout for sighted users.

Larger tables are totally unmanageable for braille readers: braille takes up far more space than print, and it is impossible to find a particular value from among the mass of numbers and signs.

**Adapting exercises**

Because of the time it takes to navigate a table, it is advisable to:

- Cut down the number of exercises.
- Select exercises that have compact and small tables. The bigger the table, the harder it is for braille students to grasp.
- Leave out columns and rows that are non-essential.
- Transpose the table (exchange the rows and columns).
- Use both the original and transposed tables so the student becomes familiar with both formats.

When a student uses transposed tables, they need to realize that columns and rows are interchanged. That can be very confusing in inclusive teaching. When the teacher is talking about a value in the third row, the braille reader needs to look for this value in the third column.

**Verbal support**

To help a student get an overview of a table, mention the following:

- The title of the table.
- The number of rows and columns.
- Whether the step-size is regular (e.g. 1), or irregular
- Whether the columns and rows are exchanged.

**A table as a substitute for a graph**

Sometimes it saves the teacher or the student time to make a table instead of drawing a tactile graph. See the section on **Graphs** for details.

**3.7.3**

**Tables in braille print**

A common way of writing a table for sighted readers is like this:

x	0	1	2	3	4
Y	0	81	324	729	1296

Braille readers usually transpose the table:

x; y	0	1	2	3	4
0; 0	0	81	324	729	1296
1; 81	0	81	324	729	1296
2; 324	0	81	324	729	1296
3; 729	0	81	324	729	1296
4; 1296	0	81	324	729	1296

The example above uses a semicolon ⠠⠨ between different cells. A comma ⠠⠴ may be used instead.

### Why braille readers work with transposed tables

In braille, this table

x	0	1	2	3	4
y	0	81	324	729	1296

would look like this:

x 0 1 2 3 4  
y 0 81 324 729 1296

In such a table it is hard to match the y values with the corresponding x values.

If the x and y values are aligned, the table looks like this:

x	0	1	2	3	4
y	0	81	324	729	1296

For a student, it would be difficult to align the x and y values because it requires a lot of thinking ahead about the number of braille symbols needed for each entry.

Another disadvantage of the usual (non-transposed) way is that the braille symbols take up a lot of space, especially because every number is preceded by a number symbol  $\dots$ . This means that the number of columns that can be displayed is very limited.

So braille readers transpose tables because:

- Reading corresponding x and y values is easy.
- It does not require layout.
- It works with tables that have large numbers or many columns in their non-transposed form.

Transposing tables has disadvantages:

- Transposing is a lot of work, and it is easy to make errors.
- The student's sighted classmates use the non-transposed tables. This can be confusing if the teacher refers to "column 3", for example. The student must instead look for row 3.



### 3.7.4

#### Tables for computer users

This section covers tables in word processor and spreadsheet software.

#### Reading tables in word processor software

The most common word processor programs are Microsoft Word, Google Docs, LibreOffice Writer and Apple Pages.

Most braille students can navigate tables in a common digital format, such as:

x	0	1	2	3	4
Y	0	81	324	729	1296

But this notation has a disadvantage for braille students because the accessibility software (NVDA, Jaws and Supernova are the most common) usually reads only one cell at a time. Students will have to navigate back and forth through the table to read the headers. This consumes a lot of time and energy.

Keyboard shortcuts or “hot keys” can make it easier to navigate a table. For Microsoft Word, useful shortcuts are:

#### Within a cell:

Next / previous character

<left arrow> / <right arrow>

Next / previous word

<ctrl> + <left arrow> / <right arrow>

#### Navigating to other cells:

Cell to the right / left

<tab> / <shift> + <tab>

Cell up / down

<up arrow> / <down arrow>

#### Navigating to the borders of the table:

To the first cell in a row

<alt> + <home>

To the last cell in a row

<alt> + <end>

To the first cell in a column

<alt> + <page up>

To the last cell in a column

<alt> + <page down>

#### Transposed tables in word processor programs

As explained above, blind students often prefer to read tables in the transposed form.

For students who are first introduced to working with tables in a word processor, it is advisable to start with transposed tables. This is because they correspond to the way tables are read in braille, and because transposed tables demand fewer computer skills.

It is important for advanced maths students to learn to work with the same table layout as sighted people, because this will increase their chances of success in their studies and careers.

### Making tables in a word processor

Blind students can learn how to work with tables in a word processor. Because they cannot visually navigate the menus, they will have to use keyboard shortcuts.

Every word processor software has its own keyboard shortcuts. You can find them in the help files of the word processor or online.

There are two ways to insert a table in Microsoft Word using keyboard shortcuts. Blind students can use either.

Press **<alt>** to enter the menu, use the **<right arrow>** to navigate to the Insert menu. Press **<enter>**.  
 Use the **<right arrow>** to navigate to Table and press **<enter>**  
 Use **<tab>** to navigate to Insert table and press **<enter>**  
 Enter the settings, using **<tab>** to navigate between fields. Then navigate to OK and press **<enter>**.

The second method:

Use **<alt> + Q** to access the search menu  
 Type: **table**  
 Use the **arrows** and **<tab>** to navigate to Insert table and press **<enter>**  
 Enter the settings, using **<tab>** to navigate between fields. Then navigate to OK and press **<enter>**.

### Tables in spreadsheet software

Tables in spreadsheet software such as Microsoft Excel are usually easier to navigate for blind learners than tables in a word processor. This is because it only takes one tap on an arrow key to move one cell left or right.

A second advantage is that the student can use functions, such as sum, average and sqrt, to do calculations, without using a separate calculator.

### Keyboard shortcuts for navigation in Excel tables

Teach your student these shortcuts to help them navigate around big tables:

<b>&lt;ctrl&gt; + F</b>	find a cell that contains a specific word or number
<b>&lt;ctrl&gt; + G</b>	move to a specific cell, e.g. C12
<b>&lt;ctrl&gt; + &lt;home&gt;</b>	move to cell A1
<b>&lt;ctrl&gt; + &lt;end&gt;</b>	move to the last cell in a table (the lower right cell)
<b>&lt;ctrl&gt; + &lt;arrow&gt;</b>	move to the last cell in a series that still does (or does not) contain data

### Freeze headers

If possible, freeze the column and row headings for large tables. If you scroll down or to the right, the headings will stay visible. In Excel, that works like this: select the View menu and click the Freeze Panes drop-down menu. Select Freeze top row, Freeze first column, or both.

### Additional options in accessibility software

Most accessibility software programs can read the content of a cell and subsequently both the corresponding column and row headers. Manuals supplied by the software makers explain the possibilities. Online tutorials, found on the internet or YouTube, can be an even easier way to learn these skills.

### Examples from Jaws accessibility software in Excel

To read row and column headers, press:

<insert> + <alt> + <shift> + R	to read row headers
<insert> + <alt> + <shift> + C	to read column headers

Jaws will automatically read headers when they are defined by the user. You can define headers when the cursor is in the upper left cell of the table (<ctrl> + <home> usually gets you there):

<insert> + <alt> + <ctrl> + C	to define column headers
<insert> + <alt> + <ctrl> + R	to define row headers

Jaws will now read row headers when the student changes rows, and column headers when the student changes columns.

## 3.8 Probability

Useful for: Blind, Low vision, Sighted

### 3.8.1 Equipment

The concepts of probability are best introduced using practical examples.

**Tossing a coin.** The two sides of a coin are impossible for blind and visually impaired learners to distinguish. So mark them some way: with paint for learners with low vision, or a drop of candlewax or adhesive braille labels for blind learners. Or use a wooden disk (larger than a coin) with different colours on each side.

Instead of tossing the coin and having it land where the learner cannot find it, put it into a container with a lid, shake the container, and then take the lid off.



Mark one side of a coin with a blob of candlewax and put it into a container to “toss” it.

**Matchsticks.** Take several matchsticks and break off the end of one (or more). Hold all the matchsticks in your hand, so the learners cannot see (or feel) which one is the longest. What is the chance of someone choosing a short (or a long) one?



One short match: what is the probability of choosing it?

**Throwing a dice.** You can buy tactile dice with raised dots on the surface. Have the students throw them into an open container so they do not fall on the floor.



Commercially available tactile dice.

**Cube frame cubes.** The cube frame cubes have six different faces (see **Part 2: Cube frame or cubarithm**) and can be used as dice.

**Choosing marbles or balls.** Learners with low vision enjoy picking differently coloured balls from a container. For example, if there are 10 yellow tennis balls, 15 blue balls and 20 green balls in a basket, you can ask the learner to pick two balls at random, then determine the probability that both will be a particular colour.

**Choosing playing cards.** A standard set of playing cards contains 52 cards: 13 of each suit (diamonds, hearts, clubs and spades). You can get tactile playing cards, or you can make your own by adding braille to a normal set. Or cut out and make your own cards and add braille to them. To make them easier to orient, cut off one corner of the cards, or punch a hole in them.



Playing cards with large print and braille for users who are blind or visually impaired.

**Braille cells.** The braille cell (**Part 2: Braille**) can have any of 64 different dot patterns (including the empty cell). Blind students will be very familiar with this, and you can use it to teach probabilities. See below for an example. Using the braille cell in this way is also a good opportunity to familiarize sighted students with braille.

**Taylor frame type.** A Taylor frame (**Part 2: Taylor frame**) comes with two forms of type (arithmetic and algebra), each of which has two ends, and with can be placed in the Taylor frame in any of eight different orientations. That gives  $2 * 2 * 8 = 32$  different possibilities. See below for an example.

### 3.8.2 Calculating probabilities using a braille cell

Useful for: Blind, Low vision, Sighted



The exercises below are also useful to introduce braille to sighted students.

What is the probability of obtaining the letter y  if one dot from the braille cell is randomly removed?

For this problem, we have to find out how many possible braille signs have five of the six dots. Here are the possibilities:



There are six possibilities in all. Only one of them is the letter y .  
The probability of obtaining a y =  $1/6$ .

What is the probability of obtaining either a q  or a y  from the same set of signs?

Hence, the probability of obtaining one of these letters from this set =  $2/6 = 1/3$ .

We can also start off with the set of braille signs with with three dots. There are 20 such possibilities:

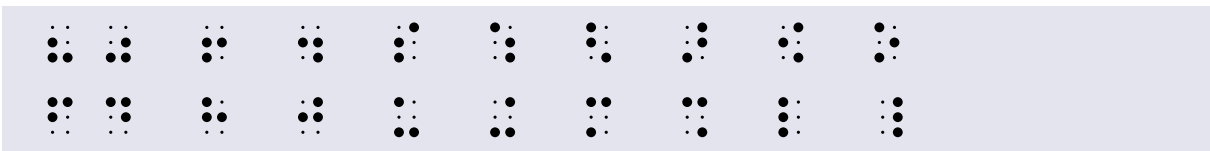

We can now work out various probabilities from these signs.

What is the probability of obtaining a **lower braille sign** from this set? (A lower braille sign does not have either of the two top dots.)

In this case, there are only four possibilities:



The probability of obtaining a lower braille sign =  $4/20 = 1/5$ .

What is the probability of obtaining an **upper braille sign** from this set? (An upper braille sign has at least one of the two top dots in it.)

We can calculate the probability of obtaining an upper braille sign in two ways:  
By counting the number of upper signs in the set:

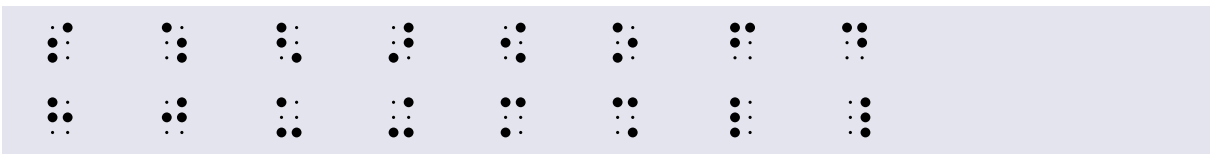

There are 16 such signs. So the probability of obtaining an upper sign =  $16/20 = 4/5$ .

Alternatively, we can remember that an upper sign cannot also be a lower sign. So we can subtract the probability of getting a lower sign from 1. This gives us  $1 - 1/5 = 4/5$ .

What is the probability of obtaining a **letter of the braille alphabet** from this set?

There are 9 letters of the braille alphabet in the set. These are:



The probability of obtaining a letter of the braille alphabet from this set =  $9/20$ .

### Calculating permutations using a Taylor frame

A permutation is the number of possible ways of ordering a set of items. For example:

We have four letters, A, B, C, and D. How many different ways can we write any two of these letters?

Let us first write down all the possibilities.

AB	AC	AD	BC	BD	CD
BA	CA	DA	CB	DB	DC

We can also write this as follows:

--	AB	AC	AD
BA	--	BC	BD
CA	CB	--	CD
DA	DB	DC	--

There are 12 permutations in total.  
 These are the Taylor frame type for A, B, C and D.

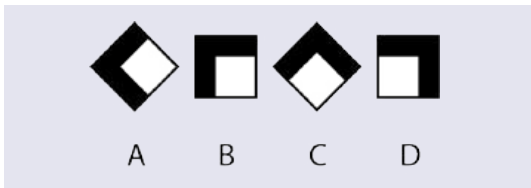

Here are the permutations on the Taylor frame:

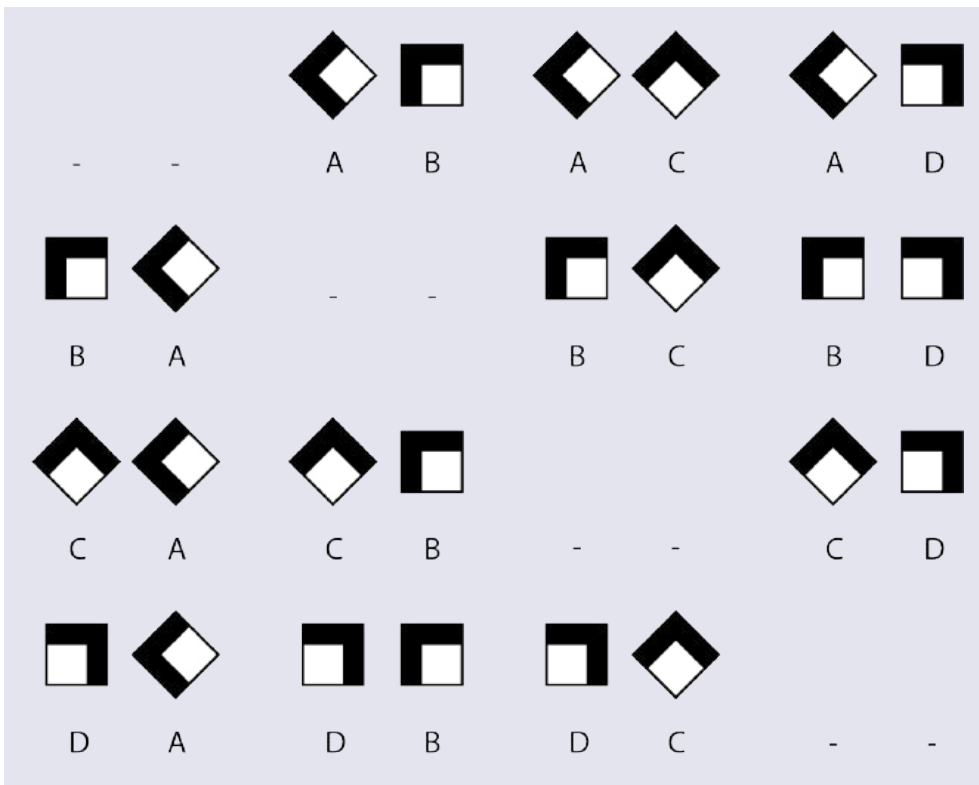

### 3.8.3 Braille

Once the students have grasped the concepts of probabilities, you can shift to using braille for presenting formulas and providing exercises. For probabilities, the students will especially use the concepts of algebra, factorials, fractions and brackets.

$$P(A) = \frac{m}{n}$$

In braille this is written as follows. Note the use of the following:

parentheses ⠠⠠ and ⠠⠠

Grade 1 passage indicator ⠠⠠

general fraction indicators ⠠⠠ and ⠠⠠

fraction line symbol ⠠⠠

P(A) = [m/n]

The number of permutations of n items, taken r at a time =  $\frac{n!}{(n-r)!}$

Written in braille as follows.

[n!/(n-r)!]

#### More information

APH Tactile graphic image library. Statistics and probability. (Requires free registration; uses Nemeth notation) <https://imagelibrary.aph.org/portals/aphb/#category/87>

ICEVI, Overbrook School of the Blind, and Nippon Foundation. 2005. Mathematics made easy for children with visual impairment. ON-NET and ICEVI.



### 3.9 Statistics

Statistics usually involves working with a lot of numbers. This can be difficult: students with low vision may not be able to hold a column of figures in their field of vision, while blind students may find it difficult to keep their place. Both can mark their place with a pushpin, a loop of masking tape or a magnet.

On the other hand, blind and visually impaired students often develop better memory and mental arithmetic skills than their sighted peers. This may mean they can work as quickly and accurately as their classmates.

Braille users will need to practise reading (and holding their place) in a set of figures with one hand, and entering numbers into a calculator, computer or abacus with the other.

A calculator, computer or abacus is useful for adding up and subtracting figures, and for calculating squares and square roots. Because of the additional challenges that blind and visually impaired learners face, and the likelihood of their making a calculation error, it may be advisable to allow them to skip some stages of the calculation. Make sure, however, that they have understood the principles involved. For example, instead of requiring them to add up a column of figures to calculate the mean, you can ask them to tell you what they would do. If they answer correctly "add up all the values of  $x$  and divide by the number of  $x$ s", then you know they have understood the concept. You can then give them the correct answer.

#### 3.9.1 Count

**Objects.** Give the student a set of objects, and ask them to count them. This is the count, or  $n$ . Explain that this is an important number that we will use again and again in statistics.

#### 3.9.2 Median

The median is the middle one of a group of numbers when they are ranked from smallest to largest. You can illustrate this in various ways:

**Length of objects.** Give the learner a handful of pencils of different lengths. Ask them to order them from shortest to longest, then find the one in the middle – and measure its length.



The median pencil is the red one, fifth from the top (and from the bottom).

**Flashcards.** Make a set of flashcards, with a braille number on each one. Some of the numbers can be the same. Give them to the student and ask them to sort them into order, from smallest to largest. The card in the middle is the median.

### 3.9.3

#### Range

**Length of objects.** Ask the learner to measure the length of the longest pencil, and the length of the shortest one, then to subtract one from the other. This is the range.

**Flashcards.** Ask the student to subtract the smallest number from the largest number. This is the range.

### 3.9.4

#### Mean

Practise several ways of calculating the mean.

**Using objects.** For small numbers, you can use Lego. Ask the student to make columns of Lego bricks on a baseboard to represent each of the numbers to find the mean of. They should then move the bricks from the tops of the longest columns to the shortest columns, so as to make all the columns the same height. Then count the number of bricks in one of the columns. This is the mean.

Make sure the result will be a whole number (you cannot break the bricks into pieces).

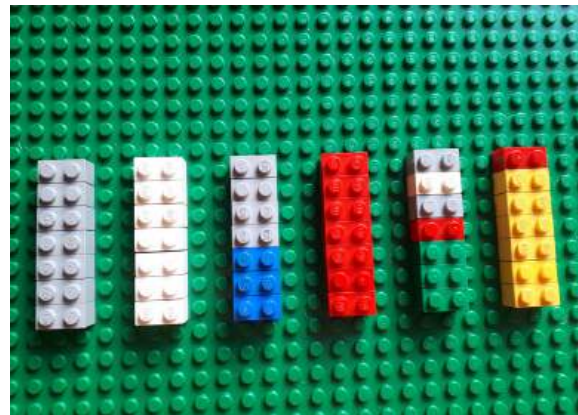
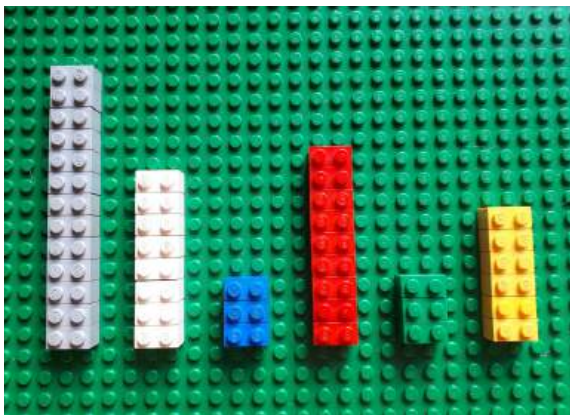

Calculating the mean of the numbers 13, 8, 3, 9, 3, 6 using Lego (left). Answer (right) = 7.

You can use a similar approach using bowls of dried beans or other small objects, or an abacus or Taylor frame.

**Combining and distributing.** Give the learner a sorting tray with a given number of dried beans in each compartment to represent the numbers to find the mean of. The learner can empty the whole tray, combine the beans, then redistribute them one by one into the compartments, so there is an equal number of beans in each compartment. Count the number of beans in one of the compartments. This is the mean.

Make sure the result will be a whole number (you cannot break beans into pieces).



Calculating the mean of the numbers 0, 3, 4, 2, 4, 1, 5, 4 using a tray and beans (left).  
Redistribute the beans to find the answer = 3 (right).

**Summing and dividing.** Tell the learner to sum all the pieces of Lego (or beans). They can do this by counting them all, or by mentally summing them. They then divide this sum by the number of groups. This is the mean.

**Abacus.** The abacus (see **Part 2: Abacus**) can be used to calculate the mean in two ways.

- In the same way as in the Lego example above. Set each number on a different rod on the abacus, then remove beads from one rod and add them to another one until all the rods have the same number of beads.
- By adding the numbers sequentially to obtain the total, then dividing by the count.

**Calculation shortcuts.** For large numbers, it can be tedious (and lead to errors) to add up a lot of figures. It is easier and faster to subtract a base number, then do the calculation.

**Example:** Find the mean of these children's heights (in centimetres): 103, 115, 104, 118, 110.

Instead of adding these numbers up and dividing the sum by 5 (the number of children), we can just trim a base number (100) off each number, add up the remainders, divide by 5, and add the 100 back on again:

Calculate the mean of these numbers: 103, 115, 104, 118, 110

Trim 100 from each number, then add what is left over.

$$3 + 15 + 4 + 18 + 10 = 50$$

Divide by the number of items.

$$50/5 = 10$$

Add the 100 back on to the answer.

$$10 + 100 = 110$$

Mean = 110.

**Calculator.** On a simple calculator, add up all the numbers and divide by the count. Some scientific calculators (but not the calculator that comes with recent versions of Windows) have a statistical mode that allows you to calculate the mean, standard deviation and other measures.

**Spreadsheet program.** Excel and other spreadsheet programs can calculate the mean of a set of figures. In Excel, the function is =AVERAGE().

### 3.9.5 Mode

The mode is the most common item in a set of objects or numbers.

**Objects.** Give the student a set of small objects, such as Lego bricks of different sizes, or pieces of card with different shapes (square, circle, triangle, etc.). Ask them to find out which type of object is the most common. This is the modal object.

**Flashcards.** Give the student the set of flashcards. Ask them to say which number appears on the largest number of flashcards. This is the mode.

Point out that the mean, median and mode may be different values. Explain that there may be more than one mode: if two or more numbers appear with the same high frequency.

**Spreadsheet program.** In Excel, the function is =MODE().

### 3.9.6 Frequency

**Objects.** Ask the student to write down the number of times each type of Lego brick (or card with a particular shape) occurs. This is its frequency.

**Flashcards.** Ask the student to write down on how many cards each number appears. This is the frequency of that number.

**Spreadsheet program.** In Excel, the function is =FREQUENCY().

### 3.9.7 Graphs

See the **Graphs** section for ideas on how to create tactile graphs such as histograms and frequency charts for blind and visually impaired learners, and for how they can create such graphs themselves.

Tactile graphs are useful for teaching and reinforcing statistical concepts such as maximum, minimum, range, mean, mode, median, and standard deviation.

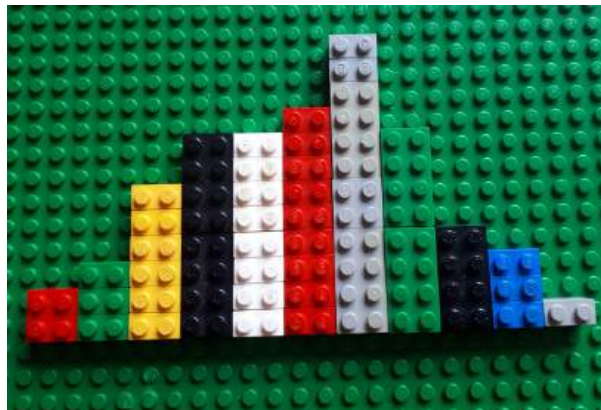
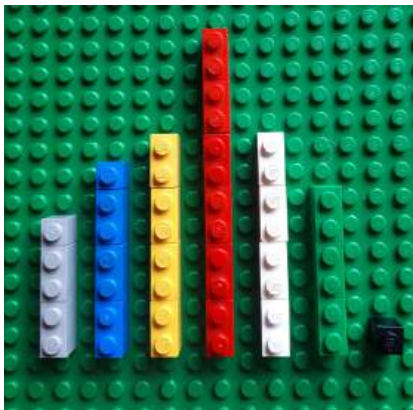

Lego graphs to show frequency. The graph on the left is easier to read tactilely because it has gaps between the bars.

The full braille cell  $\begin{smallmatrix} \bullet & \bullet \\ \bullet & \bullet \end{smallmatrix}$  can be used to make bar charts.

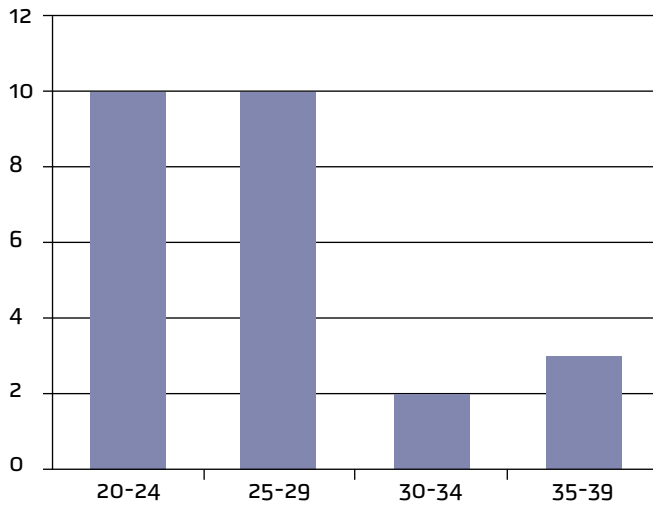

The equivalent in braille looks like this. The graph has been transposed to make it easier to write and read.

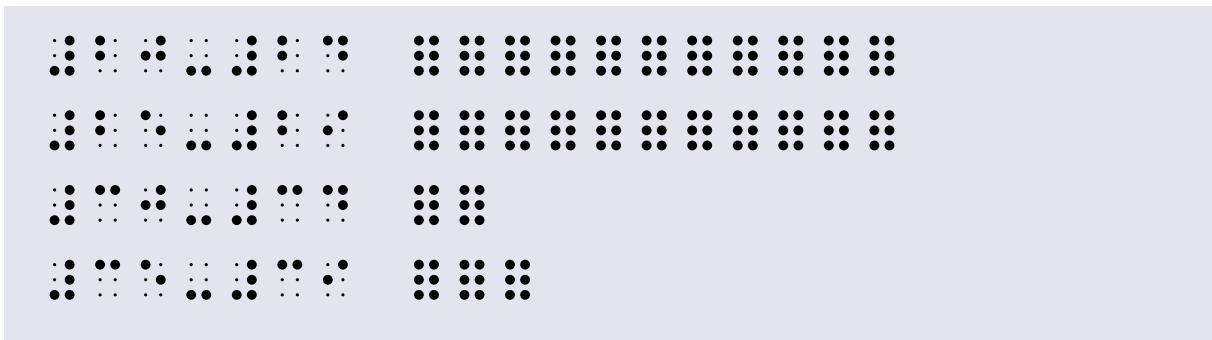

A cube frame (see **Part 2: Cube frame or cubarithm**), Taylor frame (**Part 2: Taylor frame**) or geoboard can be used to create graphs.

Tactile graphs should be kept simple and uncluttered. See **Part 2: Drawings and graphs** for guidelines.

small standard deviation

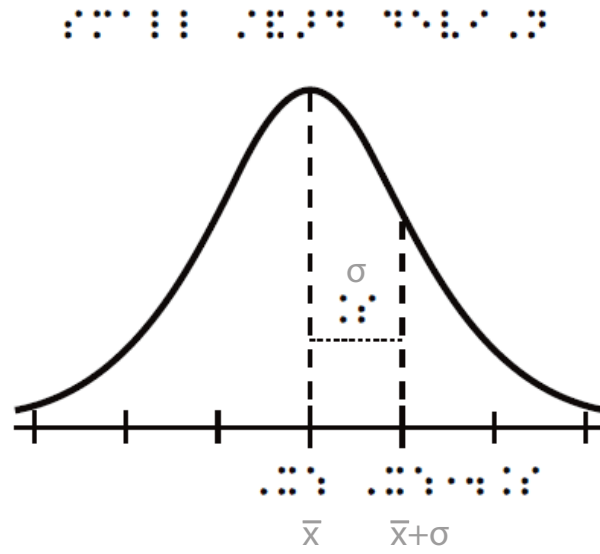

large standard deviation

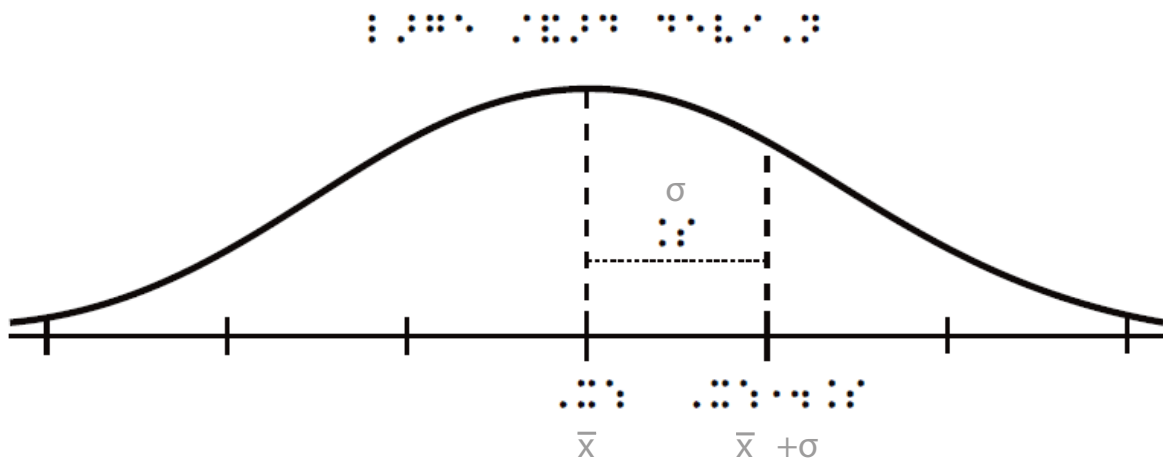

Example of a tactile graph. Small standard deviation (top) and large standard deviation (bottom).

**3.9.8**  
**Braille**

Braille notation for statistics can get complicated because of the need for bars, superscripts, subscripts, roots and Greek letters. For example:

$\bar{x} = \sum x/n$	
$\sum_{x=1}^n x^2$	

### 3.9.9

#### Statistical tables

Statistics sometimes requires learners to look up values in tables that have large numbers of entries. Examples are chi-squared, normal, t and F distributions.

It is unrealistic to expect blind and visually impaired students to use such tables (see the section on **Tables**). Instead, consider:

- Using a calculator or computer to find the correct values. If necessary, a classmate can read the values out to the blind and visually impaired student.
- Asking the student to state the number they wish to look up (e.g., “the value of chi-squared for 5 degrees of freedom at a 95% significance level”), then giving them the correct value.

#### More information

APH Tactile graphic image library. Statistics and probability. (Requires free registration; uses Nemeth notation) <https://imagelibrary.aph.org/portals/aphb/#category/87>

Pandey, P., and Pandey, M.M. 2015. Research methodology: Tools and techniques. Buzau (Romania): Bridge Center.

Willings, C. Teaching students with visual impairments: Measurement & data collection. <https://www.teachingvisuallyimpaired.com/measurement--data.html>

**Koninklijke Visio**  
Centre of Expertise  
for partially sighted  
and blind people

**[www.visio.org](http://www.visio.org)**